

E5CN
E5AN
E5EN
E5GN

Digital Temperature Controllers

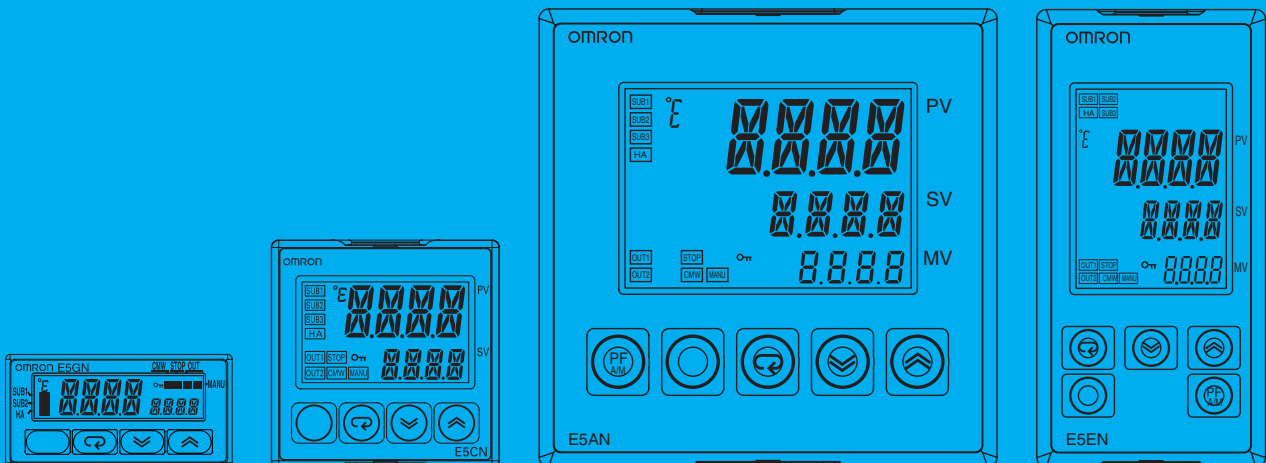

User's Manual Basic Type

E5CN/E5AN/E5EN/E5GN

Digital Temperature Controllers

User's Manual

Basic Type

Revised September 2009

Preface

The E5CN, E5CN-U, E5AN, E5EN, and E5GN are Digital Temperature Controllers. The E5CN and E5CN-U are both compact temperature controllers, with the E5CN featuring screw terminal connections, and the E5CN-U featuring socket pin connections. The E5GN can be connected using screw terminals or screwless clamp terminals. The main functions and characteristics of these Digital Temperature Controllers are as follows:

- Any of the following types of input can be used: thermocouple, platinum resistance thermometer, infrared sensor, analog voltage, or analog current.
- Either standard or heating/cooling control can be performed.
- Both auto-tuning and self-tuning are supported.
- Event inputs can be used to switch set points (multi-SP function), switch between RUN and STOP status, switch between automatic and manual operation, start/reset the simple program function, and perform other operations. (Event inputs are not applicable to the E5CN-U.)
- Heater burnout detection, heater short (HS) alarms, and heater overcurrent (OC) functions are supported. (Applicable to E5CN, E5AN, E5EN, and E5GN models with heater burnout detection function.)
- Communications are supported. (Applicable to E5CN, E5AN, E5EN, and E5GN models with communications.)
- User calibration of the sensor input is supported.
- The structure is waterproof (IP66). (Not applicable to the E5CN-U.)
- Conforms to UL, CSA, and IEC safety standards and EMC Directive.
- The PV display color can be switched to make process status easy to understand at a glance.

This manual describes the E5CN, E5CN-U, E5AN, E5EN, and E5GN. Read this manual thoroughly and be sure you understand it before attempting to use the Digital Temperature Controller and use the Digital Temperature Controller correctly according to the information provided. Keep this manual in a safe place for easy reference. Refer to the following manual for further information on communications: *E5CN/E5AN/E5EN/E5GN Digital Temperature Controllers Communications Manual Basic Type* (Cat. No. H158).

Refer to the following manual for information on the Advanced Type Controllers: *E5CN/E5AN/E5EN-H Digital Temperature Controllers User's Manual Advanced Type* (Cat. No. H157).

Visual Aids

The following headings appear in the left column of the manual to help you locate different types of information.

Note Indicates information of particular interest for efficient and convenient operation of the product.

1,2,3... 1. Indicates lists of one sort or another, such as procedures, checklists, etc.

© OMRON, 2008

All rights reserved. No part of this publication may be reproduced, stored in a retrieval system, or transmitted, in any form, or by any means, mechanical, electronic, photocopying, recording, or otherwise, without the prior written permission of OMRON.

No patent liability is assumed with respect to the use of the information contained herein. Moreover, because OMRON is constantly striving to improve its high-quality products, the information contained in this manual is subject to change without notice. Every precaution has been taken in the preparation of this manual. Nevertheless, OMRON assumes no responsibility for errors or omissions. Neither is any liability assumed for damages resulting from the use of the information contained in this publication.

Read and Understand this Manual

Please read and understand this manual before using the products. Please consult your OMRON representative if you have any questions or comments.

Warranty, Limitations of Liability

WARRANTY

OMRON's exclusive warranty is that the products are free from defects in materials and workmanship for a period of one year (or other period if specified) from date of sale by OMRON.

OMRON MAKES NO WARRANTY OR REPRESENTATION, EXPRESS OR IMPLIED, REGARDING NON-INFRINGEMENT, MERCHANTABILITY, OR FITNESS FOR PARTICULAR PURPOSE OF THE PRODUCTS. ANY BUYER OR USER ACKNOWLEDGES THAT THE BUYER OR USER ALONE HAS DETERMINED THAT THE PRODUCTS WILL SUITABLY MEET THE REQUIREMENTS OF THEIR INTENDED USE. OMRON DISCLAIMS ALL OTHER WARRANTIES, EXPRESS OR IMPLIED.

LIMITATIONS OF LIABILITY

OMRON SHALL NOT BE RESPONSIBLE FOR SPECIAL, INDIRECT, OR CONSEQUENTIAL DAMAGES, LOSS OF PROFITS OR COMMERCIAL LOSS IN ANY WAY CONNECTED WITH THE PRODUCTS, WHETHER SUCH CLAIM IS BASED ON CONTRACT, WARRANTY, NEGLIGENCE, OR STRICT LIABILITY.

In no event shall the responsibility of OMRON for any act exceed the individual price of the product on which liability is asserted.

IN NO EVENT SHALL OMRON BE RESPONSIBLE FOR WARRANTY, REPAIR, OR OTHER CLAIMS REGARDING THE PRODUCTS UNLESS OMRON'S ANALYSIS CONFIRMS THAT THE PRODUCTS WERE PROPERLY HANDLED, STORED, INSTALLED, AND MAINTAINED AND NOT SUBJECT TO CONTAMINATION, ABUSE, MISUSE, OR INAPPROPRIATE MODIFICATION OR REPAIR.

Application Considerations

SUITABILITY FOR USE

OMRON shall not be responsible for conformity with any standards, codes, or regulations that apply to the combination of the products in the customer's application or use of the products.

At the customer's request, OMRON will provide applicable third party certification documents identifying ratings and limitations of use that apply to the products. This information by itself is not sufficient for a complete determination of the suitability of the products in combination with the end product, machine, system, or other application or use.

The following are some examples of applications for which particular attention must be given. This is not intended to be an exhaustive list of all possible uses of the products, nor is it intended to imply that the uses listed may be suitable for the products:

- Outdoor use, uses involving potential chemical contamination or electrical interference, or conditions or uses not described in this manual.
- Nuclear energy control systems, combustion systems, railroad systems, aviation systems, medical equipment, amusement machines, vehicles, safety equipment, and installations subject to separate industry or government regulations.
- Systems, machines, and equipment that could present a risk to life or property.

Please know and observe all prohibitions of use applicable to the products.

NEVER USE THE PRODUCTS FOR AN APPLICATION INVOLVING SERIOUS RISK TO LIFE OR PROPERTY WITHOUT ENSURING THAT THE SYSTEM AS A WHOLE HAS BEEN DESIGNED TO ADDRESS THE RISKS, AND THAT THE OMRON PRODUCTS ARE PROPERLY RATED AND INSTALLED FOR THE INTENDED USE WITHIN THE OVERALL EQUIPMENT OR SYSTEM.

PROGRAMMABLE PRODUCTS

OMRON shall not be responsible for the user's programming of a programmable product, or any consequence thereof.

Disclaimers

CHANGE IN SPECIFICATIONS

Product specifications and accessories may be changed at any time based on improvements and other reasons.

It is our practice to change model numbers when published ratings or features are changed, or when significant construction changes are made. However, some specifications of the products may be changed without any notice. When in doubt, special model numbers may be assigned to fix or establish key specifications for your application on your request. Please consult with your OMRON representative at any time to confirm actual specifications of purchased products.

DIMENSIONS AND WEIGHTS

Dimensions and weights are nominal and are not to be used for manufacturing purposes, even when tolerances are shown.

PERFORMANCE DATA

Performance data given in this manual is provided as a guide for the user in determining suitability and does not constitute a warranty. It may represent the result of OMRON's test conditions, and the users must correlate it to actual application requirements. Actual performance is subject to the OMRON Warranty and Limitations of Liability.

ERRORS AND OMISSIONS

The information in this manual has been carefully checked and is believed to be accurate; however, no responsibility is assumed for clerical, typographical, or proofreading errors, or omissions.

Safety Precautions

■ Definition of Precautionary Information

The following notation is used in this manual to provide precautions required to ensure safe usage of the product.





The safety precautions that are provided are extremely important to safety. Always read and heed the information provided in all safety precautions.

The following notation is used.







Indicates a potentially hazardous situation which, if not avoided, is likely to result in minor or moderate injury or in property damage.

■ Symbols

	Symbol	Meaning
Caution		General Caution Indicates non-specific general cautions, warnings, and dangers.
		Electrical Shock Caution Indicates possibility of electric shock under specific conditions.
Prohibition		General Prohibition Indicates non-specific general prohibitions.
Mandatory Caution		General Caution Indicates non-specific general cautions, warnings, and dangers.

■ Safety Precautions

 CAUTION	
Do not touch the terminals while power is being supplied. Doing so may occasionally result in minor injury due to electric shock.	
Do not allow pieces of metal, wire clippings, or fine metallic shavings or filings from installation to enter the product. Doing so may occasionally result in electric shock, fire, or malfunction.	
Do not use the product where subject to flammable or explosive gas. Otherwise, minor injury from explosion may occasionally occur.	
Never disassemble, modify, or repair the product or touch any of the internal parts. Minor electric shock, fire, or malfunction may occasionally occur.	
<p>CAUTION - Risk of Fire and Electric Shock</p> <p>a) This product is UL listed as Open Type Process Control Equipment. It must be mounted in an enclosure that does not allow fire to escape externally.</p> <p>b) More than one disconnect switch may be required to de-energize the equipment before servicing the product.</p> <p>c) Signal inputs are SELV, limited energy. ^{*1}</p> <p>d) Caution: To reduce the risk of fire or electric shock, do not interconnect the outputs of different Class 2 circuits. ^{*2}</p>	
<p>If the output relays are used past their life expectancy, contact fusing or burning may occasionally occur.</p> <p>Always consider the application conditions and use the output relays within their rated load and electrical life expectancy. The life expectancy of output relays varies considerably with the output load and switching conditions.</p>	

*1 A SELV circuit is one separated from the power supply with double insulation or reinforced insulation, that does not exceed 30 V r.m.s. and 42.4 V peak or 60 VDC.

*2 A class 2 power supply is one tested and certified by UL as having the current and voltage of the secondary output restricted to specific levels.

 **CAUTION**

Tighten the terminal screws to between 0.74 and 0.90 N·m. Loose screws may occasionally result in fire. *3

Set the parameters of the product so that they are suitable for the system being controlled. If they are not suitable, unexpected operation may occasionally result in property damage or accidents.

A malfunction in the Temperature Controller may occasionally make control operations impossible or prevent alarm outputs, resulting in property damage. To maintain safety in the event of malfunction of the Temperature Controller, take appropriate safety measures, such as installing a monitoring device on a separate line.

A semiconductor is used in the output section of long-life relays. If excessive noise or surge is impressed on the output terminals, a short-circuit failure is likely to occur. If the output remains shorted, fire will occur due to overheating of the heater or other cause. Take measures in the overall system to prevent excessive temperature increase and to prevent fire from spreading.

When inserting the body of the Temperature Controller into the case, confirm that the hooks on the top and bottom are securely engaged with the case. If the body of the Temperature Controller is not inserted properly, faulty contact in the terminal section or reduced water resistance may occasionally result in fire or malfunction.



*3 The tightening torque is 0.5 N·m for the E5CN-U and 0.43 to 0.58 N·m for the E5GN. The terminal torque is 0.5 to 0.6 N·m for auxiliary output 2 on the E5GN.

Precautions for Safe Use

Be sure to observe the following precautions to prevent operation failure, malfunction, or adverse affects on the performance and functions of the product. Not doing so may occasionally result in unexpected events. Use the product within the specifications.

- 1) The product is designed for indoor use only. Do not use the product outdoors or in any of the following locations. Do not use or store the product in any of the following locations.
 - Places directly subject to heat radiated from heating equipment.
 - Places subject to splashing liquid or oil atmosphere.
 - Places subject to direct sunlight.
 - Places subject to dust or corrosive gas (in particular, sulfide gas and ammonia gas).
 - Places subject to intense temperature change.
 - Places subject to icing and condensation.
 - Places subject to vibration and large shocks.
- 2) Use and store the Digital Temperature Controller within the rated ambient temperature and humidity. Gang-mounting two or more temperature controllers, or mounting temperature controllers above each other may cause heat to build up inside the temperature controllers, which will shorten their service life. In such a case, use forced cooling by fans or other means of air ventilation to cool down the Digital Temperature Controllers.
- 3) To allow heat to escape, do not block the area around the product. Do not block the ventilation holes on the product.
- 4) Be sure to wire properly with correct polarity of terminals.
- 5) Use the specified size of crimp terminals for the E5CN, E5AN, or E5EN (M3.5, width of 7.2 mm or less). For open-wired connections to the E5CN, E5AN, or E5EN, use stranded or solid copper wires with a gauge of AWG24 to AWG14 (equal to a cross-sectional area of 0.205 to 2.081 mm²). (The stripping length is 5 to 6 mm.) Up to two wires of the same size and type or two crimp terminals can be connected to one terminal. Do not connect more than two wires or more than two crimp terminals to the same terminal.

Use the specified size of crimp terminals for the E5GN (M3.0, width of 5.8 mm or less). For open-wired connections to the E5GN, use stranded or solid copper wires with a gauge of AWG24 to AWG18 (equal to a cross-sectional area of 0.205 to 0.8231 mm²). (The stripping length for screw terminals is 6 to 8 mm. The stripping length for screwless clamp terminals is 10 mm. The stripping length for auxiliary output 2 is 6 mm.) Up to two wires of the same size and type or two crimp terminals can be connected to one terminal. Do not connect more than two wires or more than two crimp terminals to the same terminal.

Ferrules for screwless clamp terminals must be 0.8 to 1.4 mm in diameter and the exposed conductor must be 8 to 12 mm in length. Ferrules for auxiliary output 2 must be 0.8 to 1.4 mm in diameter and the exposed conductor must be 6 mm in length.
- 6) Do not wire the terminals which are not used.
- 7) To avoid inductive noise, keep the wiring for the Digital Temperature Controller's terminal block away from power cables carry high voltages or large currents. Also, do not wire power lines together with or parallel to Digital Temperature Controller wiring. Using shielded cables and using separate conduits or ducts is recommended.

Attach a surge suppressor or noise filter to peripheral devices that generate noise (in particular, motors, transformers, solenoids, magnetic coils or other equipment that have an inductance component). When a noise filter is used at the power supply, first check the voltage or current, and attach the noise filter as close as possible to the temperature controller.

Allow as much space as possible between the Digital Temperature Controller and devices that generate powerful high frequencies (high-frequency welders, high-frequency sewing machines, etc.) or surge.
- 8) Use this product within the rated load and power supply.
- 9) Make sure that the rated voltage is attained within two seconds of turning ON the power using a switch or relay contact. If the voltage is applied gradually, the power may not be reset or output malfunctions may occur.

- 10) Make sure that the Temperature Controller has 30 minutes or more to warm up after turning ON the power before starting actual control operations to ensure the correct temperature display.
- 11) When executing self-tuning, turn ON power for the load (e.g., heater) at the same time as or before supplying power to the Digital Temperature Controller. If power is turned ON for the Digital Temperature Controller before turning ON power for the load, self-tuning will not be performed properly and optimum control will not be achieved.
- 12) A switch or circuit breaker should be provided close to this unit. The switch or circuit breaker should be within easy reach of the operator, and must be marked as a disconnecting means for this unit.
- 13) Always turn OFF the power supply before removing the body of the E5CN, E5AN, or E5EN from the case, and never touch nor apply shock to the terminals or electronic components. When inserting the interior of the product, do not allow the electronic components to touch the case.
Always turn OFF the power supply before removing the terminal block from the E5GN, and never touch nor apply shock to the terminals or electronic components.
- 14) Do not use paint thinner or similar chemical to clean with. Use standard grade alcohol.
- 15) Design system (control panel, etc.) considering the 2 second of delay that the controller's output to be set after power ON.
- 16) The output may turn OFF when shifting to certain levels. Take this into consideration when performing control.
- 17) The number of EEPROM write operations is limited. Therefore, use RAM write mode when frequently overwriting data during communications or other operations.
- 18) Always touch a grounded piece of metal before touching the Digital Temperature Controller to discharge static electricity from your body.
- 19) Do not remove the terminal block from the E5CN, E5AN, or E5EN. Doing so may result in failure or malfunction.
- 20) Control outputs that are voltage outputs are not isolated from the internal circuits. When using a grounded thermocouple, do not connect any of the control output terminals to ground. (Doing so may result in an unwanted circuit path, causing error in the measured temperature.)
- 21) When replacing the body of the E5CN, E5AN, or E5EN, check the condition of the terminals. If corroded terminals are used, contact failure in the terminals may cause the temperature inside the E5CN, E5AN, or E5EN to increase, possibly resulting in fire. If the terminals are corroded, replace the case as well.
When removing the terminal block of the E5GN to replace the Digital Temperature Controller, check the condition of the terminals. If corroded terminals are used, contact failure in the terminals may cause the temperature inside the Digital Temperature Controller to increase, possibly resulting in fire. If the terminals are corroded, replace the terminal block as well.
- 22) Use suitable tools when taking the Digital Temperature Controller apart for disposal. Sharp parts inside the Digital Temperature Controller may cause injury.
- 23) When applying Lloyd's standards, install the Digital Temperature Controller according to the requirements given in *Shipping Standards*.
- 24) Do not use the Temperature Controller if the front sheet is peeling off or torn.

● Service Life

Use the Temperature Controller within the following temperature and humidity ranges:

Temperature: -10 to 55°C (with no icing or condensation), Humidity: 25% to 85%

If the Controller is installed inside a control board, the ambient temperature must be kept to under 55°C, including the temperature around the Controller.

The service life of electronic devices like Temperature Controllers is determined not only by the number of times the relay is switched but also by the service life of internal electronic components. Component service life is affected by the ambient temperature: the higher the temperature, the shorter the service life and, the lower the temperature, the longer the service life. Therefore, the service life can be extended by lowering the temperature of the Temperature Controller.

When two or more Temperature Controllers are mounted horizontally close to each other or vertically next to one another, the internal temperature will increase due to heat radiated by the Temperature Controllers and the service life will decrease. In such a case, use forced cooling by fans or other means of air ventilation to cool down the Temperature Controllers. When providing forced cooling, however, be careful not to cool down the terminals sections alone to avoid measurement errors.

● Ambient Noise

To avoid inductive noise, keep the wiring for the Digital Temperature Controller's terminal block wiring away from power cables carrying high voltages or large currents. Also, do not wire power lines together with or parallel to Digital Temperature Controller wiring. Using shielded cables and using separate conduits or ducts is recommended.

Attach a surge suppressor or noise filter to peripheral devices that generate noise (in particular, motors, transformers, solenoids, magnetic coils or other equipment that have an inductance component). When a noise filter is used at the power supply, first check the voltage or current, and attach the noise filter as close as possible to the Temperature Controller.

Allow as much space as possible between the Digital Temperature Controller and devices that generate powerful high frequencies (high-frequency welders, high-frequency sewing machines, etc.) or surge.

● Ensuring Measurement Accuracy

When extending or connecting the thermocouple lead wire, be sure to use compensating wires that match the thermocouple types.

When extending or connecting the lead wire of the platinum resistance thermometer, be sure to use wires that have low resistance and keep the resistance of the three lead wires the same.

Mount the Temperature Controller so that it is horizontally level.

If the measurement accuracy is low, check to see if input shift has been set correctly.

● Waterproofing

The degree of protection is as shown below. Sections without any specification on their degree of protection or those with IP□0 are not waterproof.

Front panel: IP66

Rear case: IP20, Terminal section: IP00

(E5CN-U: Front panel: IP50, rear case: IP20, terminals: IP00)

Precautions for Operation

- 1) It takes approximately two seconds for the outputs to turn ON from after the power supply is turned ON. Due consideration must be given to this time when incorporating Temperature Controllers into a control panel or similar device.
- 2) Make sure that the Temperature Controller has 30 minutes or more to warm up after turning ON the power before starting actual control operations to ensure the correct temperature display.
- 3) When executing self-tuning, turn ON power for the load (e.g., heater) at the same time as or before supplying power to the Temperature Controller. If power is turned ON for the Temperature Controller before turning ON power for the load, self-tuning will not be performed properly and optimum control will not be achieved. When starting operation after the Temperature Controller has warmed up, turn OFF the power and then turn it ON again at the same time as turning ON power for the load. (Instead of turning the Temperature Controller OFF and ON again, switching from STOP mode to RUN mode can also be used.)
- 4) Avoid using the Controller in places near a radio, television set, or wireless installing. The Controller may cause radio disturbance for these devices.

Shipping Standards

The E5CN, E5CN-H, E5AN, E5AN-H, E5EN, and E5EN-H comply with Lloyd's standards. When applying the standards, the following installation and wiring requirements must be met in the application.

■ Application Conditions

1) Installation Location

The E5CN, E5CN-H, E5AN, E5AN-H, E5EN, and E5EN-H comply with installation category ENV1 and ENV2 of Lloyd's standards. Therefore, they must be installed in a location equipped with air conditioning. They must therefore be installed in a location equipped with air conditioning. They cannot be used on the bridge or decks, or in a location subject to strong vibration.

2) Wiring Conditions

Install the recommended ferrite core and wrap the line around it three turns for the applicable lines (e.g., power supply cable line and signal lines) of the models listed in the following table. (See illustrations.) Install the ferrite cores as close to the terminal block of the E5□N as possible. (As a guideline, the ferrite core should be within 10 cm of the terminal block.)

● Lines Requiring Ferrite Cores

Model	Signal and power lines provided with ferrite cores
E5CN, E5CN-U, or E5CN-H	Input power supply
E5EN, E5AN, E5EN-H, or E5AN-H	Input power supply and I/O lines (control outputs (1 and 2), communications, event inputs (1 to 4), transfer output, and external power supply (Advanced Type models do not have an external power supply.)

● Recommended Ferrite Core

Manufacturer	Seiwa Electric Mfg. Co., Ltd.
Model	E04RA310190100

● Ferrite Core Connection Examples

1. E5CN/E5CN-H

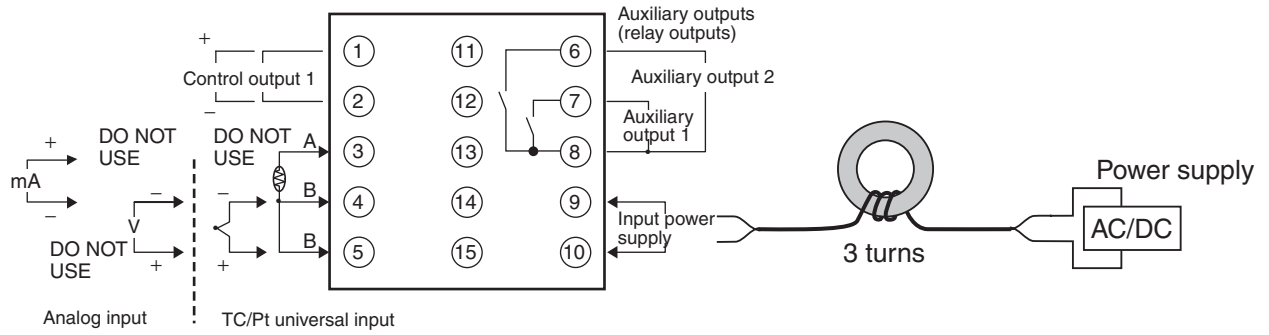

2. E5AN/E5EN/E5AN-H/E5EN-H

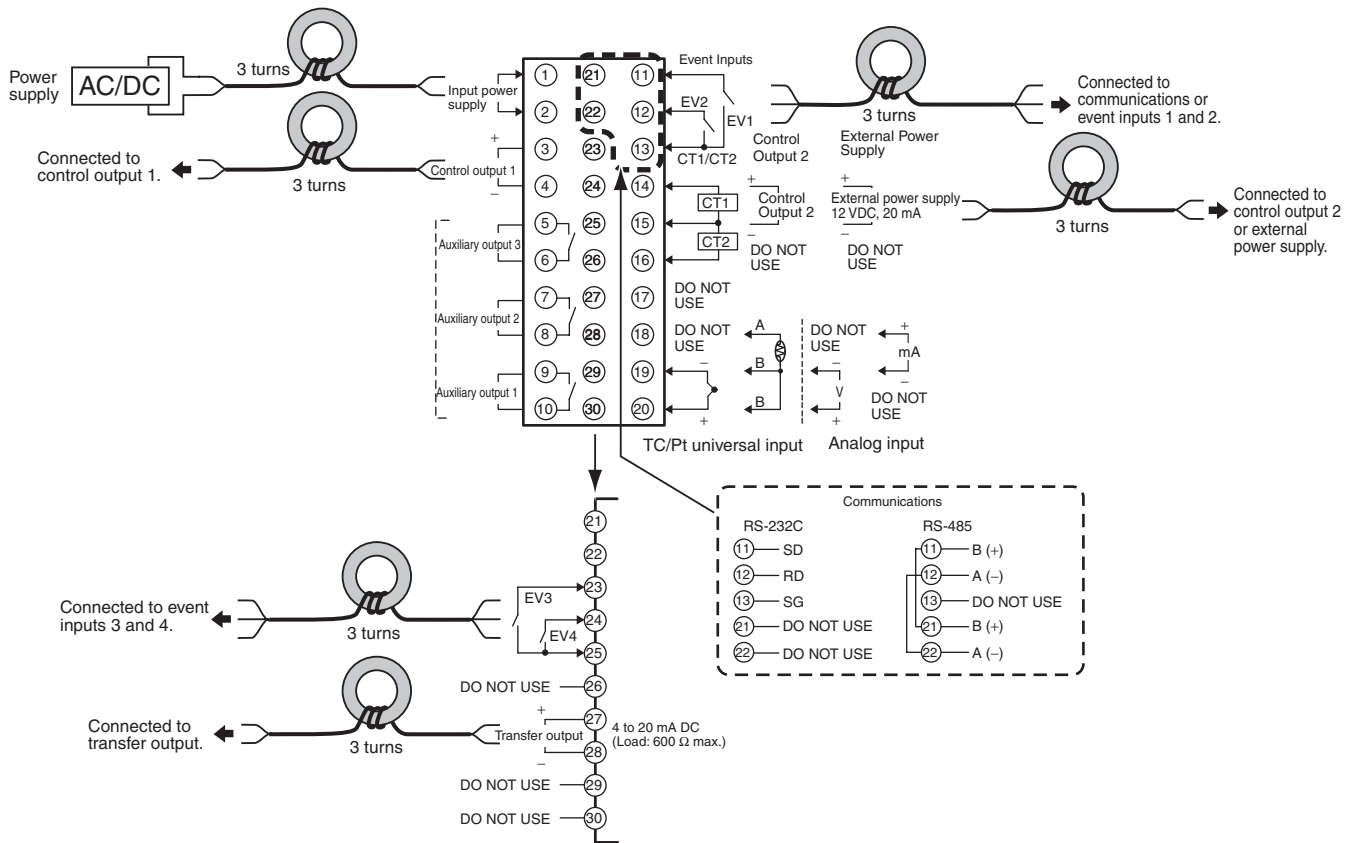

Preparations for Use

Be sure to thoroughly read and understand the manual provided with the product, and check the following points.

Timing	Check point	Details
Purchasing the product	Product appearance	After purchase, check that the product and packaging are not dented or otherwise damaged. Damaged internal parts may prevent optimum control.
	Product model and specifications	Make sure that the purchased product meets the required specifications.
Setting the Unit	Product installation location	Provide sufficient space around the product for heat dissipation. Do not block the vents on the product.
Wiring	Terminal wiring	Do not subject the terminal screws to excessive stress (force) when tightening them. Make sure that there are no loose screws after tightening terminal screws to the specified torque of 0.74 to 0.90 N·m (see note). Be sure to confirm the polarity for each terminal before wiring the terminal block and connectors.
	Power supply inputs	Wire the power supply inputs correctly. Incorrect wiring will result in damage to the internal circuits.
Operating environment	Ambient temperature	The ambient operating temperature for the product is -10 to 55°C (with no condensation or icing). To extend the service life of the product, install it in a location with an ambient temperature as low as possible. In locations exposed to high temperatures, if necessary, cool the products using a fan or other cooling method.
	Vibration and shock	Check whether the standards related to shock and vibration are satisfied at the installation environment. (Install the product in locations where the conductors will not be subject to vibration or shock.)
	Foreign particles	Install the product in a location that is not subject to liquid or foreign particles entering the product.

Note The tightening torque is 0.5 N·m for the E5CN-U and 0.43 to 0.58 N·m for the E5GN. The terminal torque is 0.5 to 0.6 N·m for auxiliary output 2 on the E5GN.

■ Upgraded Functions

The functionality of the E5CN, E5CN-U, E5AN, and E5EN was improved starting from December 2007 production.

The functionality of the E5GN was improved starting from August 2009 production.

The design of the front panel can be used to differentiate between the previous and upgraded models.

- E5CN/CN-U

The upgraded Controllers are basically compatible with the previous Controllers. Terminal arrangements, terminal sizes, and panel mounting depth have not been changed.

- E5AN/EN

Although the upgraded Controllers are compatible with the previous Controllers, terminal arrangements have been changed. Terminal sizes and panel mounting depth have not been changed.

- E5GN

Model numbers have changed accompanying the introduction of universal input capability. The default setting of the input type parameter of the E5GN-□□□P (models with resistance thermometers) has been changed from a Pt100 resistance thermometer to a K thermocouple. Make sure the setting of the input type parameter agrees with the temperature sensor that is being used.

The terminal block has also been changed, which means the wiring methods and terminal arrangement are different.

Other changes outlined in the following tables. Refer to relevant pages in the manual for details.

	Previous models	Upgraded models
E5CN/CN-U		<ul style="list-style-type: none"> • ALM indicator was changed to SUB indicator.
E5AN	<ul style="list-style-type: none"> • Number of displays: 2 (PV and SV) 	<ul style="list-style-type: none"> • Number of displays: 3 (PV, SV, and MV) * • ALM indicator was changed to SUB indicator.

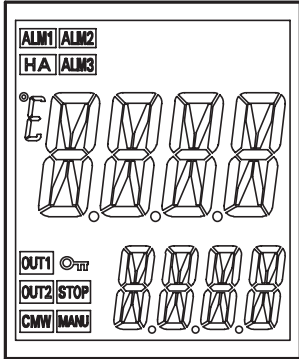
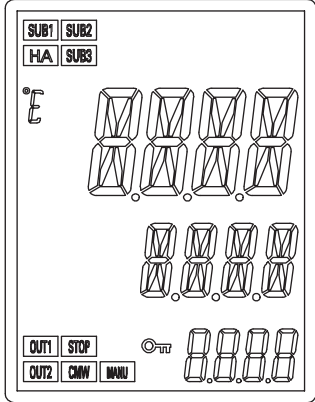
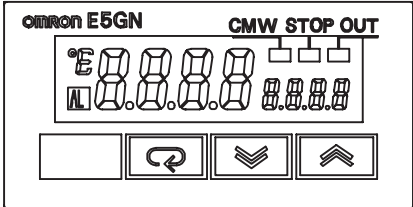
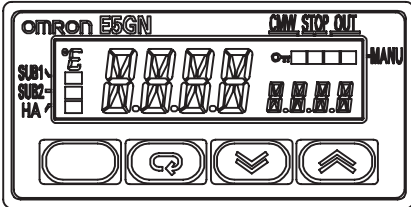
	Previous models	Upgraded models
E5EN	 <p>The diagram shows the display panel for previous E5EN models. It features two rows of indicators at the top: 'ALM1 ALM2' and 'HA ALM3'. Below these are four large 7-segment displays for PV and SV. At the bottom, there are three rows of indicators: 'OUT1' with a 'TIT' symbol, 'OUT2 STOP', and 'CMW MANU'. To the right of these are four smaller 7-segment displays.</p> <ul style="list-style-type: none"> • Number of displays: 2 (PV and SV) 	 <p>The diagram shows the display panel for upgraded E5EN models. It features two rows of indicators at the top: 'SUB1 SUB2' and 'HA SUB3'. Below these are four large 11-segment displays for PV, SV, and MV. At the bottom, there are three rows of indicators: 'OUT1 STOP' with a 'TIT' symbol, 'OUT2 CMW MANU', and four 4-segment displays.</p> <ul style="list-style-type: none"> • Number of displays: 3 (PV, SV, and MV) * • ALM indicator was changed to SUB indicator.
E5GN	 <p>The diagram shows the display panel for previous E5GN models. It features a top row with 'omron E5GN' on the left and 'CMW STOP OUT' on the right. Below this are four large 7-segment displays for PV and SV, followed by four smaller 7-segment displays. At the bottom are four navigation buttons: a square, a circular arrow, a downward arrow, and an upward arrow.</p> <ul style="list-style-type: none"> • Display Segments PV: 7 segments, SV: 7 segments • Character Heights PV: 7 mm, SV: 3.5 mm 	 <p>The diagram shows the display panel for upgraded E5GN models. It features a top row with 'omron E5GN' on the left and 'CMW STOP OUT' on the right. Below this are four large 11-segment displays for PV, SV, and MV, followed by four smaller 11-segment displays. At the bottom are four navigation buttons: a square, a circular arrow, a downward arrow, and an upward arrow. On the left side, there are indicators for 'SUB1', 'SUB2', and 'HA'.</p> <ul style="list-style-type: none"> • Display Segments PV: 11 segments, SV: 11 segments • Character Heights PV: 7.5 mm, SV: 3.6 mm • Changes to Display Contents "AL" LED indicator eliminated, LED indicators added, and key indicator added.

- * A 2-level display is set when shipped from the factory.
A 3-level display is activated if parameters are initialized.

■ Body Drawout

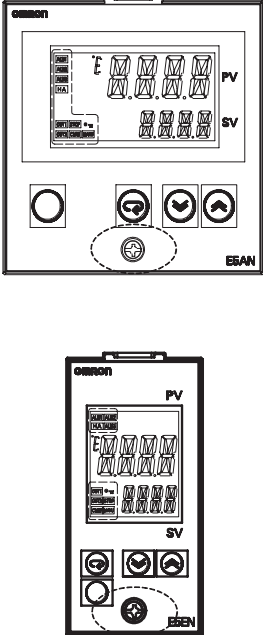
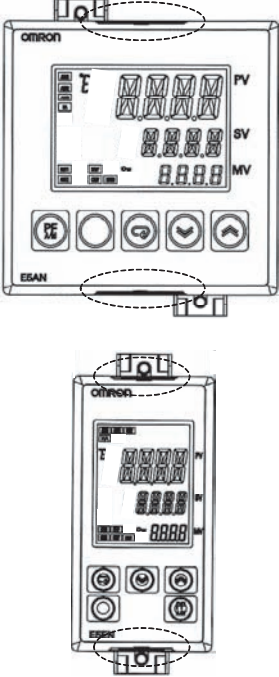
	Previous models	Upgraded models
E5AN/EN	<ul style="list-style-type: none"> Using Screws 	<ul style="list-style-type: none"> Using Hooks 

■ Dimensions

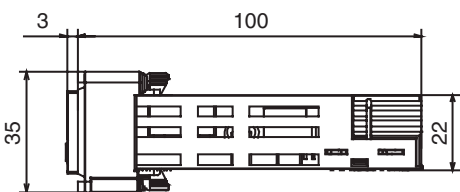
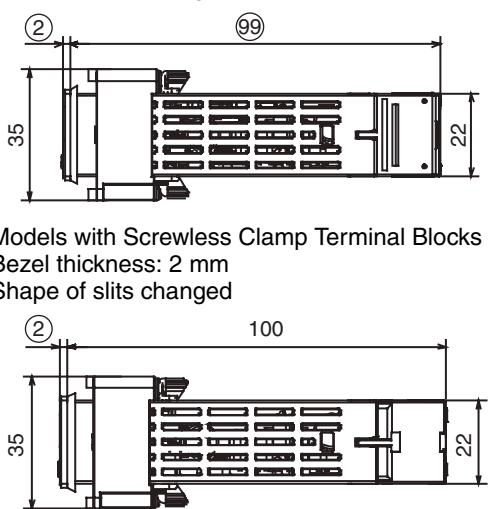
	Previous models	Upgraded models
E5GN	 <p>Bezel thickness: 3 mm Depth: 100 mm</p>	<ul style="list-style-type: none"> Models with Screw Terminal Blocks Bezel thickness: 2 mm Depth: 99 mm Shape of slits changed Models with Screwless Clamp Terminal Blocks Bezel thickness: 2 mm Shape of slits changed 

■ Terminal Block Configuration

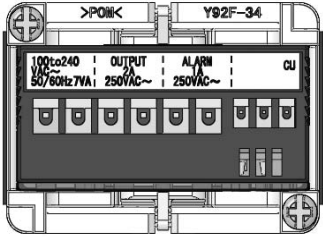
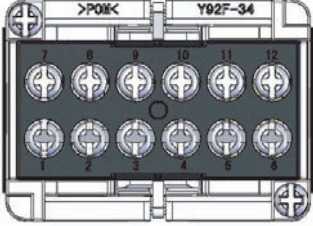
	Previous models	Upgraded models
E5GN	<ul style="list-style-type: none"> Models with Screw Terminal Blocks <ul style="list-style-type: none"> Terminals 1 to 6: M2.6 screw terminals Terminals 7 to 9: M2 screw terminals 	<ul style="list-style-type: none"> Models with Screw Terminal Blocks <ul style="list-style-type: none"> Terminals 1 to 12: M3 screw terminals Models with Screwless Clamp Terminal Blocks <ul style="list-style-type: none"> Terminals 1 to 12: None 

■ Wire Connections

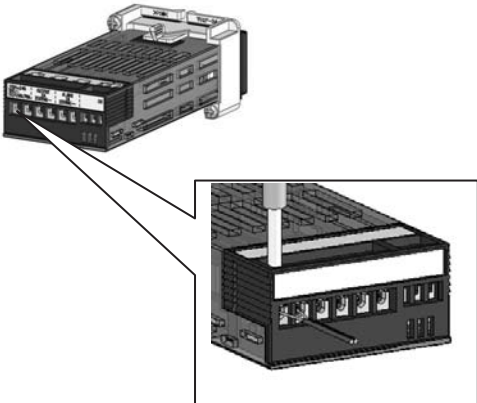
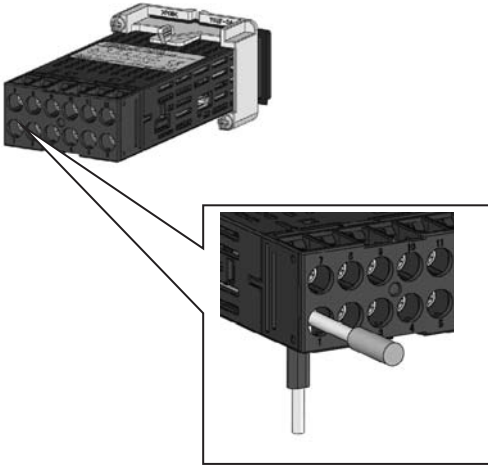
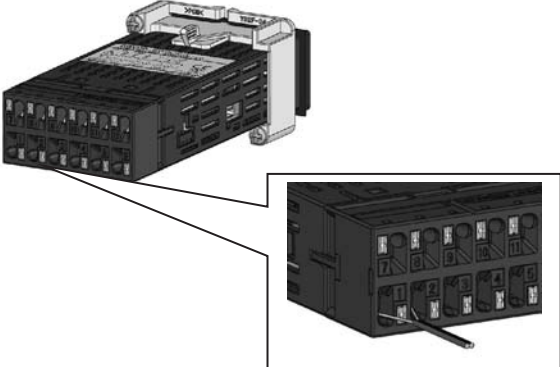
	Previous models	Upgraded models
E5GN	<ul style="list-style-type: none"> • Wire connection direction: Perpendicular to back surface 	<ul style="list-style-type: none"> • Models with Screw Terminal Blocks Wire connection direction: Horizontal from the top and bottom of back surface • Models with Screwless Clamp Terminal Blocks Wire connection direction: Perpendicular to back surface  

■ Wiring Terminals

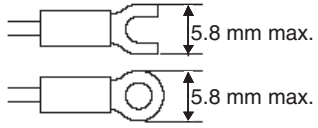
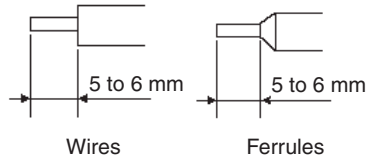
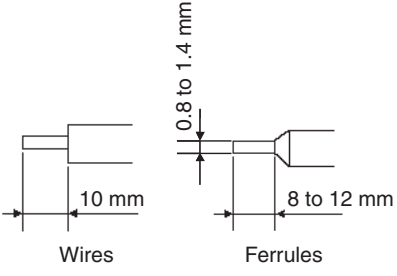
	Previous models	Upgraded models									
E5GN	<ul style="list-style-type: none"> Models with Screw Terminal Blocks 	<ul style="list-style-type: none"> Models with Screw Terminal Blocks Changed from ferrules to crimp terminals for M3 screws. Tightening torque: 0.5 N-m 									
	<table border="1"> <thead> <tr> <th>Terminals</th> <th>Wire gauge</th> <th>Ferrules</th> </tr> </thead> <tbody> <tr> <td>Terminals 1 to 6</td> <td>AWG24 to AWG14</td> <td>2.1 mm dia. max.</td> </tr> <tr> <td>Terminals 7 to 9</td> <td>AWG28 to AWG22</td> <td>1.3 mm dia. max.</td> </tr> </tbody> </table>	Terminals	Wire gauge	Ferrules	Terminals 1 to 6	AWG24 to AWG14	2.1 mm dia. max.	Terminals 7 to 9	AWG28 to AWG22	1.3 mm dia. max.	
	Terminals	Wire gauge	Ferrules								
	Terminals 1 to 6	AWG24 to AWG14	2.1 mm dia. max.								
Terminals 7 to 9	AWG28 to AWG22	1.3 mm dia. max.									
	<ul style="list-style-type: none"> Models with Screwless Clamp Terminal Blocks Wires: Changed to 10 mm from 5 to 6 mm. Ferrules: Changed to 8 to 12 mm from 5 to 6 mm. 										
<table border="1"> <thead> <tr> <th>Terminals</th> <th>Screws</th> <th>Tightening torque</th> </tr> </thead> <tbody> <tr> <td>Terminals 1 to 6</td> <td>M2.6</td> <td>0.23 to 0.25 N-m</td> </tr> <tr> <td>Terminals 7 to 9</td> <td>M2</td> <td>0.12 to 0.14 N-m</td> </tr> </tbody> </table>	Terminals	Screws	Tightening torque	Terminals 1 to 6	M2.6	0.23 to 0.25 N-m	Terminals 7 to 9	M2	0.12 to 0.14 N-m		
Terminals	Screws	Tightening torque									
Terminals 1 to 6	M2.6	0.23 to 0.25 N-m									
Terminals 7 to 9	M2	0.12 to 0.14 N-m									

■ Removing the Terminal Block

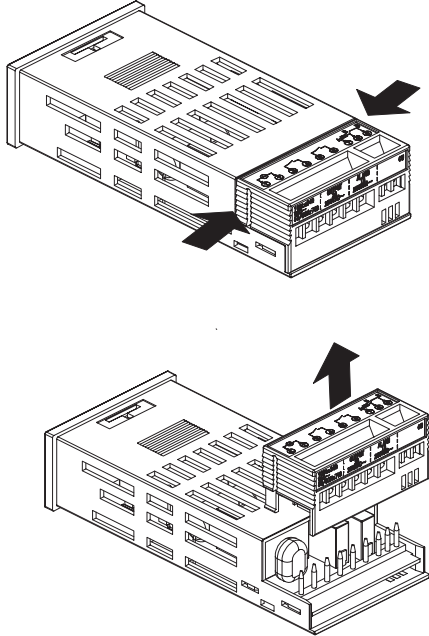
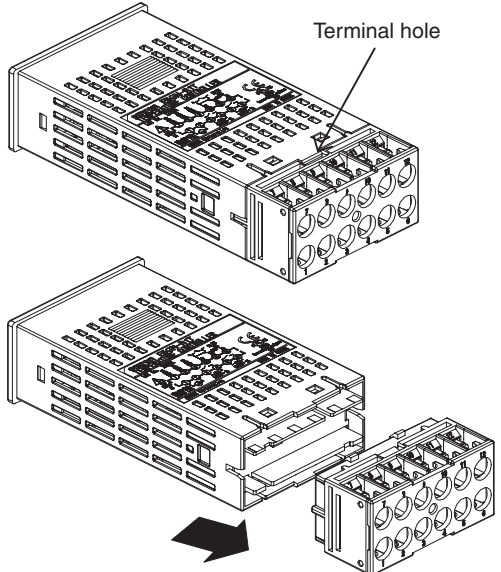
	Previous models	Upgraded models
E5GN	<p>Press firmly in on both sides of the terminal block to release the lock and then pull up on the terminal block.</p> 	<p>Insert a tool into the tool holes (one on the top and one on the bottom) to release the hooks and pull up the terminal block.</p>  <p>Note The method for removing the terminal block is the same for both screw terminal blocks and screwless clamp terminal blocks.</p>

■ Ratings

	Previous models	Upgraded models
Input sensor types for thermocouple inputs	---	The following types of thermocouple input were added: W and PLII.
	Input range for E thermocouple: 0 to 600°C	Input range increased for E thermocouple: -200 to 600°C
Input accuracy (There are no changes in thermocouple specifications for E5CN-U.)	<ul style="list-style-type: none"> • Thermocouple: ($\pm 0.5\%$ PV or $\pm 1^\circ\text{C}$, whichever is greater) ± 1 digit • Platinum resistance thermometer: ($\pm 0.5\%$ PV or $\pm 1^\circ\text{C}$, whichever is greater) ± 1 digit • Analog input: $\pm 0.5\%$ FS ± 1 digit 	<ul style="list-style-type: none"> • Thermocouple: ($\pm 0.3\%$ PV or $\pm 1^\circ\text{C}$, whichever is greater) ± 1 digit • Platinum resistance thermometer: ($\pm 0.2\%$ PV or $\pm 0.8^\circ\text{C}$, whichever is greater) ± 1 digit • Analog input: $\pm 0.2\%$ FS ± 1 digit
Influence of signal source resistance	<ul style="list-style-type: none"> • Thermocouple: $0.1^\circ\text{C}/\Omega$ (except B, R, S), $0.2^\circ\text{C}/\Omega$ (B, R, S) • Platinum resistance thermometer: $0.4^\circ\text{C}/\Omega$ 	<ul style="list-style-type: none"> • Thermocouple: $0.1^\circ\text{C}/\Omega$ (for all specifications) • Platinum resistance thermometer: $0.1^\circ\text{C}/\Omega$
Current outputs	Current output resolution: Approx. 2,700	Current output resolution: Approx. 10,000
Auxiliary outputs (alarm outputs)	E5CN/E5CN-U/E5GN 250 VAC, 1 A	E5CN/E5CN-U E5GN 250 VAC, 3 A 250 VAC, 2 A
Input sampling cycle	E5GN 500 ms	E5GN 250 ms

■ Characteristics

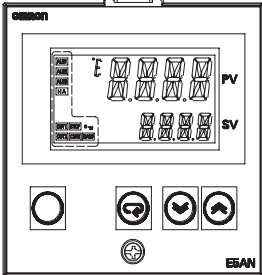
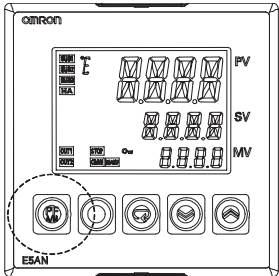
	Previous models	Upgraded models
Model numbers for the E5CN	Models with 24-VAC/VDC power supply specifications Example: E5CN-R2MT-500 (24 VAC/VDC)	A "D" was added to the model numbers for models with 24-VAC/VDC power supply specifications. Example: E5CN-R2MTD-500 (24 VAC/VDC)
Model numbers for the E5AN/EN	Example: E5AN-R3MT-500 (100 to 240 VAC) Example: E5AN-R3MT-500 (24 VAC/VDC)	"-N" was added to all model numbers A "D" was added to the model numbers for models with 24-VAC/VDC power supply specifications. Example: <ul style="list-style-type: none"> • E5AN-R3MT-500-N (100 to 240 VAC) • E5AN-R3MTD-500-N (24 VAC/VDC)
Model numbers for the E5GN	Examples: E5GN-RTC (100 to 240 VAC) E5GN-RP (100 to 240 VAC) 24-VAC/DC Specification Example: E5GN-RTC (24 VAC/DC)	<ul style="list-style-type: none"> • Model numbers have changed accompanying the introduction of universal input capability. • A "D" was added to the model numbers for models with 24-VAC/VDC power supply specifications. Example: E5GN-RT (100 to 240 VAC) E5GN-RTD (24 VAC/VDC)
Front panel	---	PV status display and SV status display
		PF Key added (E5AN/EN only). 
	---	PV/SP display selection for three-level display (E5AN/EN only) *

	Previous models	Upgraded models
Inputs	---	Square root extraction (for models with analog inputs)
Outputs	---	Control output ON/OFF count alarm
	---	MV change rate limiter
Controls	---	40% AT
	---	Automatic cooling coefficient adjustment for heating/cooling control
Alarms	---	PV rate of change alarm
	---	OC alarm (only for models with heater burn-out detection)
Other	---	Logic operations
	---	Inverting direct/reverse operation using event inputs or communications commands





- * A 2-level display is set when shipped from the factory.
A 3-level display is activated if parameters are initialized.

■ Communications Characteristics

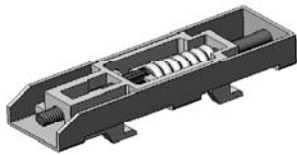
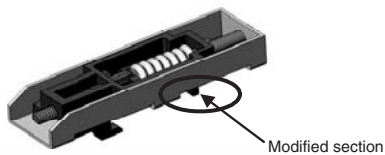
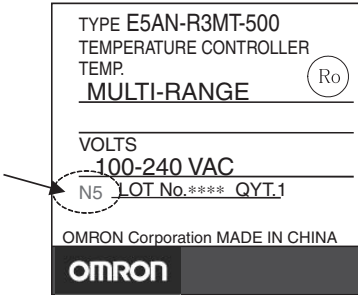
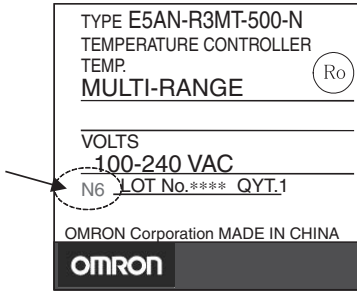
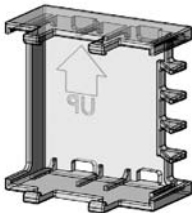
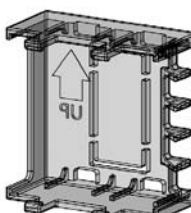
	Previous models	Upgraded models
Communications access size	Double word access only	Word access and double word access
CompoWay/F services	---	Composite Read from Variable Area and Composite Write to Variable Area
Communications buffer size	40 bytes	217 bytes
Baud rate	38.4 kbps max. E5GN: 19.2k max.	57.6 kbps max. Setup Tool Cable Communications: 38.4k (fixed)
External communications	RS-485/RS-232C external communications and Setup Tool communications cannot be used at the same time.	RS-485/RS-232C external communications and Setup Tool communications can be used at the same time.

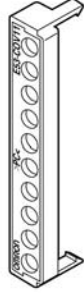
■ Other Upgrades

	Previous models	Upgraded models
Mounting Bracket (E5AN/EN only)	 <p>Mounting Bracket for previous models</p>	 <p>Mounting Bracket for upgraded models</p> <p>Note The Mounting Bracket for the previous models cannot be used for upgraded models.</p>
Packing case (E5AN/EN only)	<ul style="list-style-type: none"> • Previous ID code: N5 	<ul style="list-style-type: none"> • New ID code: N6 
Terminal Cover (sold separately) for E5CN	<ul style="list-style-type: none"> • E53-COV10 (for E5CN only) 	<ul style="list-style-type: none"> • E53-COV17 (for E5CN only) <p>Note The Terminal Cover for the previous models cannot be used for improved models.</p> 

	Previous models	Upgraded models
Terminal Cover (sold separately) for E5AN/EN	<ul style="list-style-type: none"> E53-COV11 	<ul style="list-style-type: none"> E53-COV16 <p>Note The Terminal Cover for the previous models cannot be used for improved models.</p> 
Front Panel Labels (E5GN)	 <ul style="list-style-type: none"> Display area dimensions: 36.1 × 9.8 mm (W × H) 	 <ul style="list-style-type: none"> The design has been changed. Added characters: MANU, SUB1, SUB2, and HA Display area dimensions: 36.8 × 10.1 mm (W × H)

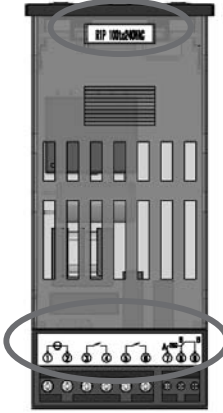
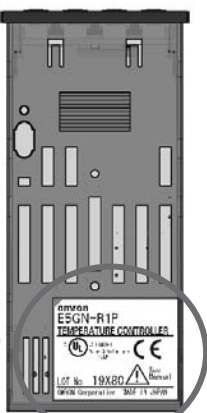
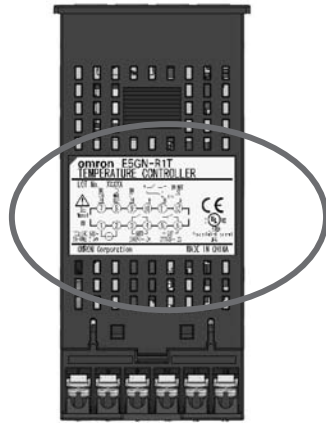
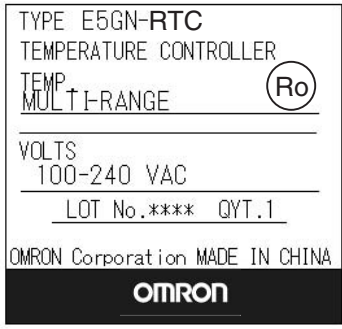
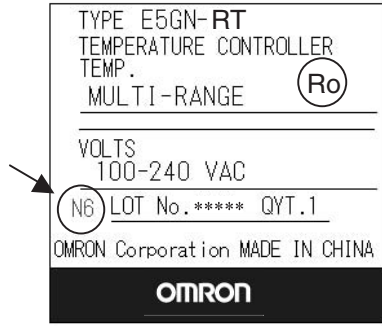
	Previous models	Upgraded models
Body Labels (E5GN)	<p>1. Body labels: 3</p> <p>2. Model number: Refer to the model number legend.</p> <p>3. Lot No.: <u>Year of manufacture (last digit of year)</u></p> <p>□□□□□□ ①②③④⑤⑥</p> <p>1, 2: Manufacture day: 01 to 31</p> <p>3: Manufacture month: 1 to 9, X, Y, and Z (January to December)</p> <p>4: Last digit of year.</p> <p>5, 6: Manufacturing factory code</p> <div style="display: flex; justify-content: space-around; align-items: center;">   </div> <p style="text-align: center;">Top of Controller Bottom of Controller</p>	<p>1. Body labels: All labels combined into one label.</p> <p>2. Model number: Refer to the model number legend.</p> <p>3. Lot No.: <u>Year of manufacture (last two digits of year)</u></p> <p>□□□□□□□ ①②③④⑤⑥⑦</p> <p>1, 2: Manufacture day: 01 to 31</p> <p>3: Manufacture month: 1 to 9, X, Y, and Z (January to December)</p> <p>4, 5: Year of manufacture (last two digits of year)</p> <p>6, 7: Manufacturing factory code</p> <div style="text-align: center;">  </div> <p style="text-align: center;">Top of Controller</p>
Box Labels (E5GN)	<p>No ID number</p> <div style="text-align: center;">  </div>	<p>"N6" has been added to identify the new models.</p> <div style="text-align: center;">  </div>

Conventions Used in This Manual

Model Notation

The E5CN-□□□, E5CN-□□□U, E5AN-□□□, E5EN-□□□, and E5GN-□□□ are given as the E5CN, E5CN-U, E5AN, E5EN, and E5GN when they share functionality.

The following notation is used when specifying differences in functionality.

Notation	Options
E5□N-□□□B	Two event inputs
E5□N-□□□03	RS-485 communications
E5□N-□□H	One of HB, HS, and heater overcurrent detection
E5□N-□□HH	Two of HB, HS, and heater overcurrent detection (See note 1.)
E5□N-□□Q	Control output 2 (voltage output) (See note 1.)
E5□N-□□P	External power supply to ES1B (See note 1.)
E5□N-□□□01	RS-232C communications (See note 2.)
E5□N-□□F	Transfer output (See note 3.)

- Note:** (1) Excluding the E5GN.
 (2) Excluding the E5CN.
 (3) The E5AN and E5EN only.

Meanings of Abbreviations

The following abbreviations are used in parameter names, figures and in text explanations. These abbreviations mean the following:

Symbol	Term
PV	Process value
SP	Set point
SV	Set value
AT	Auto-tuning
ST	Self-tuning
HB	Heater burnout
HS	Heater short (See note 1.)
OC	Heater overcurrent
LBA	Loop burnout alarm
EU	Engineering unit (See note 2.)

- Note:** (1) A heater short indicates that the heater remains ON even when the control output from the Temperature Controller is OFF because the SSR has failed or for any other reason.
- (2) “EU” stands for Engineering Unit. EU is used as the minimum unit for engineering units such as °C, m, and g. The size of EU varies according to the input type.
 For example, when the input temperature setting range is –200 to +1300°C, 1 EU is 1°C, and when the input temperature setting range is –20.0 to +500.0°C, 1 EU is 0.1°C.
 For analog inputs, the size of EU varies according to the decimal point position of the scaling setting, and 1 EU becomes the minimum scaling unit.

How to Read Display Symbols

The following tables show the correspondence between the symbols displayed on the displays and alphabet characters. The default is for 11-segment displays.

A	b	C	d	E	F	G	H	I	J	K	L	M
A	B	C	D	E	F	G	H	I	J	K	L	M

N	ō	P	Q	R	S	T	U	V	W	X	Y	Z
N	O	P	Q	R	S	T	U	V	W	X	Y	Z

The Character Select parameter in the advanced function setting level can be turned OFF to display the following 7-segment characters. (Refer to page 243.)

A	b	C	d	E	F	G	H	I	J	K	L	M
A	B	C	D	E	F	G	H	I	J	K	L	M

n	ō	P	q	r	S	T	U	v	Y	ū	Y	Ξ
N	O	P	Q	R	S	T	U	V	W	X	Y	Z

TABLE OF CONTENTS

SECTION 1

Introduction	1
1-1 Names of Parts	2
1-2 I/O Configuration and Main Functions	6
1-3 Setting Level Configuration and Key Operations	15
1-4 Communications Function	18
1-5 Insulation Block Diagrams	20

SECTION 2

Preparations	21
2-1 Installation	22
2-2 Wiring Terminals	31
2-3 Using the Support Software Port	45

SECTION 3

Basic Operation	49
3-1 Initial Setting Examples	50
3-2 Setting the Input Type	52
3-3 Selecting the Temperature Unit	54
3-4 Selecting PID Control or ON/OFF Control	54
3-5 Setting Output Specifications	54
3-6 Setting the Set Point (SP)	59
3-7 Using ON/OFF Control	60
3-8 Determining PID Constants (AT, ST, Manual Setup)	62
3-9 Alarm Outputs	69
3-10 Using Heater Burnout, Heater Short, and Heater Overcurrent Alarms	73
3-11 Setting the No. 3 Display	84

SECTION 4

Applications Operations	87
4-1 Shifting Input Values	89
4-2 Alarm Hysteresis	93
4-3 Setting Scaling Upper and Lower Limits for Analog Inputs	94
4-4 Executing Heating/Cooling Control	95
4-5 Using Event Inputs	99
4-6 Setting the SP Upper and Lower Limit Values	104
4-7 Using the SP Ramp Function to Limit the SP Change Rate	106
4-8 Moving to the Advanced Function Setting Level	108
4-9 Using the Key Protect Level	110
4-10 PV Change Color	113
4-11 Alarm Delays	116
4-12 Loop Burnout Alarm	118
4-13 Performing Manual Control	122
4-14 Using the Transfer Output	126

TABLE OF CONTENTS

4-15	Using the Simple Program Function	129
4-16	Output Adjustment Functions	136
4-17	Using the Extraction of Square Root Parameter	137
4-18	Setting the Width of MV Variation	139
4-19	Setting the PF Key	141
4-20	Counting Control Output ON/OFF Operations	143
4-21	Displaying PV/SV Status	145
4-22	Logic Operations	147
 SECTION 5		
Parameters		157
5-1	Conventions Used in this Section	158
5-2	Protect Level	159
5-3	Operation Level	163
5-4	Adjustment Level	177
5-5	Monitor/Setting Item Level	196
5-6	Manual Control Level	197
5-7	Initial Setting Level	199
5-8	Advanced Function Setting Level	218
5-9	Communications Setting Level	255
 SECTION 6		
CALIBRATION		257
6-1	Parameter Structure	258
6-2	User Calibration	260
6-3	Thermocouple Calibration (Thermocouple/Resistance Thermometer Input)	260
6-4	Platinum Resistance Thermometer Calibration (Thermocouple/Resistance Thermometer Input)	264
6-5	Analog Input Calibration (Thermocouple/Resistance Thermometer Input)	265
6-6	Calibrating Analog Input (Analog Input)	267
6-7	Checking Indication Accuracy	270
 Appendix		275
 Index		309
 Revision History		317

About this Manual:

This manual describes the E5CN/CN-U/AN/EN Digital Temperature Controllers and includes the sections described below.

Please read this manual carefully and be sure you understand the information provided before attempting to set up or operate an E5CN/CN-U/AN/EN Digital Temperature Controller.

• Overview

Section 1 introduces the features, components, and main specifications of the E5CN/CN-U/AN/EN/GN Digital Temperature Controllers.

• Setup

Section 2 describes the work required to prepare the E5CN/CN-U/AN/EN/GN Digital Temperature Controllers for operation, including installation and wiring.

• Basic Operations

Section 3 describes the basic operation of the E5CN/CN-U/AN/EN/GN Digital Temperature Controllers, including key operations to set parameters and descriptions of display elements based on specific control examples.

Section 5 describes the individual parameters used to setup, control, and monitor operation.

• Operations for Applications

Section 4 describes scaling, the SP ramp function, and other special functions that can be used to make the most of the functionality of the E5CN/CN-U/AN/EN/GN Digital Temperature Controllers.

Section 5 describes the individual parameters used to setup, control, and monitor operation.

• User Calibration

Section 6 describes how the user can calibrate the E5CN/CN-U/AN/EN/GN Digital Temperature Controllers.

• Appendix

The **Appendix** provides information for easy reference, including lists of parameters and settings.



WARNING Failure to read and understand the information provided in this manual may result in personal injury or death, damage to the product, or product failure. Please read each section in its entirety and be sure you understand the information provided in the section and related sections before attempting any of the procedures or operations given.

SECTION 1

Introduction

This section introduces the features, components, and main specifications of the E5CN, and E5AN, and E5EN Digital Temperature Controllers.

1-1	Names of Parts	2
1-1-1	Front Panel	2
1-1-2	Explanation of Indicators	4
1-1-3	Using the Keys	5
1-2	I/O Configuration and Main Functions	6
1-2-1	I/O Configuration	6
1-2-2	Main Functions	12
1-3	Setting Level Configuration and Key Operations	15
1-3-1	Selecting Parameters	17
1-3-2	Saving Settings	18
1-4	Communications Function	18
1-5	Insulation Block Diagrams	20

1-1 Names of Parts

1-1-1 Front Panel

E5CN/CN-U

The front panel is the same for the E5CN and E5CN-U.

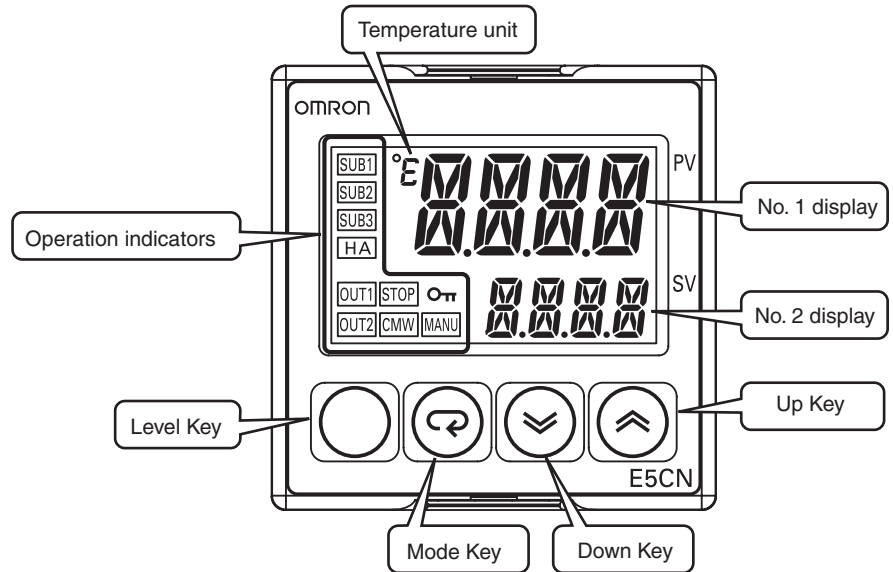

E5AN

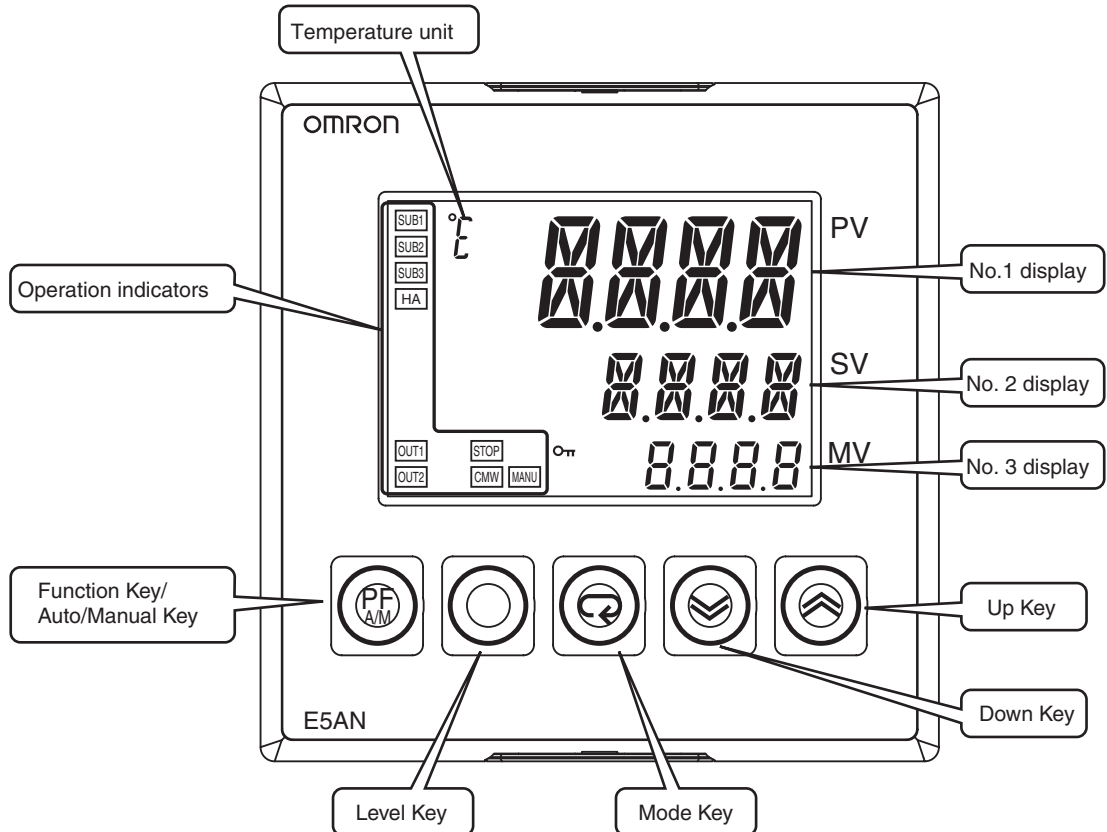

E5EN

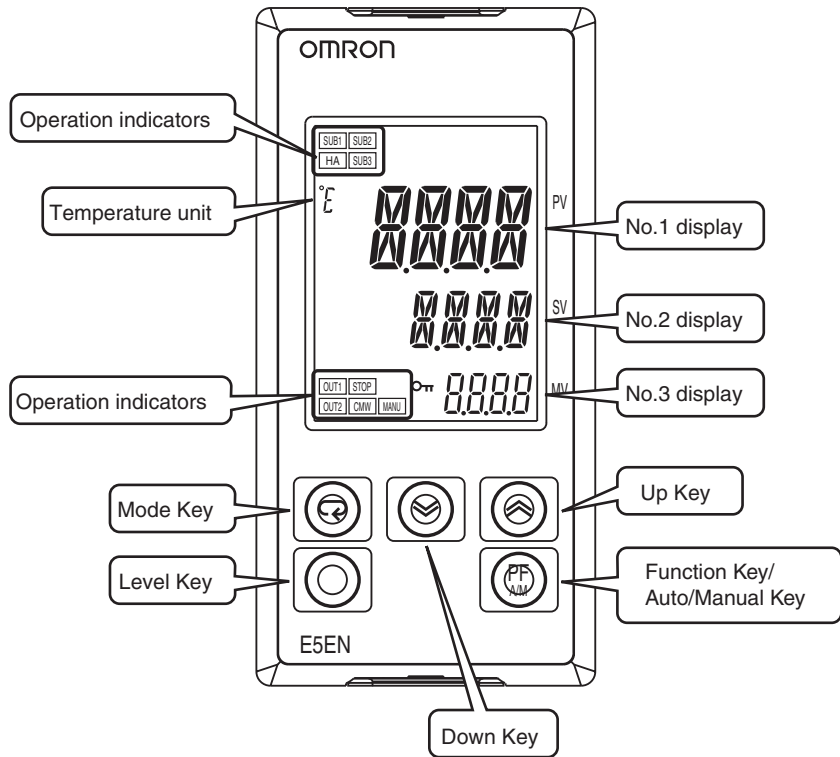

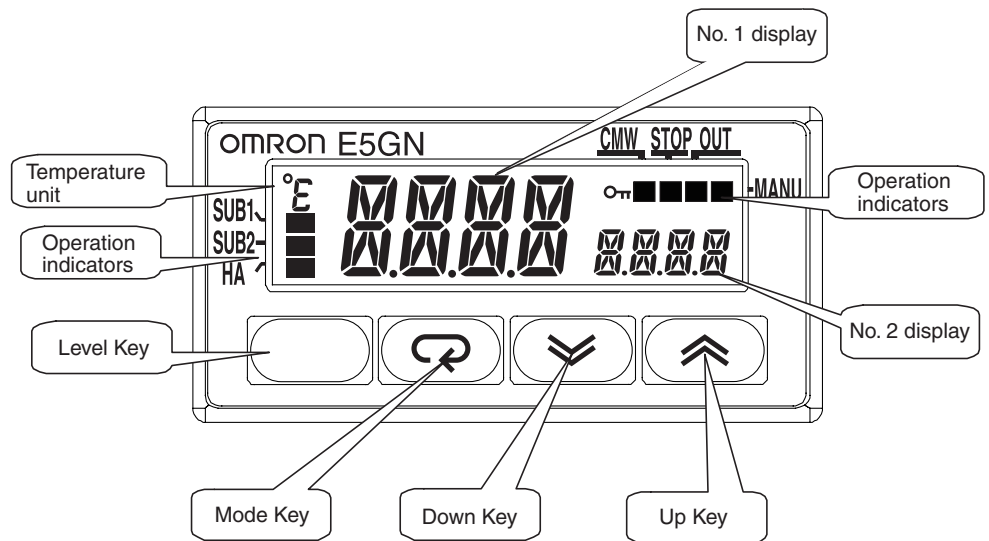

E5GN



1-1-2 Explanation of Indicators

No. 1 Display	Displays the process value or parameter name. Lights for approximately one second during startup.
No. 2 Display	Displays the set point, parameter operation read value, or the variable input value. Lights for approximately one second during startup. The set point will flash during autotuning.
No. 3 Display (E5AN/EN Only)	Displays MV, soak time remaining, or multi SP. Lights for approximately one second during startup. A 2-level display is set when shipped from the factory. A 3-level display is activated if parameters are initialized.

Operation Indicators

- 1,2,3...**
- SUB1 (Sub 1)**
Lights when the function set for the Auxiliary Output 1 Assignment parameter is ON.
 - SUB2 (Sub 2)**
Lights when the function set for the Auxiliary Output 2 Assignment parameter is ON.
 - SUB3 (Sub 3) (E5AN/EN Only)**
Lights when the function set for the Auxiliary Output 3 Assignment parameter is ON.
 - HA (Heater Burnout, Heater Short Alarm, Heater Overcurrent Detection Output Display)**
Lights when a heater burnout, heater short alarm, or heater overcurrent occurs.
 - OUT1 (Control Output 1)**
Lights when the control output function assigned to control output 1 turns ON. For a current output, however, OFF for a 0% output only.
 - OUT2 (Control Output 2) (Excluding the E5GN)**
Lights when the control output function assigned to control output 2 turns ON. For a current output, however, OFF for a 0% output only.
 - STOP**
Lights when operation is stopped.
During operation, this indicator lights when operation is stopped by an event or by key input using the RUN/STOP function.
 - CMW (Communications Writing)**
Lights when communications writing is enabled and is not lit when it is disabled.
 - MANU (Manual Mode)**
Lights when the auto/manual mode is set to manual mode.
 - On (Key)**
Lights when settings change protect is ON (i.e., when the  and  Keys are disabled by protected status.)

Temperature Unit

The temperature unit is displayed when parameters are set to display a temperature. The display is determined by the currently set value of the Temperature Unit parameter. °C indicates °C and °F indicates °F.
This indicator flashes during ST operation. It is OFF on models with linear inputs.

1-1-3 Using the Keys

This section describes the basic functions of the front panel keys.

PF (Function (Auto/Manual)) Key (E5AN/EN Only)

This is a function key. When it is pressed for at least 1 second, the function set in the PF Setting parameter will operate.

Example: When A-M (auto/manual) is selected in the PF Setting parameter (initial value: A-M), the key operates as an auto/manual switch, switching between Auto Mode and Manual Mode. If the key is pressed for more than 1 second (regardless of key release timing), the mode will switch.

Key

Press this key to move between setting levels. The setting level is selected in the following order: operation level: adjustment level, initial setting level, communications setting level.

Key

Press this key to change parameters within a setting level.

The parameters can be reversed by holding down the key (moving one per second in reverse order).

Key

Each press of this key increments the value displayed on the No. 2 display or advances the setting. Holding the key down speeds up the incrementation.



Key

Each press of this key decrements values displayed on the No. 2 display or reverses the setting. Holding the key down speeds up the incrementation.

+ Keys

Press these keys to change to the protect level. For details on operations involving holding these keys down simultaneously, refer to *1-3 Setting Level Configuration and Key Operations*. For details on the protect level, refer to *SECTION 5 Parameters*.

+ Keys + Keys

To restrict set value changes (in order to prevent accidental or incorrect operations), these key operations require simultaneously pressing the  key along with  or  key. This applies only to the parameter for the password to move to protect level. (Refer to page 162.)

1-2 I/O Configuration and Main Functions

1-2-1 I/O Configuration

E5CN

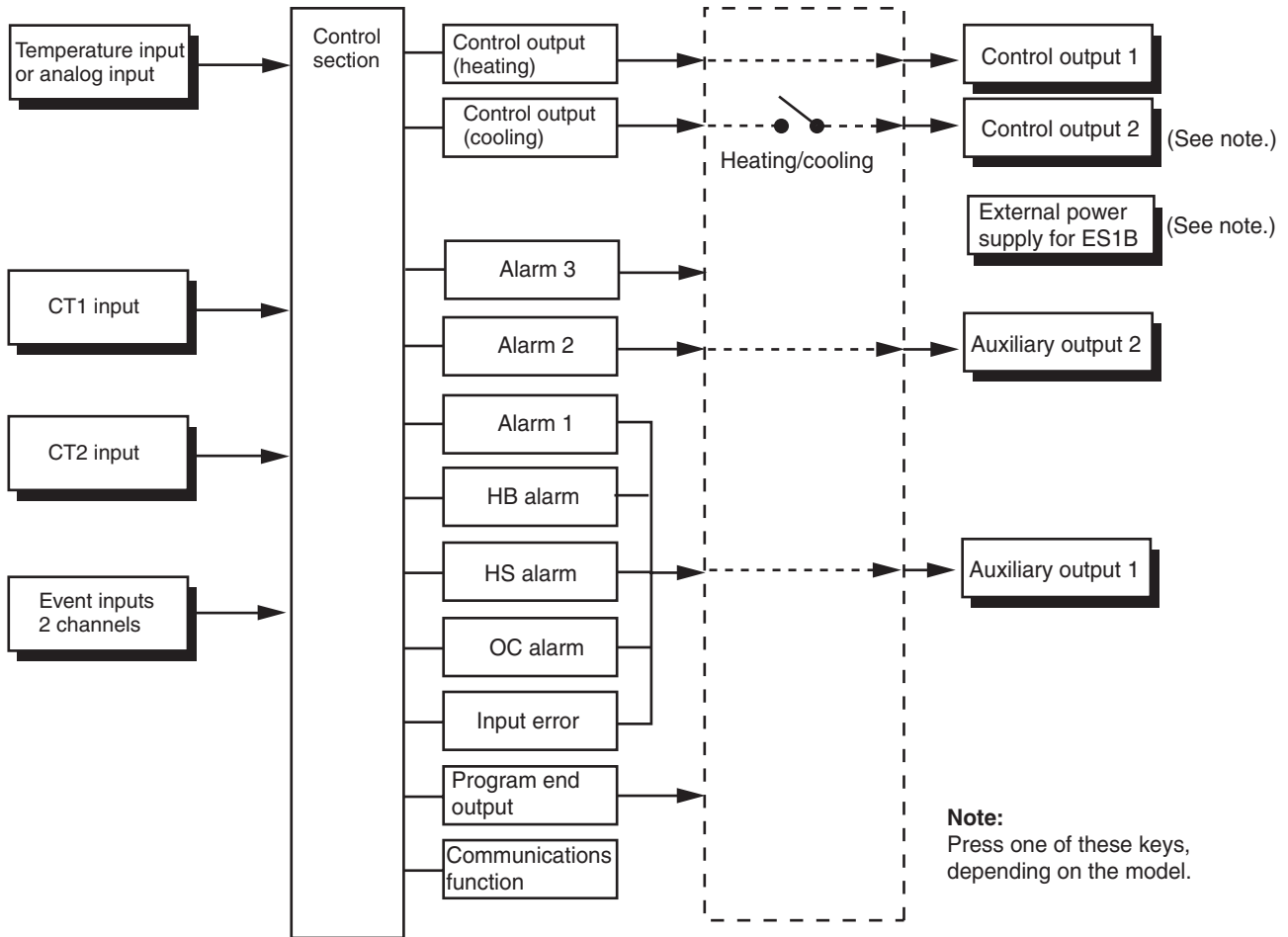

Note Functions can be assigned individually for each output by changing the set values for the Control Output 1 Assignment, the Control Output 2 Assignment, the Auxiliary Output 1 Assignment, and the Auxiliary Output 2 Assignment parameters in the advanced function setting level.

E5CN-U

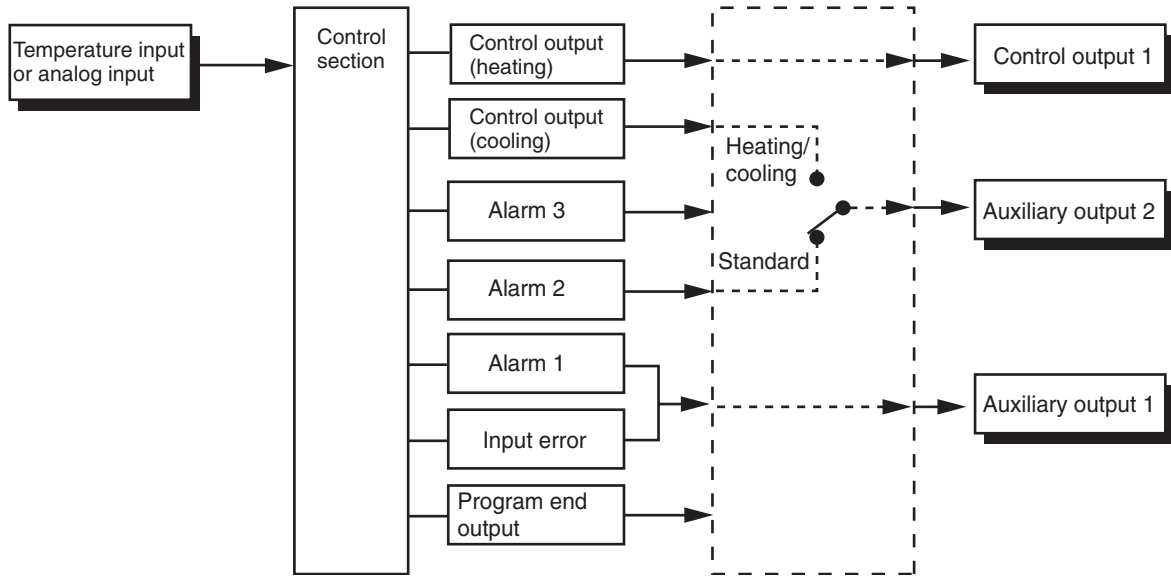

Note Functions can be assigned individually for each output by changing the set values for the Control Output 1 Assignment, the Auxiliary Output 1 Assignment, and the Auxiliary Output 2 Assignment parameters in the advanced function setting level.

Model Number Structure

Model Number Legend

Controllers

E5CN-□□M□□-□-500
 1 2 3 4 5 6 7

1. Control Output 1

R: Relay output
 Q: Voltage output (for driving SSR)
 C: Current output
 Y: Long-life relay output (hybrid) *1

2. Auxiliary Outputs *2

Blank: None
 2: Two outputs

3. Option

M: Option Unit can be mounted.

4. Input Type

T: Universal thermocouple/platinum
 resistance thermometer
 L: Analog current/voltage input

5. Power Supply Voltage

Blank: 100 to 240 VAC
 D: 24 VAC/VDC

6. Case Color

Blank: Black
 W: Silver

7. Terminal Cover

-500: With terminal cover

Option Units

E53-CN□□□□
 1 2 3 4

1. Applicable Controller

CN: E5CN or E5CN-H

2. Function 1

Blank: None
 Q: Control output 2 (voltage for driving SSR)

P: Power supply for sensor

3. Function 2

Blank: None

H: Heater burnout/SSR failure/Heater
 overcurrent detection (CT1)

HH: Heater burnout/SSR failure/
 Heater overcurrent detection
 (CT2)

B: Two event inputs

03: RS-485 communications

H03: Heater burnout/SSR failure/
 Heater overcurrent detection
 (CT1) + RS-485 communica-
 tions

HB: Heater burnout/SSR failure/
 Heater overcurrent detection
 (CT1) + Two event inputs

HH03: Heater burnout/SSR failure/
 Heater overcurrent detection
 (CT2) + RS-485 communications

4. Version

N2: Applicable only to models
 released after January 2008

E5CN-□□□□U
 1 2 3 4

1. Output Type

R: Relay output
 Q: Voltage output (for driving SSR)
 C: Current output

2. Number of Alarms

Blank: No alarm
 1: One alarm
 2: Two alarms

3. Input Type

T: Universal thermocouple/platinum
 resistance thermometer
 L: Analog Input

4. Plug-in type

U: Plug-in type

Note Not all combinations of function 1 and function 2 specifications are possible for Option Units (E53-□□□□).

*1 Always connect an AC load to a long-life relay output. The output will not turn OFF if a DC load is connected because a triac is used for switching the circuit. For details, check the conditions in *Ratings*.

*2 Auxiliary outputs are contact outputs that can be used to output alarms or results of logic operations.

E5AN/EN

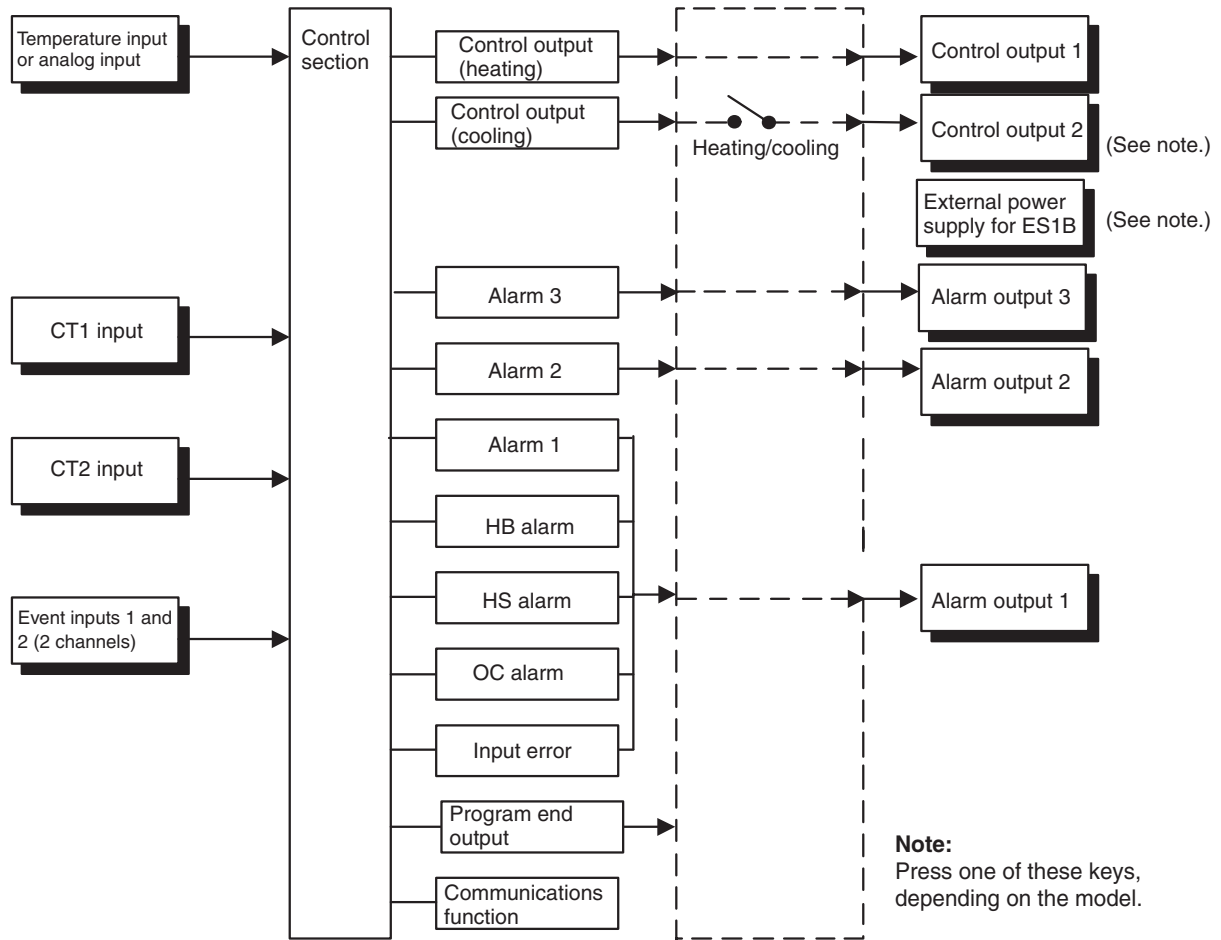

Note Functions can be assigned individually to each output by changing the set values for the Control Output 1 Assignment, Control Output 2 Assignment, Auxiliary Output 1 Assignment, Auxiliary Output 2 Assignment, and Auxiliary Output 3 Assignment parameters in the advanced function setting level.

Model Number Structure**Model Number Legends****Controllers**

E5AN/EN-□3□M□□-□-500-N
 1 2 3 4 5 6 7 8 9

1. Control Output 1

- R: Relay output
- Q: Voltage output (for driving SSR)
- C: Current output

2. Auxiliary Outputs

- 3: Three outputs

3. Heater Burnout/Heater Short, Control Output 2, or External Power Supply for ES1B

- Blank: None
- Q: Control output 2 (voltage output for driving SSR)
- Y: Long-life relay output (hybrid)
- H: Heater burnout/Heater short/Heater overcurrent detection (CT1)
- HH: Heater burnout/Heater short/Heater overcurrent detection (CT2)
- P: Power supply for sensor

4. Option

- M: Option Unit can be mounted.

5. Input Type

- T: Universal thermocouple/platinum resistance thermometer input
- L: Analog current/voltage input

6. Power Supply Voltage

- Blank: 100 to 240 VAC
- D: 24 VAC/VDC

7. Case Color

- Blank: Black
- W: Silver

8. Terminal Cover

- 500: With terminal cover

9. Version

- N: Available only to models released after January 2008.

Option Units

E53-□
 1

1. Function

- EN01: RS-232C communications
- EN03: RS-485 communications
- AKB: Event input

E5GN

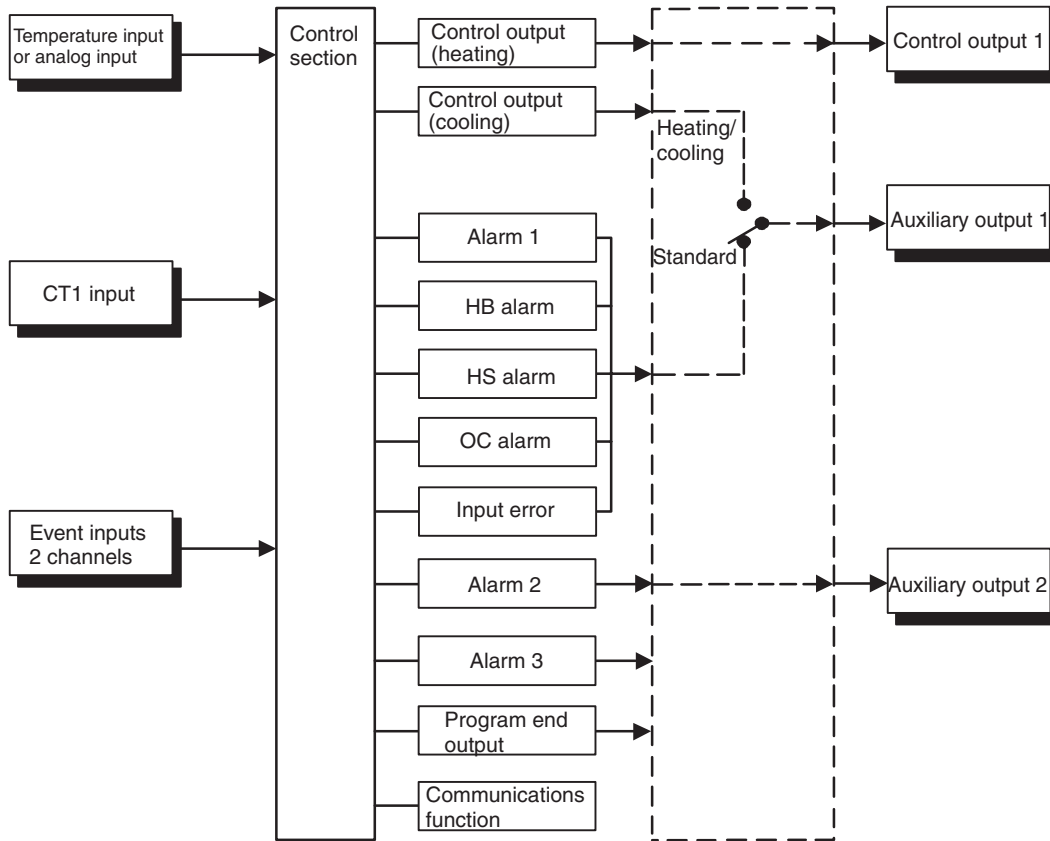

Note Functions can be assigned individually for each output by changing the set values for the Control Output 1 Assignment, the Auxiliary Output 1 Assignment, and the Auxiliary Output 2 Assignment parameters in the advanced function setting level.

Model Number Structure

Model Number Legends

Controllers

E5GN-□□□□□□-□-□-□
 1 2 3 4 5 6 7 8

1. Control Output 1

- R: Relay output
- Q: Voltage output (for driving SSR)
- C: Current output

2. Auxiliary Outputs

- Blank: None
- 1: One outputs
- 2: Two outputs

3. Option

- Blank: None
- 01: RS-232C communications
- 03: RS-485 communications
- B: Two event inputs
- H: Heater burnout/Heater short/Heater overcurrent detection (CT1)

4. Input Type

- T: Universal thermocouple/platinum resistance thermometer input
- L: Analog current/voltage input

5. Power Supply Voltage

- Blank: 100 to 240 VAC
- D: 24 VAC/VDC

6. Terminal Type

- Blank: Models with Screw Terminal Blocks
- C: Models with Screwless Clamp Terminal Blocks

7. Case Color

- Blank: Black
- W: Silver

8. Communications Protocol

- Blank: None
- FLK: CompoWay/F communications

Note Silver is available by special order only.

1-2-2 Main Functions

This section introduces the main E5CN/CN-U/AN/EN/GN functions. For details on particular functions and how to use them, refer to *SECTION 3 Basic Operation* and following sections.

Input Sensor Types

- The following input sensors can be connected for temperature input (i.e., E5_N-□□□□T):

Thermocouple:	K, J, T, E, L, U, N, R, S, B, W, PLII
Infrared temperature sensor:	ES1B 10 to 70°C, 60 to 120°C, 115 to 165°C, 140 to 260°C
Platinum resistance thermometer:	Pt100, JPt100
Analog input:	0 to 50 mV

- Inputs with the following specifications can be connected for analog input (i.e., E5_N-□□□□L):
 Current input: 4 to 20 mA DC, 0 to 20 mA DC
 Voltage input: 1 to 5 VDC, 0 to 5 V DC, 0 to 10 V DC

Control Outputs

- A control output can be a relay, voltage (for driving SSR), or current output, depending on the model.
- Long-life relay outputs (see note) use semiconductors for switching when closing and opening the circuit, thereby reducing chattering and arcing and improving durability. However, if high levels of noise or surge are imposed between the output terminals, short-circuit faults may occasionally occur. If the output becomes permanently shorted, there is the danger of fire due to overheating of the heater. Design safety into the system, including measures to prevent excessive temperature rise and spreading of fire. Take countermeasures such as installing a surge absorber. As an additional safety measure, provide error detection in the control loop. (Use the Loop Burnout Alarm (LBA) and HS alarm that are provided for the E5□N.)

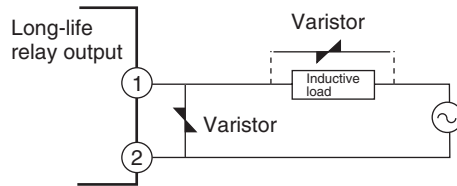

Select a surge absorber that satisfies the following conditions.

Voltage used	Varistor voltage	Surge resistance
100 to 120 VAC	240 to 270 V	1,000 A min.
200 to 240 VAC	440 to 470 V	

- Always connect an AC load to a long-life relay output (see note). The output will not turn OFF if a DC load is connected.

Note Long-life relay outputs are not supported for the E5GN.

Alarms

- Set the alarm type and alarm value or the alarm value upper and lower limits.
- If necessary, a more comprehensive alarm function can be achieved by setting a standby sequence, alarm hysteresis, auxiliary output close in alarm/open in alarm, alarm latch, alarm ON delay, and alarm OFF delay.
- If the Input Error Output parameter is set to ON, the output assigned to alarm 1 function will turn ON when an input error occurs.

Control Adjustment

- Optimum PID constants can be set easily by performing AT (auto-tuning) or ST (self-tuning).

Event Inputs

- With the E53-CN□B□N2 for the E5CN or the E5AN/EN-□M□-500-N with the E53-AKB for the E5AN/EN, the following functions can be executed using event inputs: switching set points (multi-SP, 4 points max.), switching RUN/STOP, switching between automatic and manual operation, starting/resetting the program, inverting direct/reverse operation, 100% AT execute/cancel, 40% AT execute/cancel, setting change enable/disable, and canceling the alarm latch.

Heater Burnout, HS Alarm, and Heater Overcurrent

- With the E53-CN□H□N2 or E53-CN□HH□N2 for the E5CN, or the E5AN/EN-□□H□-500-N or E5AN/EN-□□HH□-500-N, the heater burnout detection function, HS alarm function, and heater overcurrent detection function can be used.

Communications Functions

- Communications functions utilizing CompoWay/F (See note 1.), SYSWAY (See note 2.), or Modbus (See note 3.) can be used.

RS-485 Interface

Use the E53-CN□03N2 for the E5CN or the E53-EN03 for the E5AN/EN.

RS-232C Interface

Use the E53-EN01 for the E5AN/EN.

- Note**
- (1) CompoWay/F is an integrated general-purpose serial communications protocol developed by OMRON. It uses commands compliant with the well-established FINS, together with a consistent frame format on OMRON Programmable Controllers to facilitate communications between personal computers and components.
 - (2) SYSWAY communications do not support alarm 3.
 - (3) Modbus is a communications control method conforming to the RTU Mode of Modbus Protocol. Modbus is a registered trademark of Schneider Electric.
 - (4) The E5CN and E5CN-U do not support the RS-232C interface.

External Power Supply for ES1B

The E5AN-□P□-N or E5EN-□P□-N with the E53-CN□P□N2 can be used as the power supply for ES1B Infrared Temperature Sensors.

- Note** The E5GN does not provide a power supply for an ES1B Infrared Temperature Sensor.

Transfer Output

A transfer output for 4 to 20 mA can be used with the E5AN/E5EN-□□F.



For E5□N-C□□ models (models without “F” in the model number), the current output can be used as a simple transfer output.

Level	Control in progress	Control stopped
Advanced function setting level	---	Can be set.
Calibration level	---	Can be set.
Communications setting level	---	Can be set.

Of these levels, the initial setting level, communications setting level, advanced function setting level, and calibration level can be used only when control is stopped. Control outputs are stopped when any of these four levels is selected.

- (4) When the PF Setting is set to A-M in models with a PF Key (E5AN/EN)
- (5) When the PF Setting is set to PFDP in models with a PF Key (E5AN/EN)

Protect Level

- To switch to the protect level from the operation level, the adjustment level, or the monitor/setting item level, simultaneously hold down the  and  Keys for at least 3 seconds. (See note.) This level is for preventing unwanted or accidental modification of parameters. Protected levels will not be displayed, and so the parameters in that level cannot be modified.

Note The key pressing time can be changed in Move to Protect Level parameter (advanced function setting level).

Operation Level

- The operation level is displayed when the power is turned ON. You can move to the protect level, initial setting level, or adjustment level from this level.
- Normally, select this level during operation. While operation is in progress, items such as the PV and manipulated variable (MV) can be monitored, and the set points, alarm values, and alarm upper and lower limits can be monitored and changed.



Adjustment Level

- To move to the adjustment level, press the  Key once (for less than 1 s).
- This level is for entering set values and offset values for control. In addition to AT (auto-tuning), communications write enable/disable switching, hysteresis settings, multi-SP settings, and input offset parameters, it includes HB alarm, HS alarm, OC alarm, and PID constants. From the adjustment level, it is possible to move to the top parameter of the initial setting level, protect level, or operation level.



Monitor/Setting Item Level

- To switch to the monitor/setting item level, press the PF Key from the operation level or adjustment level. The contents set for monitor/setting items 1 to 5 can be displayed. You can move from the monitor/setting item level to the operation level or initial setting level. (This level is supported by the E5AN and E5EN only.)

Manual Control Level

- When the  Key is pressed for at least 3 seconds from the operation level's auto/manual switching display, the manual control level will be displayed. (The MANU indicator will light.)
- When the PF Setting is set to A-M (auto/manual) and the PF Key is pressed for more than one second from the operation level or adjustment level, the manual control level will be displayed (E5AN and E5EN only.)
- This is the level for changing the MV in manual mode.
- To return to the operation level, press the  Key for at least one second. It is also possible to return to the operation level by pressing the PF Key for more than one second when the PF Setting is set to A-M.

Initial Setting Level

- To move to the initial setting level from the operation level or the adjustment level, press the  Key for at least 3 seconds. The PV display flashes after one second. This level is for specifying the input type and selecting the control method, control period, setting direct/reverse operation, setting the alarm types, etc. You can move to the advanced function setting level or communications setting level from this level. To return to the operation level, press the  Key for at least one second. To move to the communications setting level, press the  Key for less than one second.

(When moving from the initial setting level to the operation level, all the indicators will light.)

Note Pressing the  Key for at least 3 seconds in the operation level's auto/manual switching display will move to the manual control level, and not the initial setting level.

Advanced Function Setting Level

- To move to the advanced function setting level, set the Initial Setting/Communications Protect parameter in the protect level to 0 and then, in the initial setting level, input the password (-169).
- From the advanced function setting level, it is possible to move to the calibration level or to the initial setting level.
- This level is for setting the automatic display return time and standby sequence, and it is the level for moving to the user calibration and other functions.

Communications Setting Level

- To move to the communications setting level from the initial setting level, press the  Key once (for less than 1 s). When using the communications function, set the communications conditions in this level. Communicating with a personal computer (host computer) allows set points to be read and written, and manipulated variables (MV) to be monitored.

Calibration Level

- To move to the calibration level, input the password (1201) from the advanced function setting level. The calibration level is for offsetting error in the input circuit.
- You cannot move to other levels from the calibration level by operating the keys on the front panel. To cancel this level, turn the power OFF then back ON again.

1-3-1 Selecting Parameters

- Within each level, the parameter is changed in order (or in reverse order) each time the  Key is pressed. (In the calibration level, however, parameters cannot be changed in reverse order.) For details, refer to *SECTION 5 Parameters*.

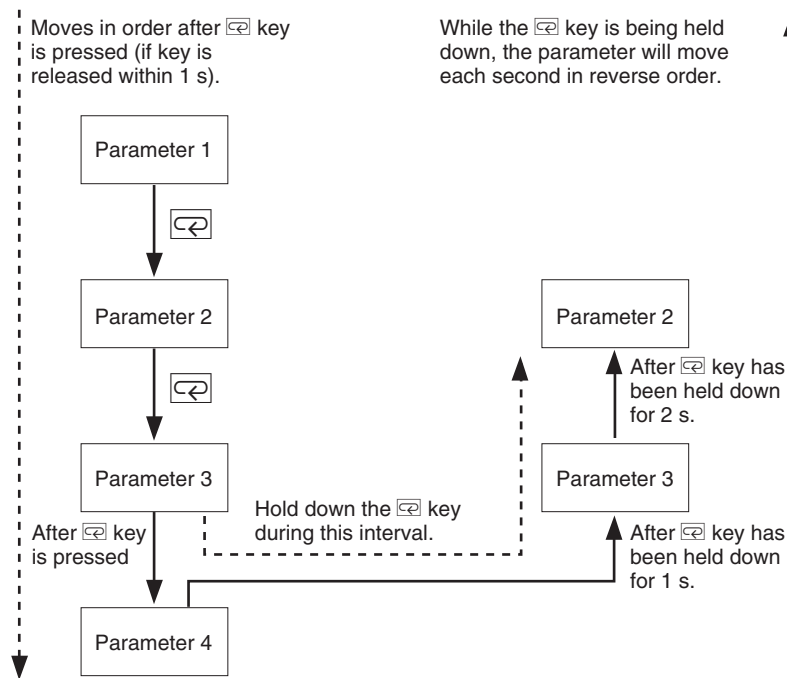

1-3-2 Saving Settings

- If you press the Key at the final parameter, the display returns to the top parameter for the current level.
- To change parameter settings, specify the setting using the or Key, and either leave the setting for at least two seconds or press the Key. This saves the setting.
- When another level is selected after a setting has been changed, the contents of the parameter prior to the change is saved.
- When you turn the power OFF, you must first save the settings (by pressing the Key). The settings are sometimes not changed by merely pressing the or Keys.

1-4 Communications Function

The E5CN/AN/EN/GN are provided with a communications function that enables parameters to be checked and set from a host computer. If the communications parameters function is required, use the E53-CN□03N2 with the E5CN, or the E53-EN03 or E53-EN01 with the E5AN/EN/GN. For details on the communications function, see the separate *Communications Manual Basic Type*. Use the following procedure to move to the communications setting level.

- 1,2,3...**
1. Press the Key for at least three seconds to move from the operation level to the initial setting level.
 2. Press the Key for less than one second to move from the initial setting level to the communications setting level.
 3. Select the parameters as shown below by pressing the Key.
 4. Press the or Key to change the parameter setting.

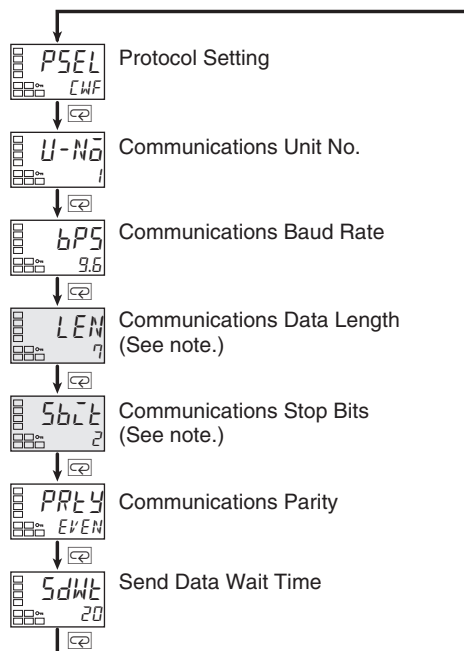

Note The Protocol Setting parameter is displayed only when CompoWay/F communications are being used.

Setting Communications Data

Match the communications specifications of the E5CN/AN/EN/GN and the host computer. If a 1:N connection is being used, ensure that the communications specifications for all devices in the system (except the communications Unit No.) are the same.

Parameter name	Symbol	Setting (monitor) value	Selection symbols	Default	Unit
Protocol Setting	<i>PSEL</i>	CompoWay/F (SYSWAY), Modbus	<i>WF, Mod</i>	CompoWay/F (SYSWAY)	None
Communications Unit No.	<i>U-No</i>	0 to 99		1	None
Communications Baud Rate	<i>bPS</i>	1.2, 2.4, 4.8, 9.6, 19.2, 38.4, 57.6	<i>1.2, 2.4, 4.8, 9.6, 19.2, 38.4, 57.6</i>	9.6	kbps
Communications Data Length	<i>LEN</i>	7, 8		7	Bits
Communications Stop Bits	<i>SbLt</i>	1, 2		2	Bits
Communications Parity	<i>PRLY</i>	None, Even, Odd	<i>NONE, EVEN, odd</i>	Even	None
Send Data Wait Time	<i>SdWE</i>	0 to 99		20	ms

1-5 Insulation Block Diagrams

The insulation block diagrams for the E5CN, E5AN, E5EN, and E5GN are provided in this section.

E5CN

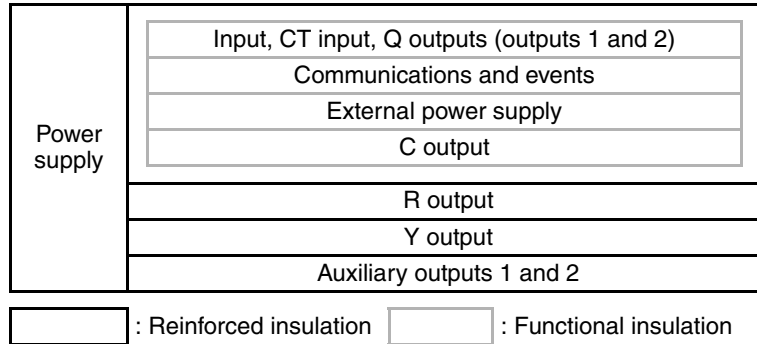

E5CN-U

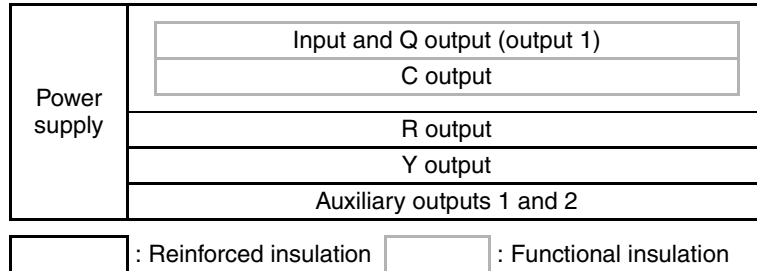

E5AN/EN

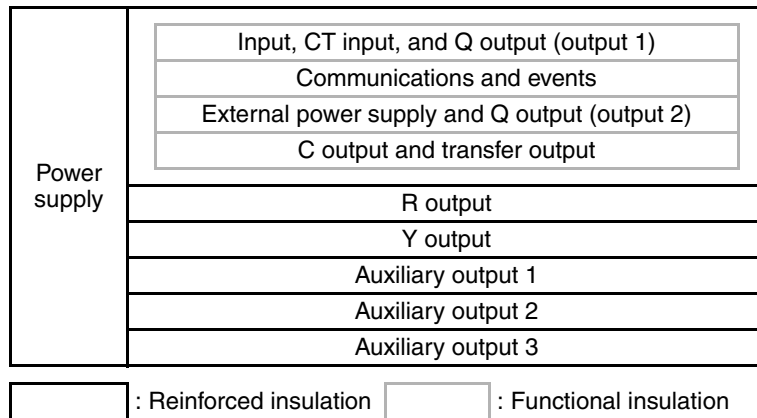

E5GN

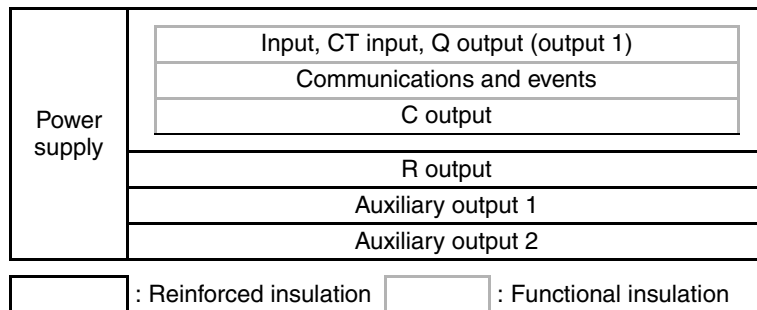

SECTION 2

Preparations

This section describes the work required to prepare the E5CN, E5AN, and E5EN Digital Temperature Controllers for operation, including installation and wiring.

2-1	Installation	22
2-1-1	Dimensions	22
2-1-2	Panel Cutout	24
2-1-3	Mounting.	25
2-1-4	Removing the Temperature Controller from the Case	28
2-2	Wiring Terminals.	31
2-2-1	Terminal Arrangement	31
2-2-2	Precautions when Wiring	33
2-2-3	Wiring	35
2-3	Using the Support Software Port.	45

2-1 Installation

2-1-1 Dimensions

Unit: mm

E5CN

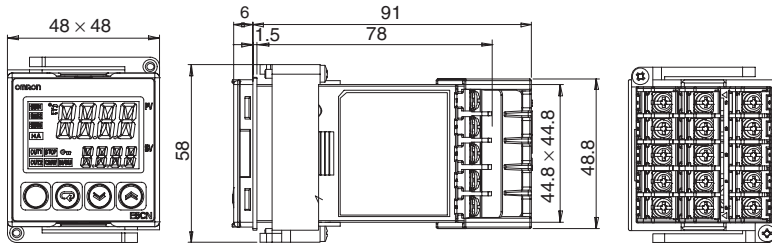

E5CN-U

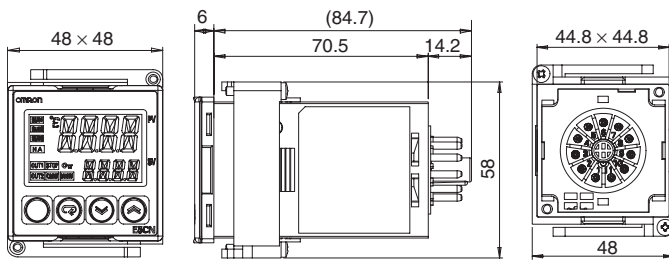

E5AN

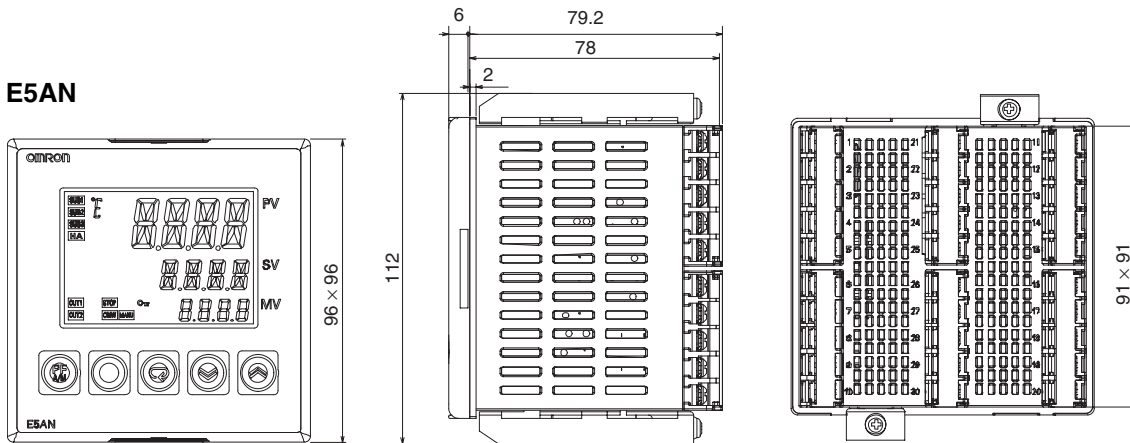

E5EN

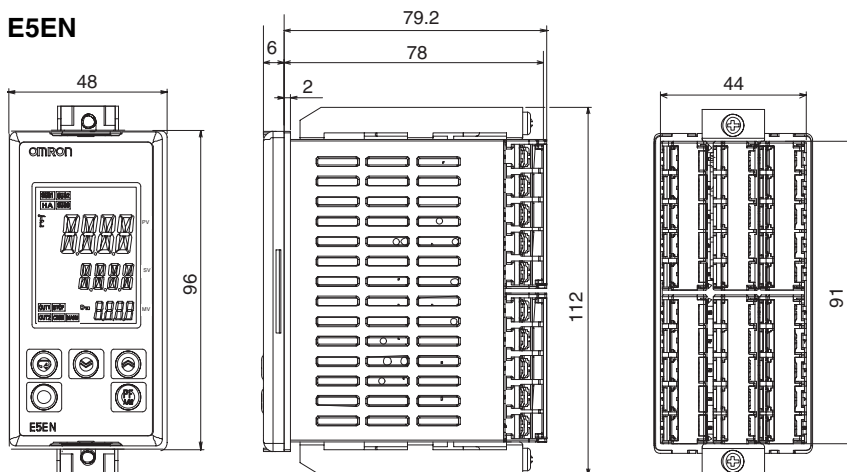

E5GN

- Models with Screw Terminal Blocks

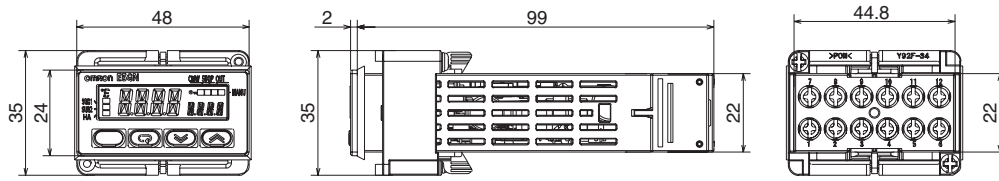

- Models with Screwless Clamp Terminal Blocks

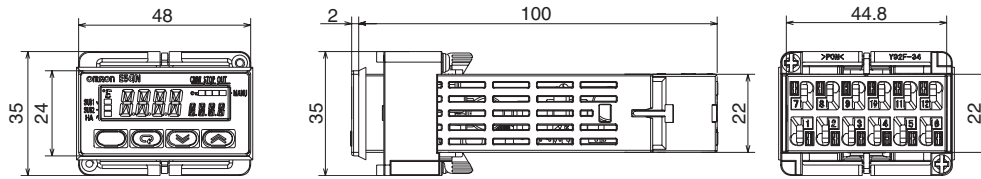

2-1-2 Panel Cutout

Unit: mm

E5CN/CN-U

Individual Mounting

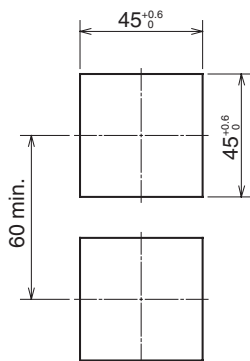

Group Mounting

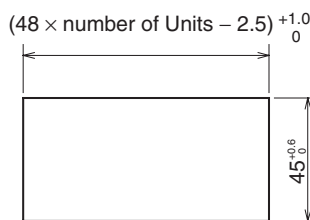

E5AN

Individual Mounting

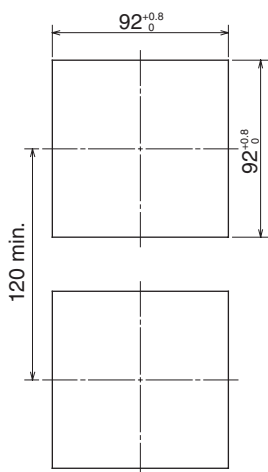

Group Mounting

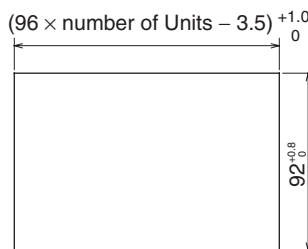

E5EN

Individual Mounting

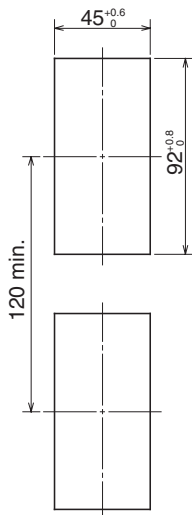

Group Mounting

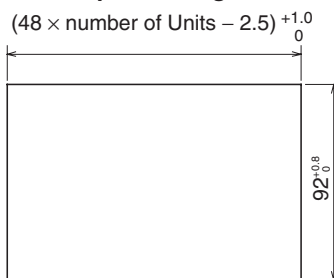

E5GN

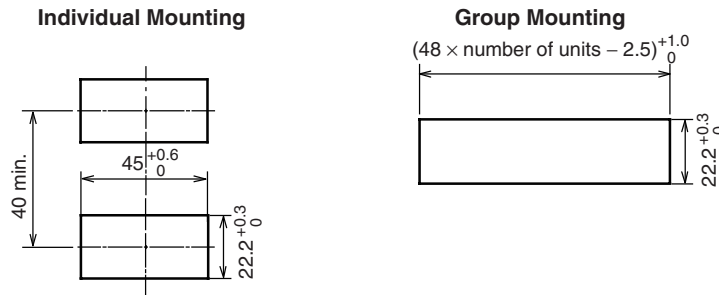

- Waterproofing is not possible when group mounting several Controllers.
- The recommended panel thickness is 1 to 5 mm for the E5CN, E5CN-U, and E5GN, and 1 to 8 mm for E5AN and E5EN.
- Units must not be closely mounted vertically. (Observe the recommended mounting space limits.)
- When group mounting several Controllers, ensure that the surrounding temperature does not exceed the ambient operating temperature listed in the specifications.

2-1-3 Mounting

E5CN/CN-U

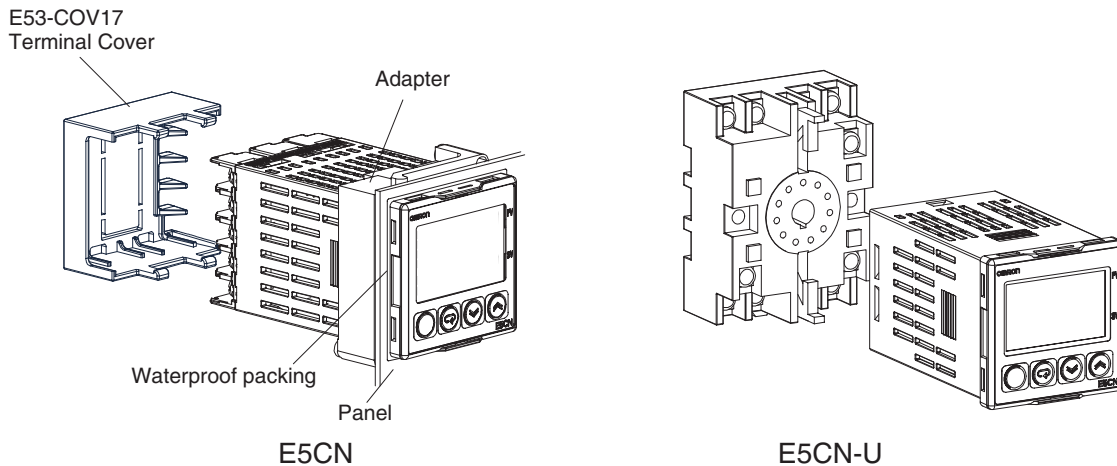

For the Wiring Socket for the E5CN-U, order the P2CF-11 or P3GA-11 separately.

Mounting to the Panel

- 1,2,3...**
1. For waterproof mounting, waterproof packing must be installed on the Controller. Waterproofing is not possible when group mounting several Controllers. Waterproof packing is not necessary when there is no need for the waterproofing function. There is no waterproof packing included with the E5CN-U.
 2. Insert the E5CN/E5CN-U into the mounting hole in the panel.
 3. Push the adapter from the terminals up to the panel, and temporarily fasten the E5CN/E5CN-U.
 4. Tighten the two fastening screws on the adapter. Alternately tighten the two screws little by little to maintain a balance. Tighten the screws to a torque of 0.29 to 0.39 N·m.

Mounting the Terminal Cover

For the E5CN, make sure that the “UP” mark is facing up, and then attach the E53-COV17 Terminal Cover to the holes on the top and bottom of the Temperature Controller.

E5AN/EN

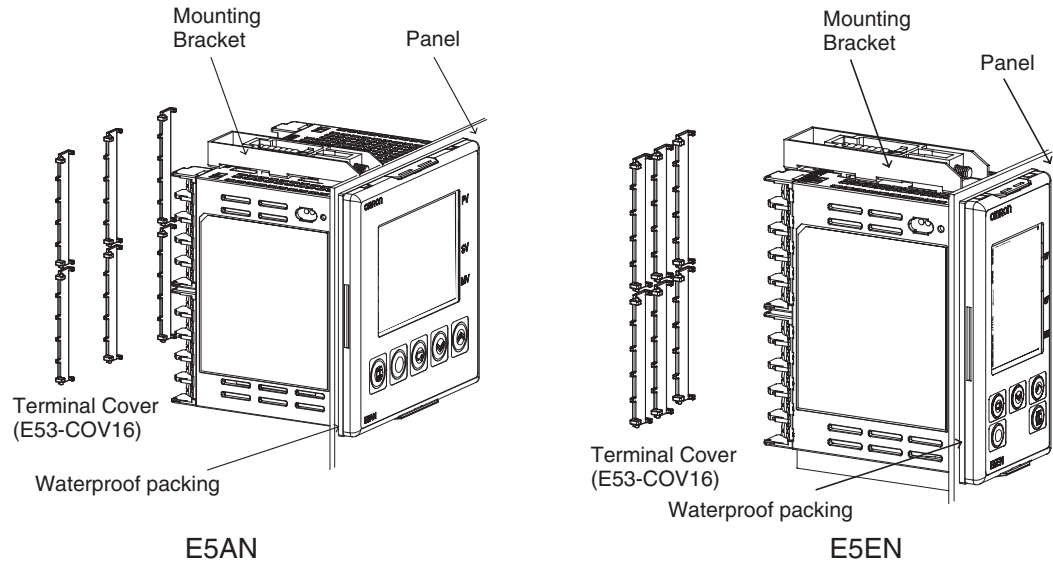

Mounting to the Panel

- 1,2,3...**
1. For waterproof mounting, waterproof packing must be installed on the Controller. Waterproofing is not possible when group mounting several Controllers. Waterproof packing is not necessary when there is no need for the waterproofing function.
 2. Insert the E5AN/E5EN into the square mounting hole in the panel (thickness: 1 to 8 mm). Attach the Mounting Brackets provided with the product to the mounting grooves on the top and bottom surfaces of the rear case.
 3. Use a ratchet to alternately tighten the screws on the top and bottom Mounting Brackets little by little to maintain balance, until the ratchet turns freely.

Mounting the Terminal Cover

Slightly bend the E53-COV16 Terminal Cover to attach it to the terminal block as shown in the following diagram. The Terminal Cover cannot be attached in the opposite direction.

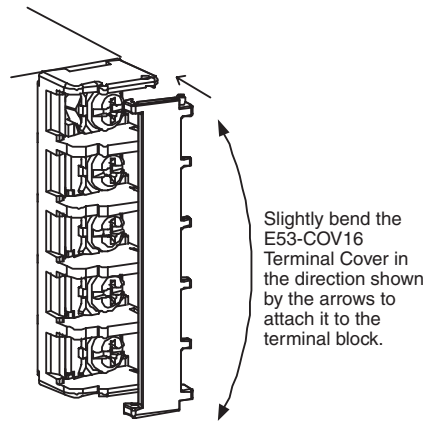

Enlarged Illustration of Terminal Section

E5GN

Mounting to the Panel

1,2,3...

1. For waterproof mounting, waterproof packing must be installed on the Controller. Waterproofing is not possible when group mounting several Controllers.
Waterproof packing is not necessary when there is no need for the waterproofing function.
2. Insert the E5GN into the mounting hole in the panel.
3. Push the adapter from the terminals up to the panel, and temporarily fasten the E5GN.
4. Tighten the two fastening screws on the adapter. Alternately tighten the two screws little by little to maintain a balance. Tighten the screws to a torque of 0.29 to 0.39 N·m.

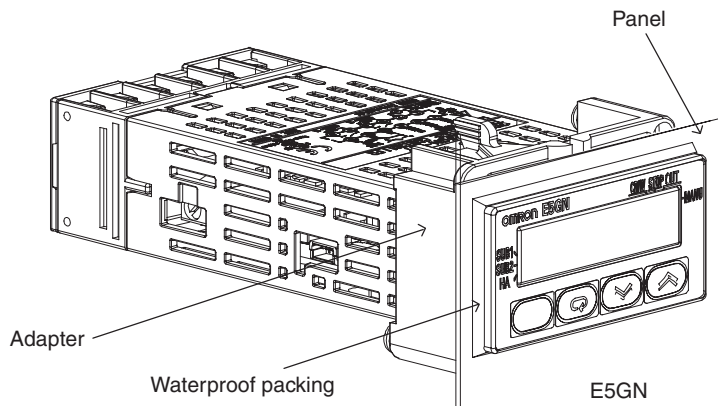

2-1-4 Removing the Temperature Controller from the Case

The Temperature Controller can be removed from the case to perform maintenance without removing the terminal leads. This is possible for only the E5CN, E5AN, and E5EN, and not for the E5CN-U or E5GN. Check the specifications of the case and Temperature Controller before removing the Temperature Controller from the case.

E5CN

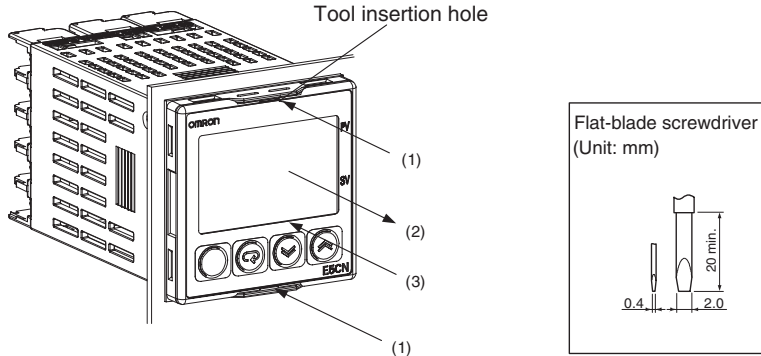

- 1,2,3...**
1. Insert a flat-blade screwdriver into the two tool insertion holes (one on the top and one on the bottom) to release the hooks.
 2. Insert the flat-blade screwdriver in the gap between the front panel and rear case, and pull out the front panel slightly. Hold the top and bottom of the front panel and carefully pull it out toward you, without applying unnecessary force.
 3. When inserting the body of the Temperature Controller into the case, make sure the PCBs are parallel to each other, make sure that the sealing rubber is in place, and press the E5CN toward the rear case into position. While pushing the E5CN into place, push down on the hooks on the top and bottom surfaces of the rear case so that the hooks are securely locked in place. Be sure that electronic components do not come into contact with the case.

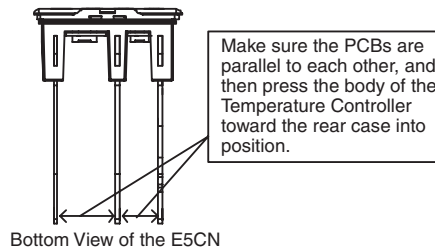

E5AN/EN

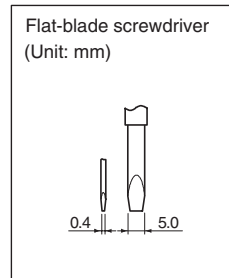
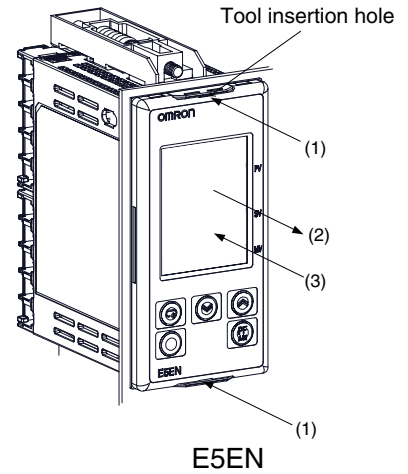
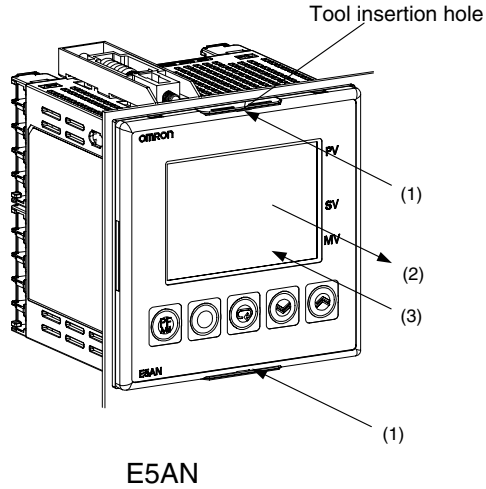

- 1,2,3...**
1. Insert a flat-blade screwdriver into the two tool insertion holes (one on the top and one on the bottom) to release the hooks.
 2. Insert the flat-blade screwdriver in the gap between the front panel and rear case (two on the top and two on the bottom), and use it to pry and pull out the front panel slightly. Then, pull out on the front panel gripping both sides. Be sure not to impose excessive force on the panel.

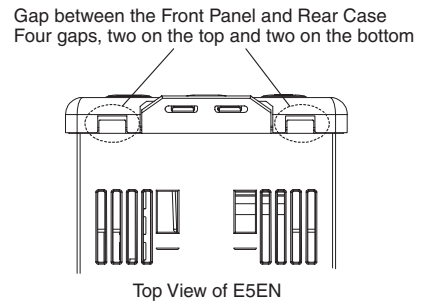
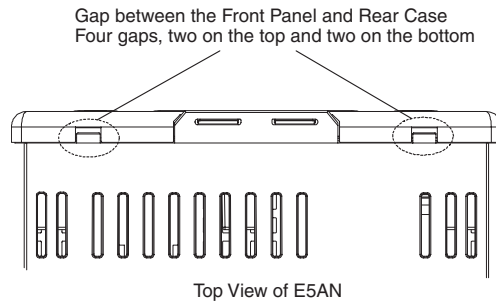

- When inserting the body of the Temperature Controller into the case, make sure the PCBs are parallel to each other, make sure that the sealing rubber is in place, and press the E5AN/EN toward the rear case until it snaps into position. While pressing the E5AN/EN into place, press down on the hooks on the top and bottom surfaces of the rear case so that the hooks securely lock in place. Make sure that electronic components do not come into contact with the case.

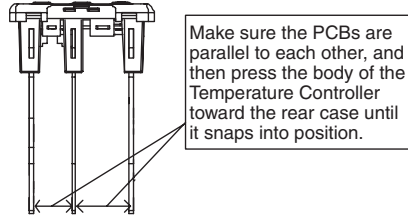

Bottom View of the E5EN

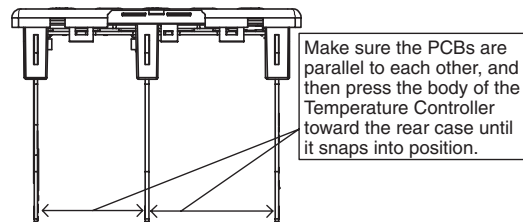

Bottom View of the E5AN

Removing the Terminal Block

The terminal block can be removed from the E5GN. It is not possible for the E5CN, E5AN, E5EN, and E5CN-U.

E5GN

The body of the Controller can be replaced by removing the terminal block from the E5GN.

1,2,3...

- Insert a flat-blade screwdriver into the tool holes (one on the top and one on the bottom) to release the hooks. Do not apply excessive force.

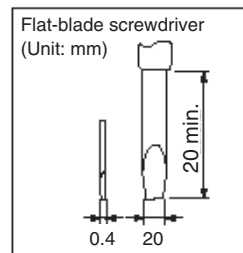
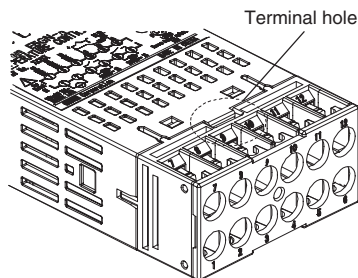

- Pull the terminal block out while the hooks are released.

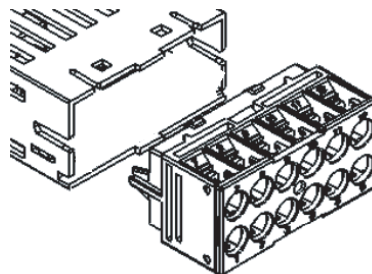

Note The method for removing the terminal block is the same for both screw terminal blocks and screwless clamp terminal blocks.

Do not connect a different type of terminal block to a Controller. For example, do not replace a screw terminal block with a screwless clamp terminal block. The temperature indication accuracy will decrease.

2-2 Wiring Terminals

Confirm the location of the terminals (terminals 1 to 15 for the E5CN, 1 to 30 for the E5AN and E5EN, and terminals 1 to 14 for the E5GN) using the product labels and case markings.

2-2-1 Terminal Arrangement

E5CN Controllers

Control output 1
 Long-life relay output
 250 VAC, 3 A (resistive load)
 Relay output
 250 VAC, 3 A (resistive load)
 Voltage output (for driving SSR)
 12 VDC, 21 mA
 Current output
 0 to 20 mA DC
 4 to 20 mA DC
 Load: 600 Ω max.

Control output 2
 Voltage output (for driving SSR)
 12 VDC, 21 mA

The E5□N-□□□□□□ is set for a K thermocouple (input type of 5) by default. If a difference sensor is used, an input error (5.ERR) will occur. Check the setting of the input type parameter.

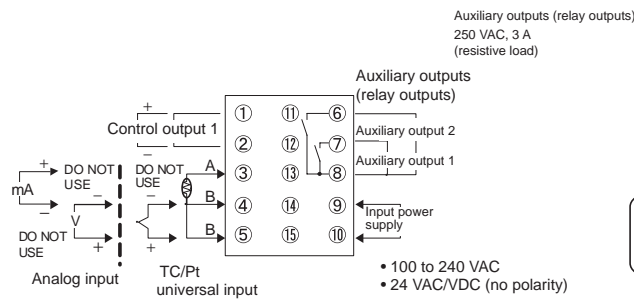

A heater burnout alarm, heater short alarm, heater overcurrent alarm, or input error is sent to the output to which the alarm 1 function is assigned.

Option Units

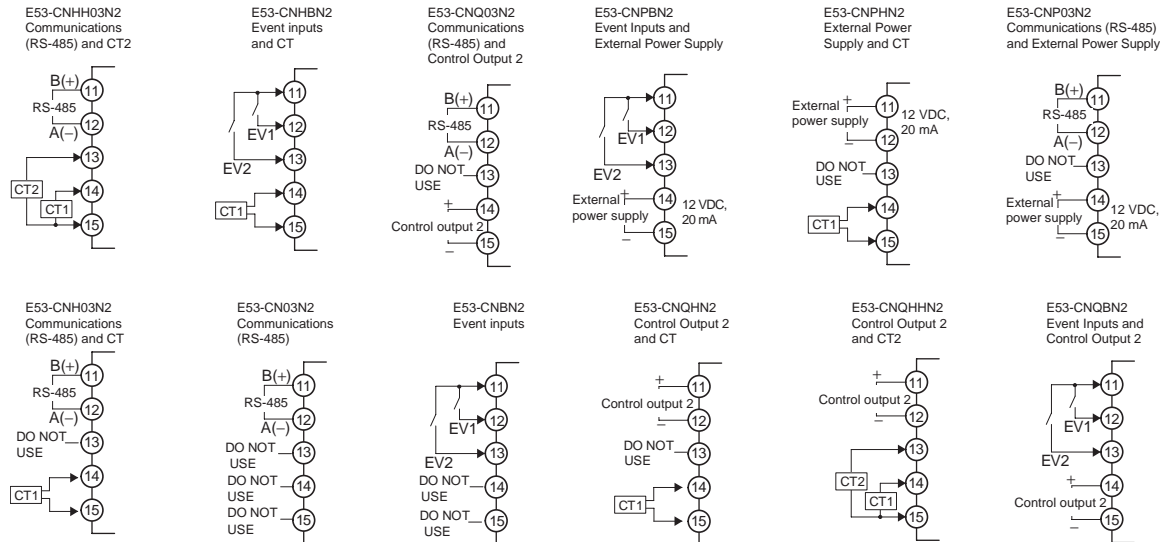

Since the voltage output (control output) is not electrically insulated from the internal wiring, one or other of the control output terminals must be left unearthed when using an earthed thermocouple thermometer. (Connection makes measurements unreliable due to sneak currents.)

To comply with EMC standards, the length of the cable connecting the analog input or universal TC/Pt input sensor must be 30 m or less. If the cable is longer than 30 m, the EMC standards will not be satisfied.

E5CN-U

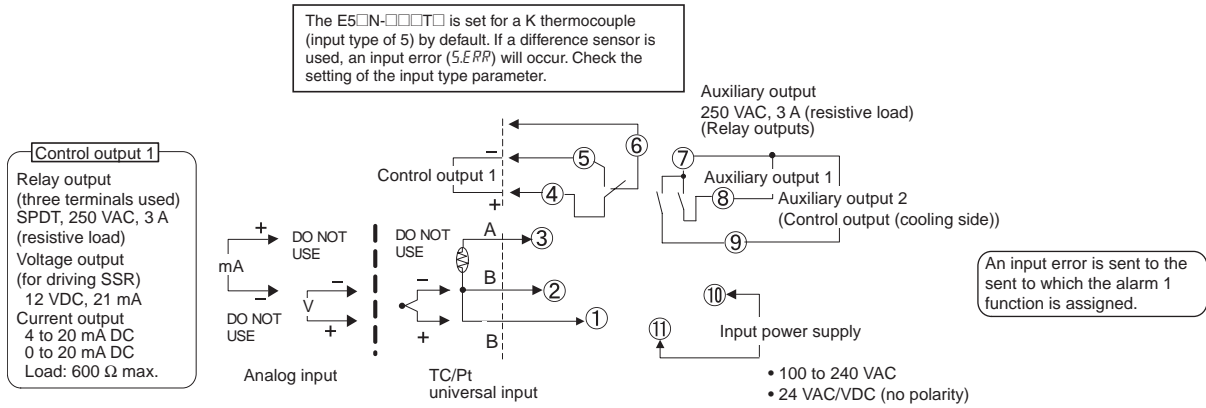

Note For the Wiring Socket, purchase the P2CF-11 or PG3A-11 separately.

Since the voltage output (control output) is not electrically insulated from the internal wiring, one or other of the control output terminals must be left unearthed when using an earthed thermocouple thermometer. (Connection makes measurements unreliable due to sneak currents.)

To comply with EMC standards, the length of the cable connecting the analog input or universal TC/Pt input sensor must be 30 m or less. If the cable is longer than 30 m, the EMC standards will not be satisfied.

E5AN/EN Controllers

Option Units

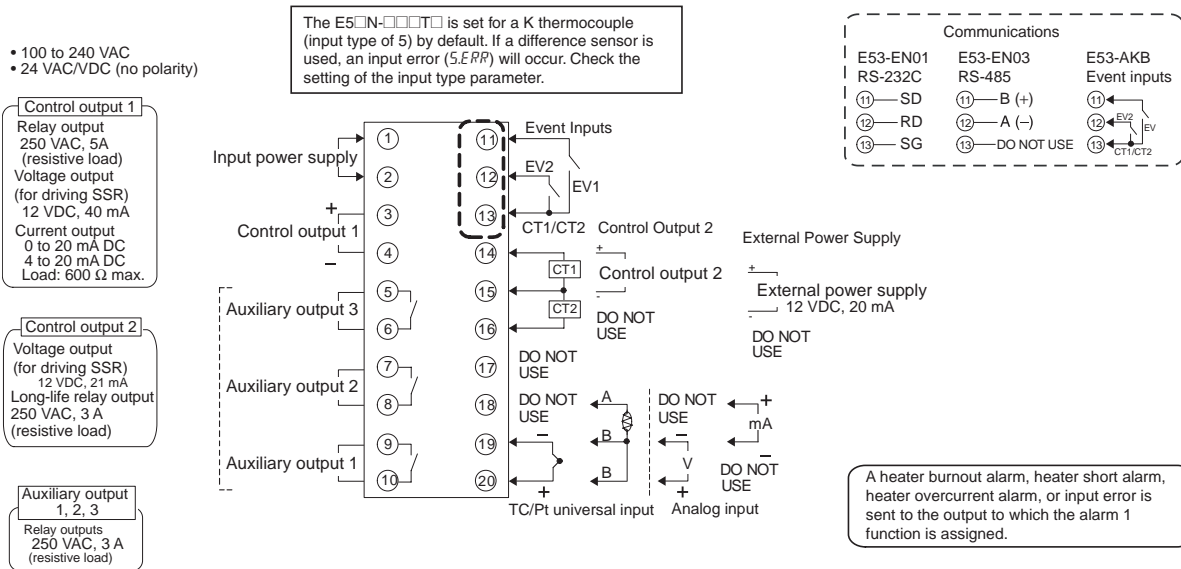

Since the voltage output (control output) is not electrically insulated from the internal wiring, one or other of the control output terminals must be left unearthed when using an earthed thermocouple thermometer. (Connection makes measurements unreliable due to sneak currents.)

To comply with EMC standards, the length of the cable connecting the analog input or universal TC/Pt input sensor must be 30 m or less. If the cable is longer than 30 m, the EMC standards will not be satisfied.

E5GN

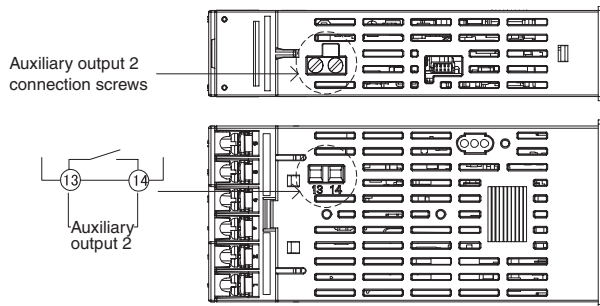
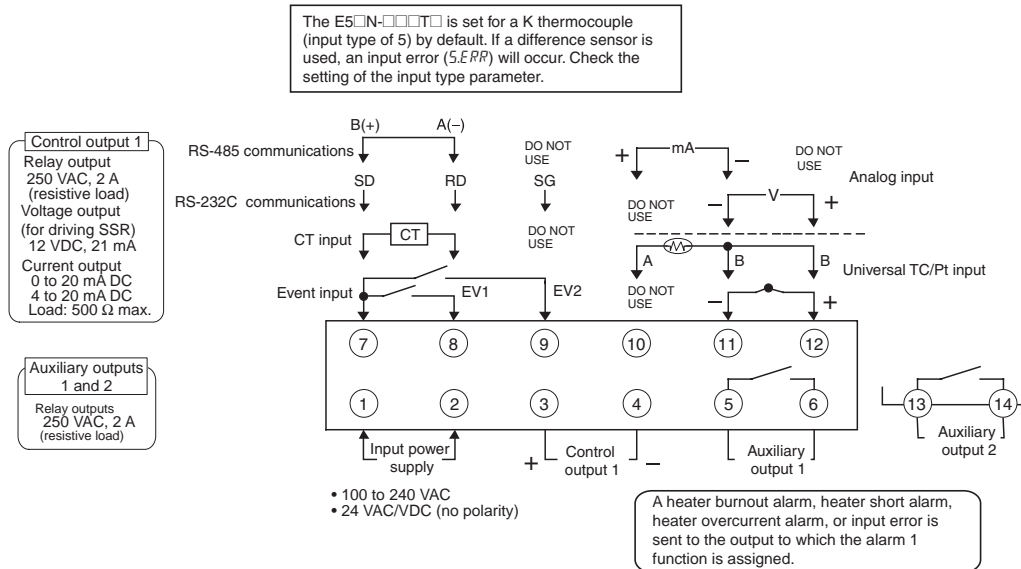

Since the voltage output (control output) is not electrically insulated from the internal wiring, one or other of the control output terminals must be left unearthed when using an earthed thermocouple thermometer. (Connection makes measurements unreliable due to sneak currents.)

To comply with EMC standards, the length of the cable connecting the analog input or universal TC/Pt input sensor must be 30 m or less. If the cable is longer than 30 m, the EMC standards will not be satisfied.

2-2-2 Precautions when Wiring

- Separate input leads and power lines in order to prevent external noise.
- Use a shielded, AWG24 to AWG14 (cross-sectional area of 0.205 to 2.081 mm²) twisted-pair cable for the E5CN, E5EN, or E5AN. Use a shielded, AWG24 to AWG18 (cross-sectional area of 0.205 to 0.823 mm²) twisted-pair cable for the E5GN. The stripping length is 5 to 6 mm for the E5CN, E5AN, or E5EN, and 6 to 8 mm for the E5GN.
- Use crimp terminals when wiring the terminals.
- Use the suitable wiring material and crimp tools for crimp terminals.
- Tighten the terminal screws to a torque of 0.5 N·m for the E5CN-U and E5GN and to 0.74 to 0.90 N·m for other models. The terminal torque is 0.5 to 0.6 N·m for auxiliary output 2 on the E5GN.
- For the E5CN, E5AN, or E5EN, use the following types of crimp terminals for M3.5 screws.



- For the E5GN, use the following types of crimp terminals for M3.0 screws.



- For E5GN screwless clamp terminal blocks, use wires with a gauge of AWG24 to AWG18 (equal to a cross-sectional area of 0.205 to 0.823 mm²). The length of the conductive portion inserted into the terminal must be 10 mm for wires and 8 to 12 mm for ferrules. Ferrules must be 0.8 to 1.4 mm in diameter.

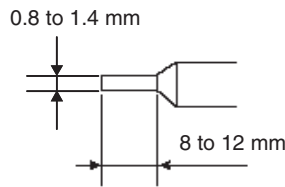

Ferrules

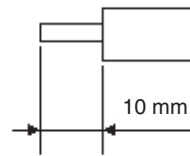

wires

- Recommended Ferrules for E5GN Screwless Clamp Terminals

Manufacturer		Model number
Altech Corp.		2623.0
Daido Solderless Terminal Mfg. Co.		AVA-0.5
J.S.T. Mfg. Co.		TUB-0.5
Nichifu Co.	Single (1 wire)	TGNTC-1.25-9T TGVTC-1.25-11T TGNTC-1.25-11T TC0.3-9.5 TC1.25-11S-ST TC1.25-11S TC2-11S
	Double (2 wires)	TGWVTC-1.25-9T TGWVTC-1.25-11T

- Use wires with a gauge of AWG24 to AWG18 (0.205 to 0.823 mm²) for auxiliary output 2 on the E5GN. The exposed conductor length inserted into the terminal for wires or ferrules must be 6 mm. Ferrules must be 0.8 to 1.5 mm in diameter.

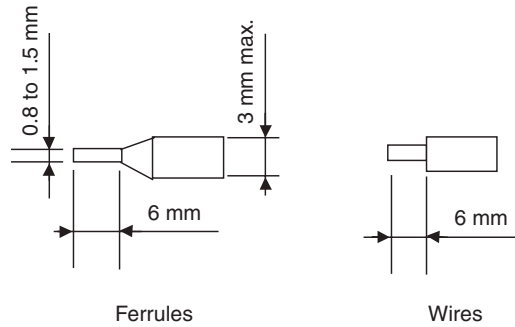

- Recommended Ferrules for SUB2 on E5GN

Manufacturer	Model number
Phoenix Contact	AI 0,25-6 BU
	AI 0,34-6 TQ
	AI 0,5-6 WH
	AI 0,75-6 GY
	AI 1-6 RD

Note Do not remove the terminal block from the E5AN, E5EN, or E5CN. Doing so may cause product malfunction or incorrect operation.

2-2-3 Wiring

In the connection diagrams, the left side of the terminal numbers represents the inside of the Controller and the right side represents the outside.

Power supply

- With the E5CN, connect to terminals 9 and 10; with the E5CN-U, connect to pins 10 and 11; with the E5AN, E5EN, and E5GN, connect pins 1 and 2. The following table shows the specifications.

Input power supply	E5CN	E5CN-U	E5AN/EN	E5GN
100 to 240 VAC, 50/60 Hz	7.5 VA	6 VA	10 VA	5.5 VA
24 VAC, 50/60 Hz	5 VA	3 VA	5.5 VA	3 VA
24 VDC (no polarity)	3 W	2 W	4 W	2 W

- These models have reinforced insulation between the input power supply, the relay outputs, and other terminals.

Input

- Make the connections according to the input type as shown below, using terminals 3 to 5 for the E5CN, pins 1 to 3 for the E5CN-U, pins 18 to 20 for the E5AN or E5EN and pins 10 to 12 for the E5GN.

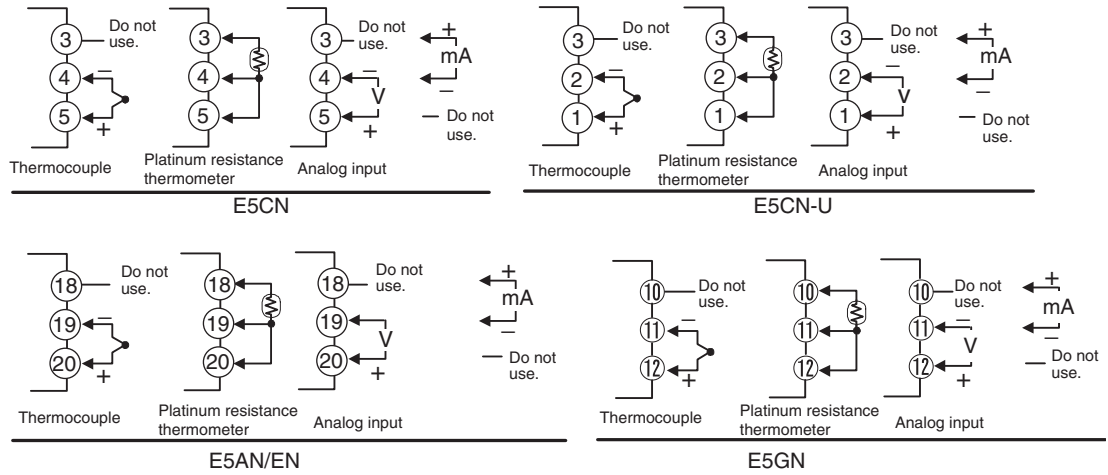

When extending the thermocouple lead wires, be sure to use compensating wires that match the thermocouple type. When extending the lead wires of a platinum resistance thermometer, be sure to use wires that have low resistance and keep the resistance of the three lead wires the same.

Control Output 1

- Outputs are sent from terminals 1 and 2 with the E5CN, from pins 4 to 6 with the E5CN-U, and from pins 3 and 4 with the E5AN/EN/GN. The following diagrams show the available outputs and their internal equalizing circuits.

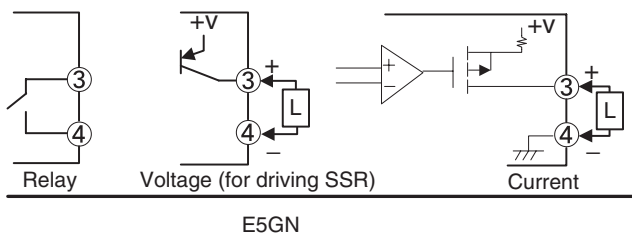
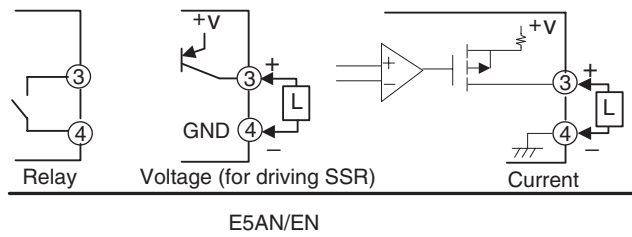
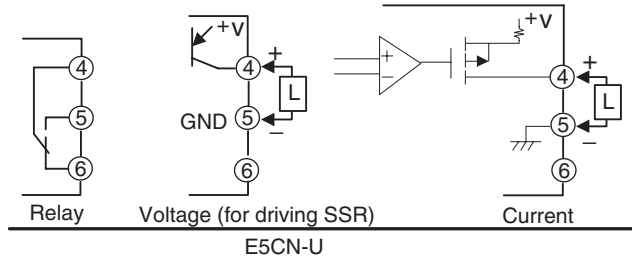
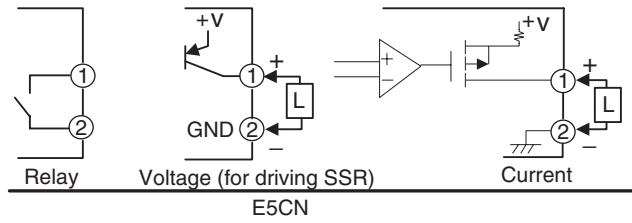

- The following table shows the specifications for each output type.

E5CN/CN-U

Output type	Specifications
Relay	250 VAC, 3 A (resistive load), electrical durability: 100,000 operations
Long-life relay (using a triac)	250 VAC, 3 A (resistive load), electrical durability: 1,000,000 operations
Voltage (for driving SSR)	PNP type, 12 VDC \pm 15%, 21 mA (with short-circuit protection)
Current	DC 4 to 20 mA/DC 0 to 20 mA, resistive load: 600 Ω max. Resolution: Approx. 10,000

E5AN/EN

Output type	Specifications
Relay	250 VAC, 5 A (resistive load), electrical durability: 100,000 operations
Voltage (for driving SSR)	PNP type, 12 VDC +15%, 40 mA (with short-circuit protection)
Current	DC 4 to 20 mA/DC 0 to 20 mA, resistive load: 600 Ω max. Resolution: Approx. 10,000

E5GN

Output type	Specifications
Relay	250 VAC, 2 A (resistive load), electrical durability: 100,000 operations
Voltage (for driving SSR)	PNP type, 12 VDC ±15%, 21 mA (with short-circuit protection)
Current	DC 4 to 20 mA/DC 0 to 20 mA, resistive load: 500 Ω max. Resolution: Approx. 10,000

- Always connect an AC load to a long-life relay output. The output will not turn OFF if a DC load is connected.
- The voltage output (for driving SSR) is not electrically isolated from the internal circuits. When using a grounding thermocouple, do not connect any of the control output terminals to the ground. If a control output terminal is connected to the ground, errors will occur in the measured temperature as a result of leakage current.
- Control output 1 (voltage output for driving SSR) and control output 2 (voltage output for driving SSR) are not isolated. For the E5AN/EN, however, the internal circuits are functionally isolated.
- Long-life relay outputs use semiconductors for switching when closing and opening the circuit, thereby reducing chattering and arcing and improving durability. However, if high levels of noise or surge are imposed between the output terminals, short-circuit faults may occasionally occur. If the output becomes permanently shorted, there is the danger of fire due to overheating of the heater. Design safety into the system, including measures to prevent excessive temperature rise and spreading of fire.
- Take countermeasures such as installing a surge absorber. As an additional safety measure, provide error detection in the control loop. (Use the Loop Burnout Alarm (LBA) and HS alarm that are provided for the E5□N.)

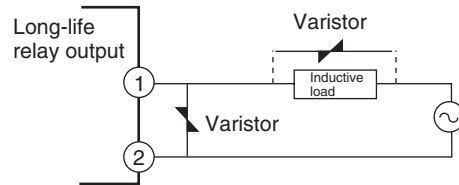

Select a surge absorber that satisfies the following conditions.

Voltage used	Varistor voltage	Surge resistance
100 to 120 VAC	240 to 270 V	1,000 A min.
200 to 240 VAC	440 to 470 V	

Control Output 2

- Outputs are sent from terminals 11, 12, 14, and 15 with the E5CN, and from pins 14 and 15 with the E5AN/EN. The following diagrams show the available outputs and their internal equalizing circuits.

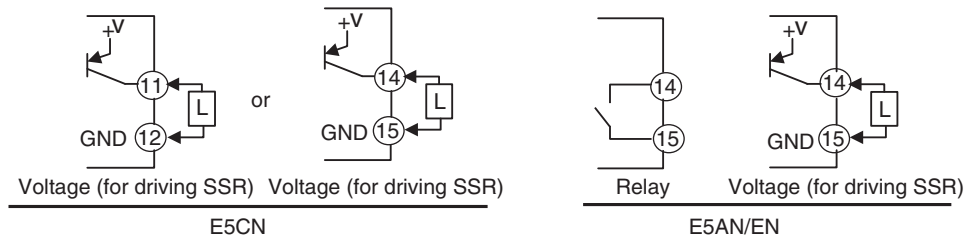

- The following table shows the specifications for each output type.

E5CN

Output type	Specifications
Voltage (for driving SSR)	PNP type, 12 VDC \pm 15%, 21 mA (with short-circuit protection)

E5AN/EN

Output type	Specifications
Long-life relay (using a triac)	250 VAC, 3 A (resistive load), electrical durability: 1,000,000 operations
Voltage (for driving SSR)	PNP type, 12 VDC \pm 15%, 21 mA (with short-circuit protection)

- Always connect an AC load to a long-life relay output. The output will not turn OFF if a DC load is connected.
- The voltage output (for driving SSR) is not electrically isolated from the internal circuits. Therefore, when using a grounding thermocouple, do not connect any of the control output terminals to the ground. If a control output terminal is connected to the ground, errors will occur in the measured temperature as a result of leakage current. With E5AN/EN, however, control output 2 (voltage output for driving SSR) is functionally isolated from the internal circuits.
- Control output 2 of the E5CN is a voltage output (for driving SSR) only, and outputs across terminals 11(+) and 12(-), or 14(+) and 15(-).
- Control output 1 (voltage output for driving SSR) and control output 2 (voltage output for driving SSR) are not isolated.
- Long-life relay outputs use semiconductors for switching when closing and opening the circuit, thereby reducing chattering and arcing and improving durability. However, if high levels of noise or surge are imposed between the output terminals, short-circuit faults may occasionally occur. If the output becomes permanently shorted, there is the danger of fire due to overheating of the heater. Design safety into the system, including measures to prevent excessive temperature rise and spreading of fire.

- Take countermeasures such as installing a surge absorber. As an additional safety measure, provide error detection in the control loop. (Use the Loop Burnout Alarm (LBA) and HS alarm that are provided for the E5□N.)

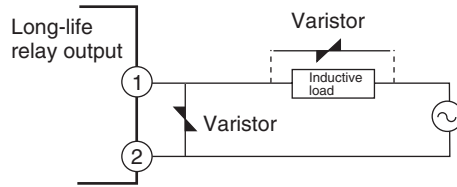

Select a surge absorber that satisfies the following conditions.

Voltage used	Varistor voltage	Surge resistance
100 to 120 VAC	240 to 270 V	1,000 A min.
200 to 240 VAC	440 to 470 V	

Auxiliary Outputs 1, 2, and 3

- On the E5CN-□2□□□, auxiliary output 1 (SUB1) is output across terminals 7 and 8, and auxiliary output 2 (SUB2) is output across terminals 6 and 8.
- On the E5CN-□1□□□U, auxiliary output 1 (SUB1) is output across terminals 7 and 8.
- On the E5CN-□2□□□U, auxiliary output 1 (SUB1) is output across terminals 7 and 8, and auxiliary output 2 (SUB2) is output across terminals 7 and 9.
- On the E5AN/EN-□3□□□, auxiliary output 1 (SUB1) is output across terminals 9 and 10, auxiliary output 2 (SUB2) is output across terminals 7 and 8, and auxiliary output 3 (SUB3) is output across terminals 5 and 6.
- On the E5GN-□2□□□, auxiliary output 1 (SUB1) is output across terminals 5 and 6, and auxiliary output 2 (SUB2) is output across terminals 13 and 14 on the bottom of the Controller. Wire terminals 13 and 14 and tighten the screws.
- When the Input Error Output parameter is set to ON, the output assigned to the alarm 1 function turns ON when an input error occurs.
- When the HB alarm, HS alarm, or heater overcurrent alarm is used with the E5CN-□□H□, E5CN-□□HH□, or E5GN-□□H□, alarms are output to the output assigned to the alarm 1 function.
- When the HB alarm, HS alarm, or heater overcurrent alarm is used with the E5AN/EN-□□H□□, alarms are output to the output assigned to the alarm 1 function.
- On the E5CN and E5CN-U, when heating/cooling control is used, auxiliary output 2 becomes control output (cooling).
- On the E5AN and E5EN, when heating/cooling control is used, auxiliary output 3 becomes control output (cooling).
- On the E5GN, when heating/cooling control is used, auxiliary output 1 becomes control output (cooling).
- For models that have a heater burnout alarm, an OR of the alarm 1 function and the HB alarm, HS alarm, or heater overcurrent alarm is sent to the output assigned to the alarm 1 function (auxiliary output 1). If the alarm 1 function is to be used for HB alarm only, set the alarm 1 type to 0 (i.e., do not use alarm 1 function).
- The following diagrams show the internal equalizing circuits for auxiliary outputs 1, 2, and 3.

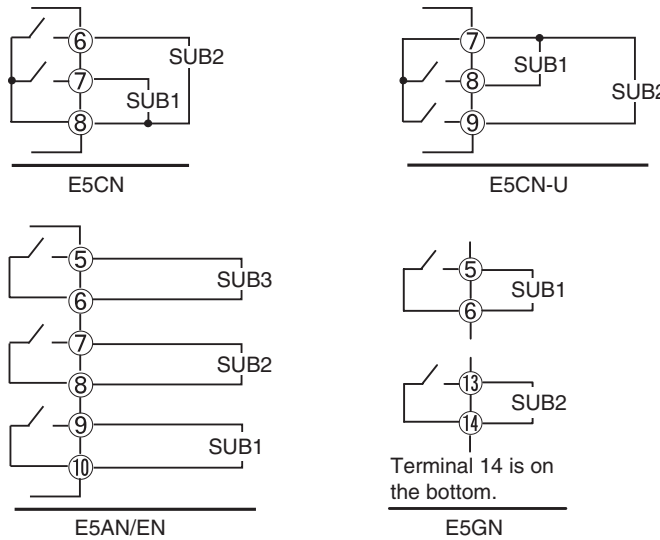

ALM1, 2, 3 can be output to auxiliary output 1, 2, 3, or changed with the advanced function setting level.

- The relay specifications are as follows:

E5CN/AN/EN	SPST-NO, 250 VAC, 3 A
E5GN	SPST-NO, 250 VAC, 2 A

Event Inputs

- The E5□N-□□□B supports event inputs. When event inputs 1/2 are to be used, connect to terminals 11 to 13 or terminals 7 to 9. When event inputs 3/4 are to be used, connect to terminals 23 to 25.

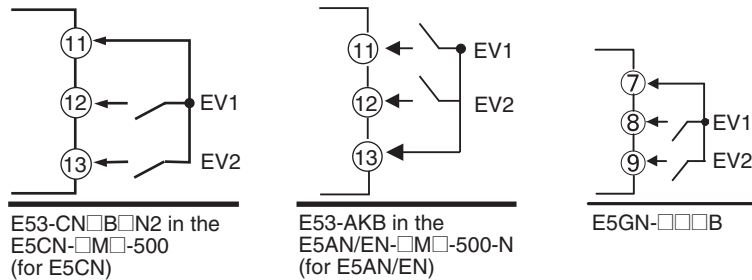

- Use event inputs under the following conditions:
- The outflow current is approximately 7 mA.

Contact input	ON: 1 kΩ max., OFF: 100 kΩ min.
No-contact input	ON: Residual voltage 1.5 V max.; OFF: Leakage current 0.1 mA max.

Polarities during no-contact input are as follows:

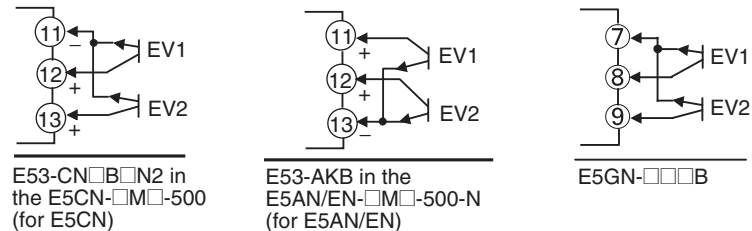

CT Inputs

- When the HB alarm, HS alarm, or heater overcurrent alarm is to be used with the E5CN-□M□-500 with an E53-CN□H/HH□N2 Option Unit, connect a current transformer (CT) across terminals 14 and 15 or terminals 13 and 15 (no polarity).
- When the HB alarm, HS alarm, or heater overcurrent alarm is to be used with the E5AN/EN-□□H□-500-N or E5AN/EN-□□HH□-500-N, connect a current transformer (CT) across terminals 14 and 15 or terminals 15 and 16 (no polarity).
- When using the HB alarm, HS alarm, or heater overcurrent alarm with the E5GN-□□H□, connect the current transformer (CT) across terminals 7 and 8. (no polarity)

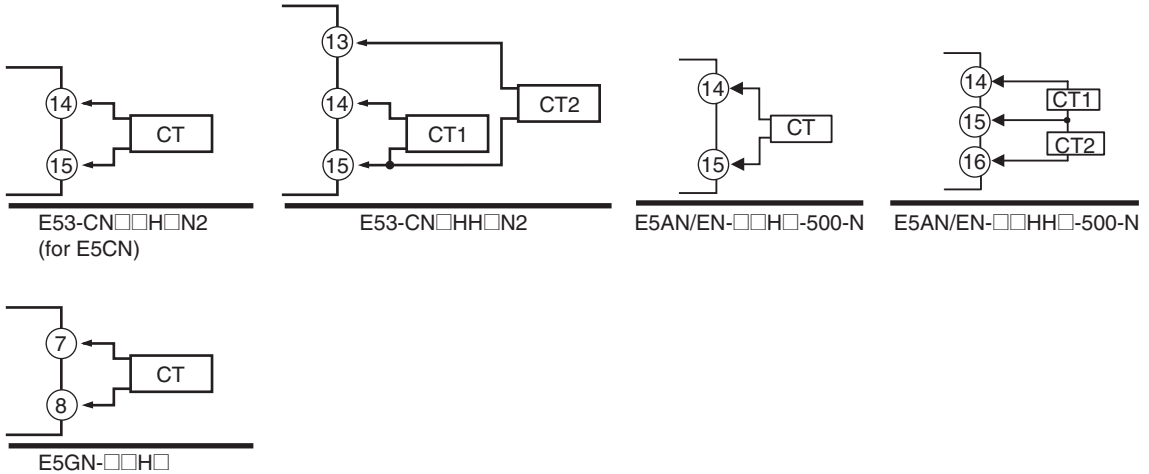

Communications

RS-485

- When communications are to be used with the E5□N-□□□03, connect communications cable across terminals 11 and 12, terminals 21 and 22, or terminals 7 and 8.

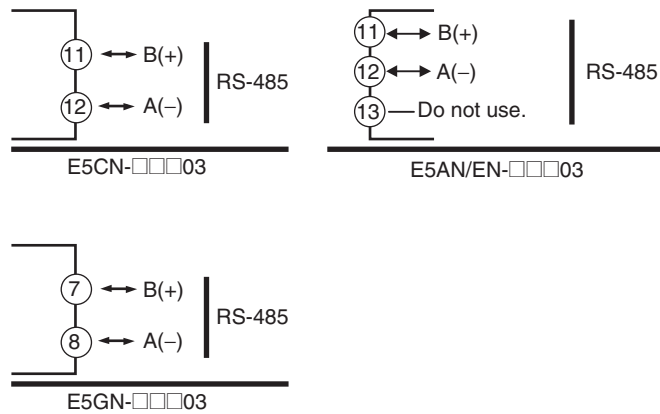

Specify both ends of the transmission path including the host computer as end nodes (that is, connect terminators to both ends).
The minimum terminal resistance is 54 Ω.

Communications Unit Connection Diagram

E5CN

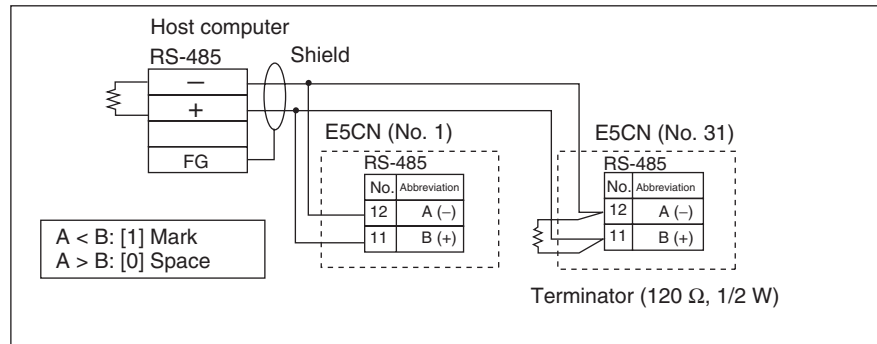

E5AN/EN

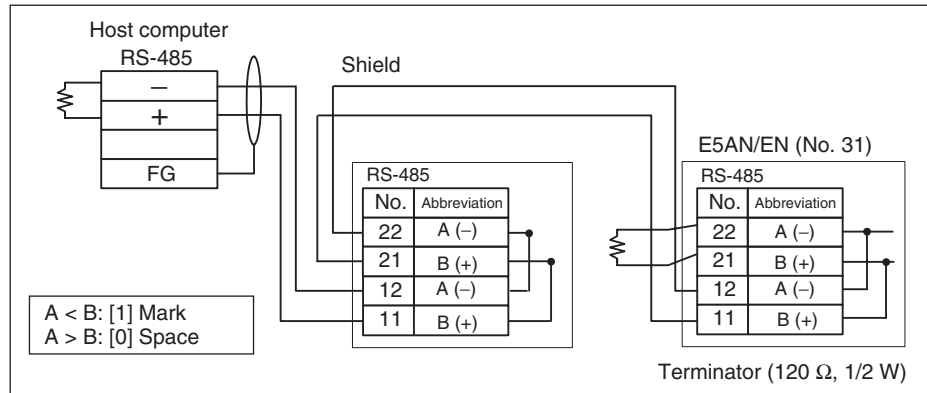

E5GN

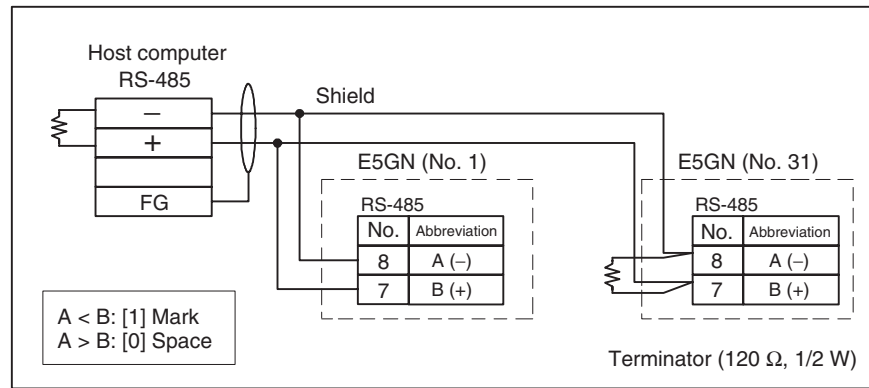

- The RS-485 connection can be either one-to-one or one-to-N. A maximum of 32 Units (including the host computer) can be connected in one-to-N systems. The maximum total cable length is 500 m. Use a shielded, AWG24 to AWG14 (cross-sectional area of 0.205 to 2.081 mm²) twisted-pair cable for the E5CN, E5EN, or E5AN. Use a shielded, AWG24 to AWG18 (cross-sectional area of 0.205 to 0.823 mm²) twisted-pair cable for the E5GN.

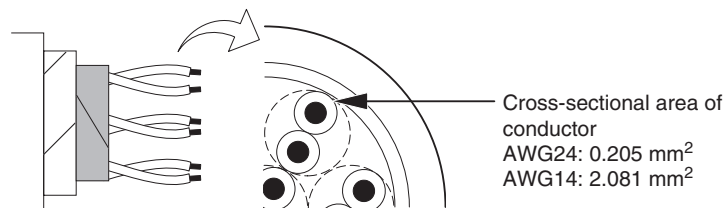

RS-232C (E5AN/EN/GN Only)

- When communications are to be used with the E5AN/E5EN/E5GN-□□□01□, connect communications cable across terminals 11 to 13 or terminals 7 to 9.

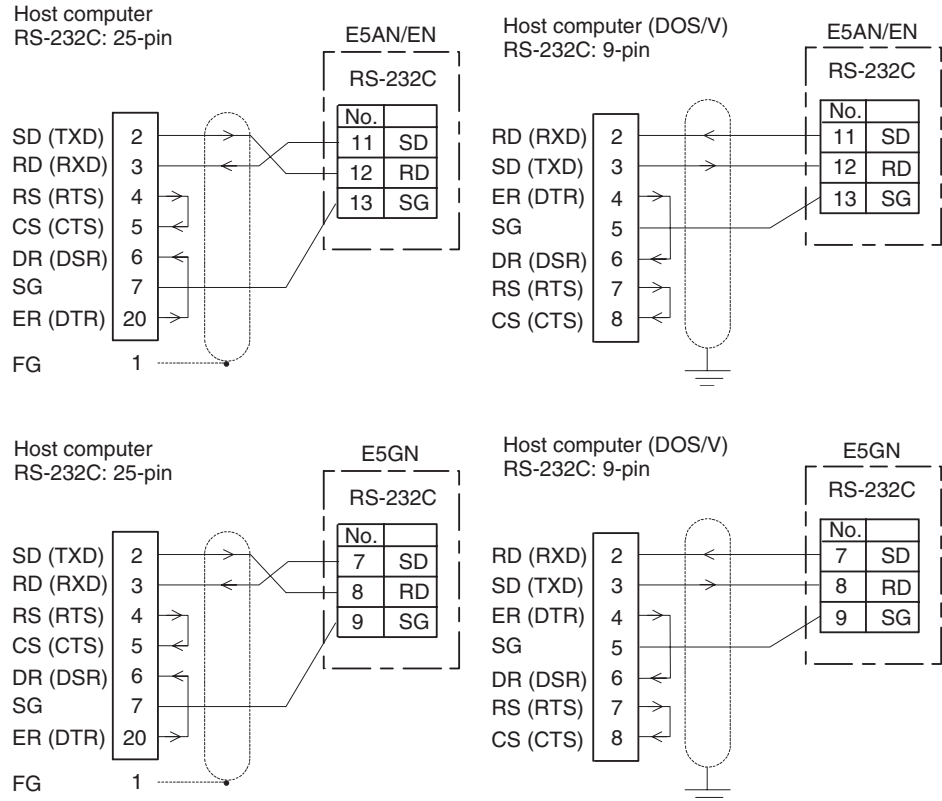
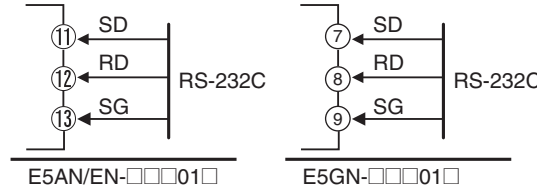

- A 1:1 connection is used. The maximum cable length is 15 m. To extend the transmission path, use the OMRON Z3R RS-232C Optical Interface.
- Use a shielded, AWG24 to AWG14 (cross-sectional area of 0.205 to 2.081 mm²) twisted-pair cable for the E5CN, E5EN, or E5AN. Use a shielded, AWG24 to AWG18 (cross-sectional area of 0.205 to 0.823 mm²) twisted-pair cable for the E5GN.

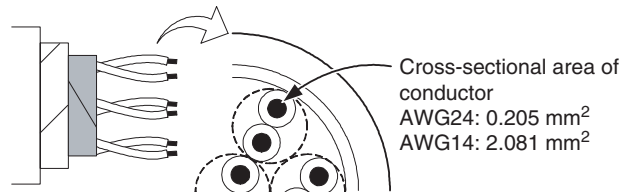

External Power Supply for ES1B

- Connect terminals 11 and 12 when using the E53-CN□□PH□N2 as the external power supply for the ES1B.

- Connect terminals 14 and 15 when using the E53-CN□□PBN2 as the external power supply for the ES1B.
- Connect terminals 14 and 15 when using the E5AN/EN-□□P□-N as the external power supply for the ES1B.

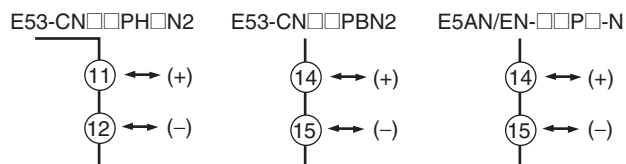

- The following table provides the specifications of the external power supply for ES1B.

Output voltage	12 VDC \pm 10%
Output current	20 mA max.

Note Contact your OMRON representative for information on using the external power supply for ES1B for other applications.

2-3 Using the Support Software Port

Use the communications port for Support Software to connect the personal computer to the Temperature Controller when using EST2-2C-MV4 CX-Thermo or a version of CX-Thermo higher than 4.00, or other Support Software. The E5GN is supported from CX-Thermo version 4.2. The E58-CIFQ1 USB-Serial Conversion Cable is required to make the connection.

For information concerning the models that can be used with CX-Thermo, contact your OMRON sales representative.

Procedure

Use the following procedure to connect the Temperature Controller to the personal computer using the USB-Serial Conversion Cable. The USB-Serial Conversion Cable is used to communicate with the COM port of the personal computer. To perform communications using USB-Serial Conversion Cable, set the communications port (COM port) number to be used for the software to the COM port assigned to the Cable.

1,2,3...

1. Turn ON the power to the Temperature Controller.

Note If the Cable is connected when the power to the Temperature Controller is OFF, power will be supplied from the personal computer and impose a load on the internal circuits of the Temperature Controller.

2. Connect the Cable.

Connect the personal computer's USB port with the Support Software port on the Temperature Controller using the Cable.

• Temperature Controller Connection Method

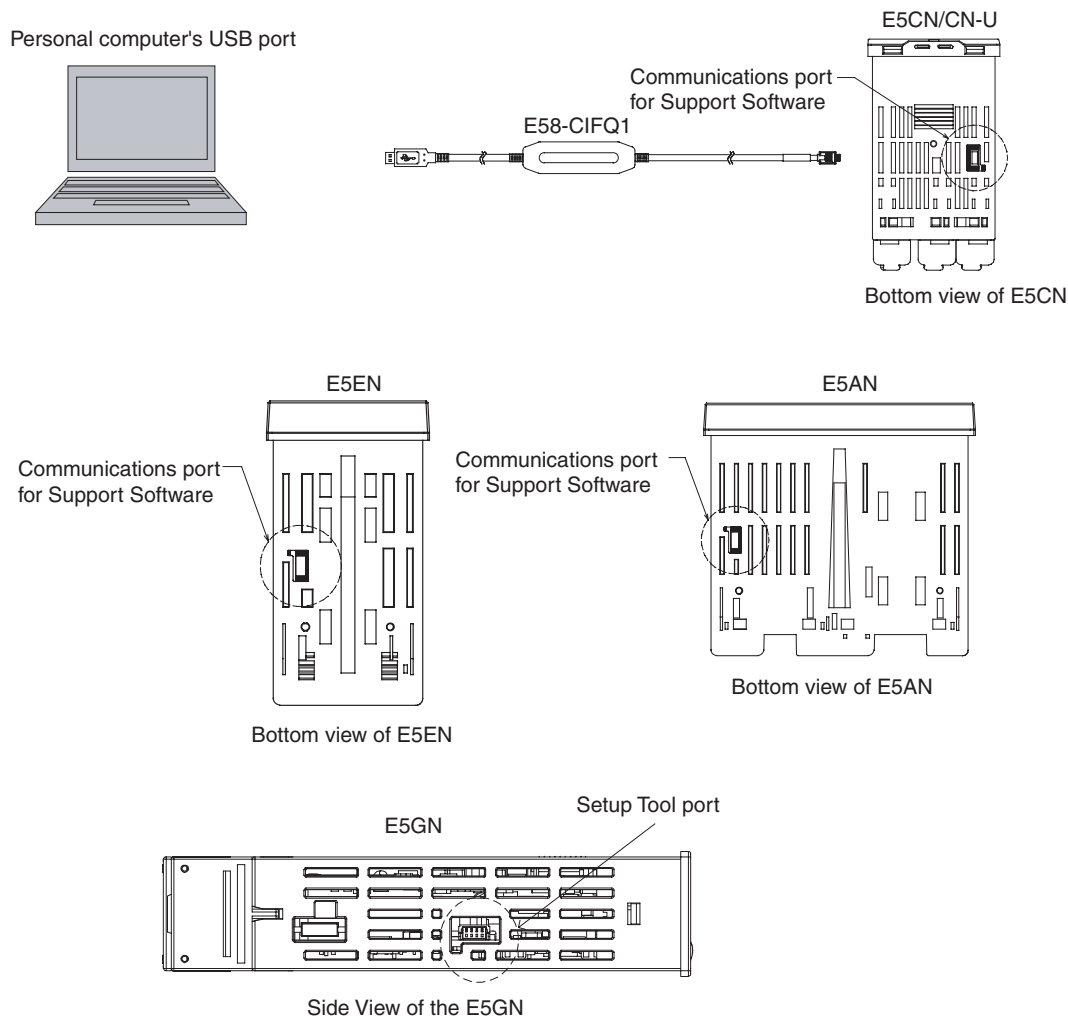

Note Hold the connector when inserting or disconnecting the Cable.

3. Install the driver.
Install the driver to enable the Cable to be used with the personal computer.
- Installation
When the Cable is connected with the personal computer, the OS detects the product as a new device. At this time, install the driver using the installation wizard. For details on installation methods, refer to the user's manual for the E58-CIFQ1 USB-Serial Conversion Cable.
4. Setting Setup Tool Communications Conditions
Set the communications port (COM port) number to be used for the CX-Thermo Setup Tool to the COM port number assigned to the USB-Serial Conversion Cable.
Refer to the E58-CIFQ1 USB-Serial Conversion Cable *Instruction Manual*

and *Setup Manual* for details on how to check the COM port assigned to the USB-Serial Conversion Cable.

The communications conditions for Setup Tool COM ports are fixed as shown in the table below. Set the communications conditions for the CX-Thermo Setup Tool according to the following table.

Parameter	Set value
Communications Unit No.	01
Communications baud rate	38.4 (kbps)
Communications data length	7 (bits)
Communications stop bits	2 (bits)
Communications parity	Even



SECTION 3

Basic Operation

This section describes the basic operation of the E5CN, E5AN, and E5EN Digital Temperature Controllers, including key operations to set parameters and descriptions of display elements based on specific control examples.

3-1	Initial Setting Examples	50
3-2	Setting the Input Type	52
3-2-1	Input Type	52
3-3	Selecting the Temperature Unit	54
3-3-1	Temperature Unit	54
3-4	Selecting PID Control or ON/OFF Control	54
3-5	Setting Output Specifications	54
3-5-1	Control Periods	54
3-5-2	Direct and Reverse Operation	55
3-5-3	Assigned Output Functions	56
3-6	Setting the Set Point (SP)	59
3-6-1	Changing the SP	59
3-7	Using ON/OFF Control	60
3-7-1	ON/OFF Control	60
3-7-2	Settings	61
3-8	Determining PID Constants (AT, ST, Manual Setup)	62
3-8-1	AT (Auto-tuning)	62
3-8-2	ST (Self-tuning)	64
3-8-3	RT (Robust Tuning)	66
3-8-4	Manual Setup	68
3-9	Alarm Outputs	69
3-9-1	Alarm Types	69
3-9-2	Alarm Values	71
3-10	Using Heater Burnout, Heater Short, and Heater Overcurrent Alarms	73
3-10-1	Heater Burnout, Heater Short, and Heater Overcurrent Alarm Operations	73
3-10-2	Installing Current Transformers (CT)	74
3-10-3	Calculating Detection Current Values	75
3-10-4	Application Examples	76
3-10-5	Settings: HB Alarm	80
3-10-6	Settings: Heater Short Alarm	81
3-10-7	Settings: Heater Overcurrent Alarm	82
3-11	Setting the No. 3 Display	84
3-11-1	PV/SP Display Selection	84

3-1 Initial Setting Examples



Initial hardware setup, including the sensor input type, alarm types, control periods, and other settings, is done using parameter displays. The  and  Keys are used to switch between parameters, and the amount of time that you press the keys determines which parameter you move to.

This section describes two typical examples.

Explanation of Examples

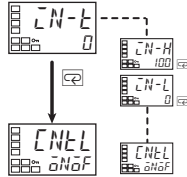

Changing Parameters

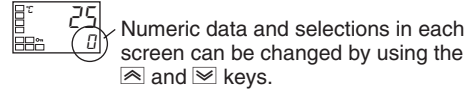

A  image means that there are parameters. Continue pressing the  key for change parameters until you reach the intended parameter.

Changing Numbers



Numeric data and selections in each screen can be changed by using the  and  keys.

Example 1

Input type: 5 (K thermocouple, -200°C to 1,300°C)
 Control method: ON/OFF control
 Alarm type: 2 (upper limit)
 Alarm value 1: 20°C (deviation)
 Set point: 100°C

Setup Procedure

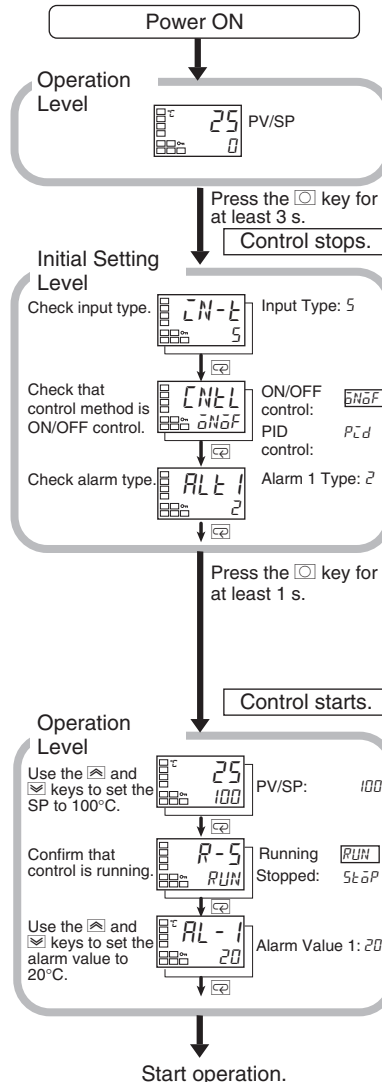
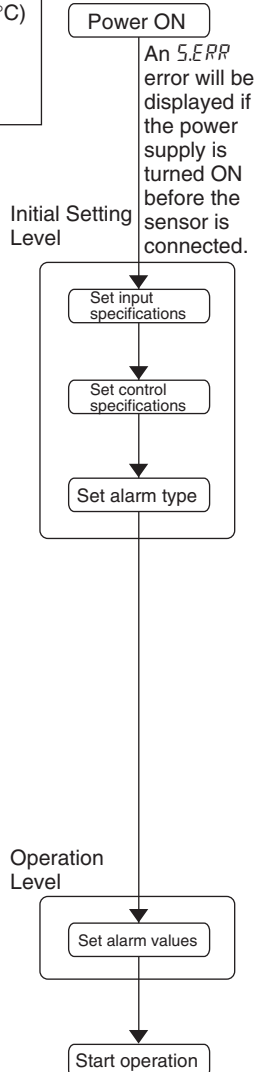

Example 2

Input type: 9 (T thermocouple, -200°C to 400°C)
 Control method: PID control
 PID constants found using auto-tuning (AT).
 Alarm type: 2 upper limit
 Alarm value 1: 30°C
 Set point: 150°C

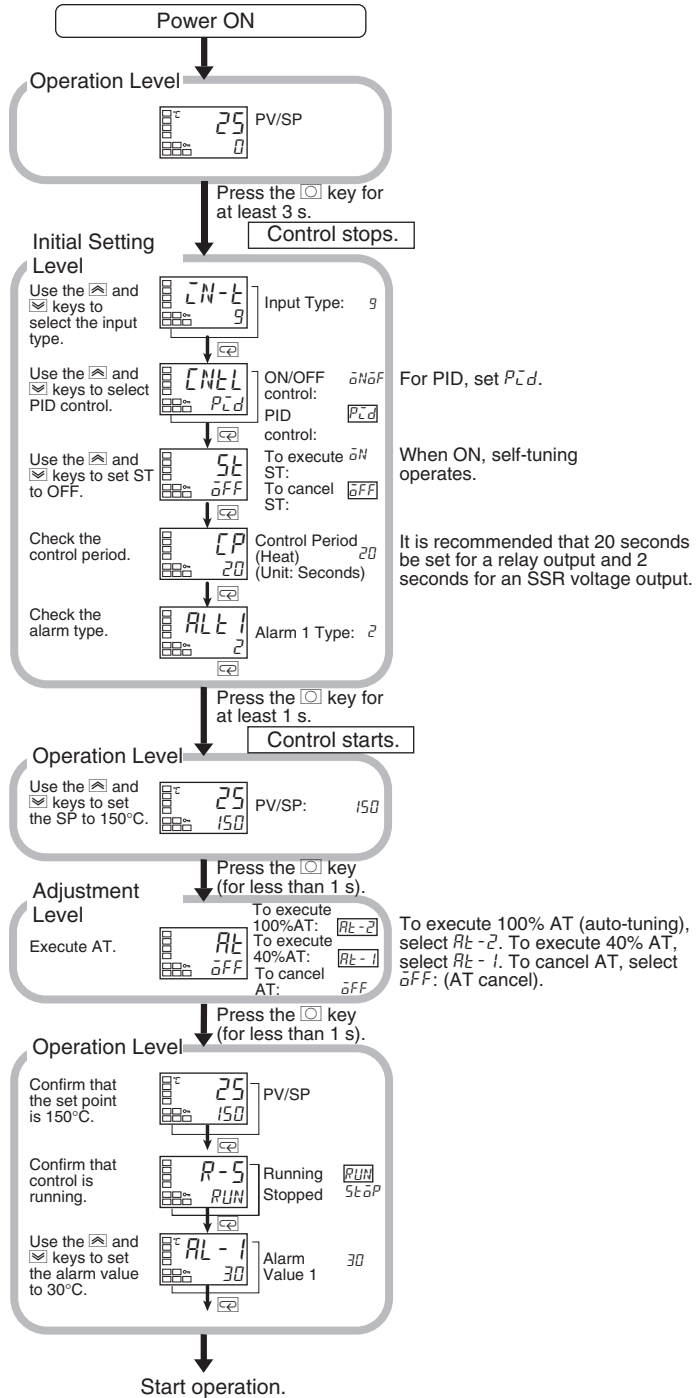
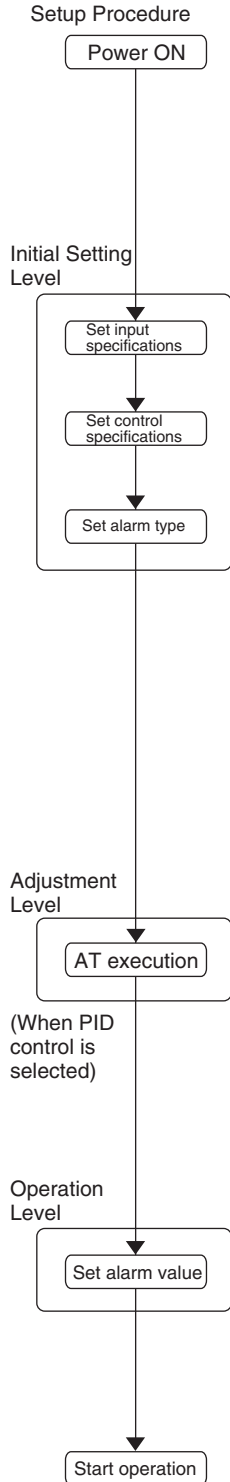

PV/SP after AT is stopped
 PV: 25, SP: 150

The set point flashes during auto-tuning (AT) execution.

After AT is stopped
 PV: 26, SP: -150

During AT execution
 PV: AL, SP: OFF

During AT execution
 PV: AL, SP: AL-1

3-2 Setting the Input Type

The Controller supports four input types: platinum resistance thermometer, thermocouple, infrared temperature sensor, and analog inputs. Set the input type that matches the sensor that is used. In the product specifications, there are models with thermocouple/resistance thermometer inputs (universal inputs) and models with analog input. The settings differ depending on the model. Check to make sure which model you are using.

3-2-1 Input Type

The following example shows how to set a K thermocouple for -20.0 to 500.0°C .

Operating Procedure

Operation Level

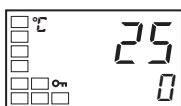



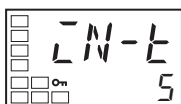

Initial Setting Level

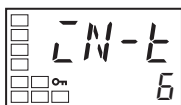

Input Type



1. Press the  Key for at least three seconds to move from the operation level to the initial setting level.
2. Press the  Key to enter the set value of the desired sensor. When you use a K thermocouple (-20.0 to 500.0°C), enter 6 as the set value.

Hint: The key operation is saved two seconds after the change, or by pressing the  or  Key.

List of Input Types

	Input type	Specifications	Set value	Input temperature setting range
Controllers with Thermocouple/Resistance Thermometer Multi-input	Platinum resistance thermometer	Pt100	0	–200 to 850 (°C)/–300 to 1,500 (°F)
			1	–199.9 to 500.0 (°C)/–199.9 to 900.0 (°F)
			2	0.0 to 100.0 (°C)/0.0 to 210.0 (°F)
		JPt100	3	–199.9 to 500.0 (°C)/–199.9 to 900.0 (°F)
	4		0.0 to 100.0 (°C)/0.0 to 210.0 (°F)	
	Thermocouple	K	5	–200 to 1,300 (°C)/–300 to 2,300 (°F)
			6	–20.0 to 500.0 (°C)/0.0 to 900.0 (°F)
		J	7	–100 to 850 (°C)/–100 to 1,500 (°F)
			8	–20.0 to 400.0 (°C)/0.0 to 750.0 (°F)
		T	9	–200 to 400 (°C)/–300 to 700 (°F)
			10	–199.9 to 400.0 (°C)/–199.9 to 700.0 (°F)
		E	11	–200 to 600 (°C)/–300 to 1,100 (°F)
		L	12	–100 to 850 (°C)/–100 to 1,500 (°F)
		U	13	–200 to 400 (°C)/–300 to 700 (°F)
			14	–199.9 to 400.0 (°C)/–199.9 to 700.0 (°F)
		N	15	–200 to 1,300 (°C)/–300 to 2,300 (°F)
		R	16	0 to 1,700 (°C)/0 to 3,000 (°F)
		S	17	0 to 1,700 (°C)/0 to 3,000 (°F)
	B	18	100 to 1,800 (°C)/300 to 3,200 (°F)	
	Infrared temperature sensor ES1B	10 to 70°C	19	0 to 90 (°C)/0 to 190 (°F)
		60 to 120°C	20	0 to 120 (°C)/0 to 240 (°F)
		115 to 165°C	21	0 to 165 (°C)/0 to 320 (°F)
		140 to 260°C	22	0 to 260 (°C)/0 to 500 (°F)
	Analog input	0 to 50 mV	23	Either of the following ranges, by scaling: –1,999 to 9,999 –199.9 to 999.9
	Thermocouple	W	24	0 to 2,300 (°C)/0 to 3,200 (°F)
PLII		25	0 to 1,300 (°C)/0 to 2,300 (°F)	

- The default is 5.
- If a platinum resistance thermometer is mistakenly connected while a setting for other than a platinum resistance thermometer is in effect, S.ERR will be displayed. To clear the S.ERR display, check the wiring and then turn the power OFF and back ON. Make sure that the setting of the input type parameter agrees with the sensor that is connected.

	Input type	Specifications	Set value	Input temperature setting range
Models with analog input	Current input	4 to 20 mA	0	Either of the following ranges, by scaling: –1,999 to 9,999 –199.9 to 999.9 –19.99 to 99.99 –1.999 to 9.999
		0 to 20 mA	1	
	Voltage input	1 to 5 V	2	
		0 to 5 V	3	
		0 to 10 V	4	

- The default is 0.

3-3 Selecting the Temperature Unit

3-3-1 Temperature Unit

- Either °C or °F can be selected as the temperature unit.
- Set the temperature unit in the Temperature Unit parameter of the initial setting level. The default is $^{\circ}\text{C}$.

Operating Procedure

The following example shows how to select °C as the temperature unit.

Operation Level

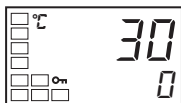

1. Press the \square Key for at least three seconds to move from the operation level to the initial setting level.

Initial Setting Level

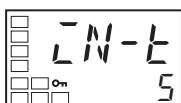

Input Type

2. Select the Temperature Unit parameter by pressing the \square Key. Press the \wedge or \vee Key to select either °C or °F.
 $^{\circ}\text{C}$
 $^{\circ}\text{F}$

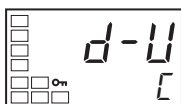

Temperature Unit

3. To return to the operation level, press the \square Key for at least one second.

3-4 Selecting PID Control or ON/OFF Control

Two control methods are supported: 2-PID control and ON/OFF control. Switching between 2-PID control and ON/OFF control is executed by means of the PID ON/OFF parameter in the initial setting level. When this parameter is set to $P\bar{L}d$, 2-PID control is selected, and when set to $\bar{a}N\bar{o}F$, ON/OFF control, is selected. The default is $\bar{a}N\bar{o}F$.

2-PID Control

PID control is set by AT (auto-tuning), ST (self-tuning), or manual setting.

For PID control, set the PID constants in the Proportional Band (P), Integral Time (I), and Derivative Time (D) parameters.

ON/OFF Control

In ON/OFF control, the control output is turned ON when the process value is lower than the current set point, and the control output is turned OFF when the process value is higher than the current set point (reverse operation).

3-5 Setting Output Specifications

3-5-1 Control Periods



Control Period (Heating)



Control Period (Cooling)

- Set the output periods (control periods). Though a shorter period provides better control performance, it is recommended that the control period be set to 20 seconds or longer for a relay output to preserve the service life of the relay. After the settings have been made in the initial setup, readjust the control period, as required, by means such as trial operation.
- Set the control periods in the Control Period (Heating) and Control Period (Cooling) parameters in the initial setting level. The default is 20 seconds.
- The Control Period (Cooling) parameter is used only for heating/cooling control.
- When control output 1 is used as a current output, Control Period (Heating) cannot be used.



Direct/Reverse Operation

5. Select the Direct/Reverse Operation parameter by pressing the Key. The default is $\bar{a}R-R$ (reverse operation). To select $\bar{a}R-d$ (direct operation), press the Key.

Operation Level

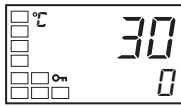

PV/SP

6. To return to the operation level, press the Key for at least one second.



Move to Advanced Function Setting Level

7. Select the Move to Advanced Function Setting Level parameter by pressing the Key.

3-5-3 Assigned Output Functions

- Function assignments can be changed by changing the settings for control and auxiliary output assignments.
- The default function assignments for each output are shown below.

Parameter name	Symbol	Initial status
Control Output 1 Assignment	$\bar{a}Ut 1$	Control output (heating)
Control Output 2 Assignment	$\bar{a}Ut 2$	Not assigned.
Auxiliary Output 1 Assignment	$Sub 1$	Alarm 1
Auxiliary Output 2 Assignment	$Sub 2$	Alarm 2
Auxiliary Output 3 Assignment (E5AN/EN only)	$Sub 3$	Alarm 3

- Refer to pages 240 to 242 for the functions that can be assigned to the outputs.
- Each output is automatically initialized as shown below by changing the control mode.

Example: E5CN

Parameter name	Symbol	Without control output 2		With control output 2	
		Standard	Heating/cooling	Standard	Heating/cooling
Control Output 1 Assignment	$\bar{a}Ut 1$	Control output (heating)	Control output (heating)	Control output (heating)	Control output (heating)
Control Output 2 Assignment	$\bar{a}Ut 2$	Not assigned. (See note 1.)	Not assigned. (See note 1.)	Not assigned.	Control output (cooling)
Auxiliary Output 1 Assignment	$Sub 1$	Alarm 1 (See note 2.)	Alarm 1 (See note 2.)	Alarm 1 (See note 2.)	Alarm 1 (See note 2.)
Auxiliary Output 2 Assignment	$Sub 2$	Alarm 2 (See note 3.)	Control output (cooling) (See note 3.)	Alarm 2	Alarm 2

Example: E5GN

Parameter name	Symbol	Standard	Heating/cooling
Control Output 1 Assignment	$\bar{a}Ut 1$	Control output (heating)	Control output (heating)
Auxiliary Output 1 Assignment	$Sub 1$	Alarm 1 (See note 2.)	Control output (cooling)
Auxiliary Output 2 Assignment	$Sub 2$	Alarm 2	Alarm 2

- Note**
- (1) There is no control output 2 and no parameter assignment is displayed for that output.
 - (2) The Auxiliary Output 1 Assignment parameter becomes the program end output unless the Program Pattern parameter is set to OFF.
 - (3) For the E5AN/EN, the Auxiliary Output 3 Assignment parameter is set as the control output for cooling. (The Auxiliary Output 2 Assignment parameter is set for alarm 2).

■ **Alarms**

It will be specified in this section when an alarm must be assigned, i.e., when an alarm must be set for the Control Output 1 or 2 Assignment parameters, or for the Auxiliary Output 1 to 3 Assignment parameters. For example, if alarm 1 is set for the Control Output 1 Assignment parameter, then alarm 1 has been assigned.

Assigning a work bit to either control output 1 or 2 or to auxiliary output 1 to 3 is also considered to be the same as assigning an alarm. For example, if work bit 1 is set for the Auxiliary Output 1 Assignment parameter, then alarms 1 to 3 have been assigned.

Operating Procedure

This procedure sets the following control and auxiliary output assignments.
 Control output 1: Control output (heating); Control output 2: Control output (cooling); Auxiliary output 1: Alarm 1; Auxiliary output 2: Alarm 2

Operation Level



1. Press the Key for at least three seconds to move from the operation level to the initial setting level.

Initial Setting Level

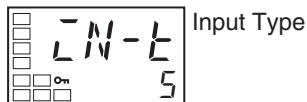

2. Select the Standard or Heating/Cooling parameter by pressing the Key.

Initial Setting Level



3. Press the Key to set the parameter to H-C.

Note The following output assignments do not need to be set because they are set automatically by changing the control mode, but they are shown here as a reference for checking the assignments for each output.

Initial Setting Level

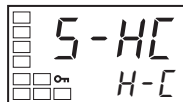

4. Select the Move to Advanced Function Setting Level parameter by pressing the Key. (For details on moving between levels, refer to 4-8 Moving to the Advanced Function Setting Level.)

Advanced Function Setting Level

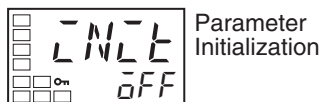

5. Press the Key to enter the password ("169"), and move from the initial setting level to the advanced function setting level.

Advanced Function Setting Level



Control Output 1 Assignment

6. Select the Control Output 1 Assignment parameter by pressing the Key.

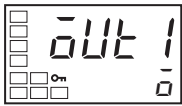

7. Press the or Key to set \bar{a} . (The default is \bar{a} .)

Advanced Function Setting Level

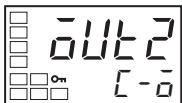

Control Output 2 Assignment

8. Select the Control Output 2 Assignment parameter by pressing the Key.



9. Press the or Key to set $L-\bar{a}$. (When $H-L$ is selected for the Standard or Heating/Cooling parameter, the setting will be $L-\bar{a}$.)

Advanced Function Setting Level

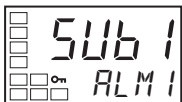

Auxiliary Output 1 Assignment

10. Select the Auxiliary Output 1 Assignment parameter by pressing the Key.

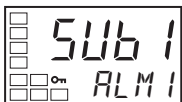

11. Press the or Key to set $ALM 1$. (The default is $ALM 1$.)

Advanced Function Setting Level

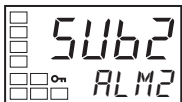

Auxiliary Output 2 Assignment

12. Select the Auxiliary Output 2 Assignment parameter by pressing the Key.

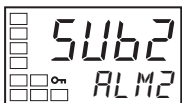

13. Press the or Key to set $ALM 2$. (The default is $ALM 2$.)

Initial Setting Level

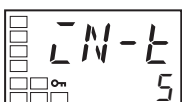

Input Type

14. Press the Key for at least one second to move from the advanced function setting level to the initial setting level.

Operation Level

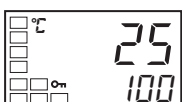

PV/SP

15. Press the Key for at least one second to move from the initial setting level to the operation level.

Auxiliary Output Opening or Closing in Alarm

- When “close in alarm” is set, the status of the auxiliary output is output unchanged. When “open in alarm” is set, the status of the auxiliary output function is reversed before being output.
- Each auxiliary output can be set independently.
- These settings are made in the Auxiliary Output 1 to 3 Open in Alarm parameters (advanced function setting level).
- The default is $N-\bar{a}$: Close in Alarm.

- When “open in alarm” is set for the alarm 1 output, the open in alarm status is also applied to heater burnout, HS alarm, heater overcurrent, and input error outputs.

	Auxiliary output functions 1 to 3	Auxiliary output	Indicators (SUB1 to SUB3)
Close in Alarm	ON	ON	Lit
	OFF	OFF	Not lit
Open in Alarm	ON	OFF	Lit
	OFF	ON	Not lit

- The alarm output will turn OFF (i.e., the relay contacts will open) when power is interrupted and for about two seconds after the power is turned ON regardless of the setting of the Auxiliary Output 1 to 3 Open in Alarm parameter.

3-6 Setting the Set Point (SP)

Operation Level

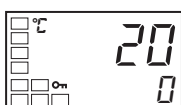

The operation level is displayed when the power is turned ON. The process value (PV) is at the top of the display, and the set point (SP) is at the bottom.

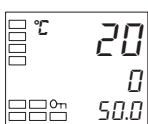

Operation Level



For Controllers that support a No. 3 display (E5AN/E5EN), the contents set in the PV/SP Display Screen Selection parameter (advanced function setting level) are displayed below the PV and SP.

The MV is displayed as the default. For details, refer to 3-11 Setting the No. 3 Display.

3-6-1 Changing the SP

- The set point cannot be changed when the Operation/Adjustment Protect parameter is set to 3. For details, refer to 4-9 Using the Key Protect Level.
- To change the set point, press the  or  Key in the Process Value/Set Point parameter (in the operation level), and set the desired set value. The new set point is selected two seconds after you have specified the new value.
- Multi-SP is used to switch between two or four set points. For details, refer to 4-5 Using Event Inputs for details.

Operating Procedure

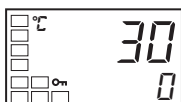

In this example, the set point is changed from 0°C to 200°C.

Operation Level

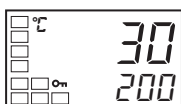

- Normally, the Process Value/Set Point parameter is displayed. The set point is 0°C.



- Use the  and  Keys to set the set point to 200°C.

3-7 Using ON/OFF Control

In ON/OFF control, the control output turns OFF when the temperature being controlled reaches the preset set point. When the manipulated variable turns OFF, the temperature begins to fall and the control turns ON again. This operation is repeated over a certain temperature range. At this time, how much the temperature must fall before control turns ON again is determined by the Hysteresis (Heating) parameter. Also, what direction the manipulated variable must be adjusted in response to an increase or decrease in the process value is determined by the Direct/Reverse Operation parameter.

3-7-1 ON/OFF Control

- Switching between 2-PID control and ON/OFF control is performed using the PID ON/OFF parameter in the initial setting level. When this parameter is set to PID , 2-PID control is selected, and when it is set to ON/OFF , ON/OFF control is selected. The default is ON/OFF .

Hysteresis

- With ON/OFF control, hysteresis is used to stabilize operation when switching between ON and OFF. The control output (heating) and control output (cooling) functions are set in the Hysteresis (Heating) and Hysteresis (Cooling) parameters, respectively.
- In standard control (heating or cooling control), the setting of the Hysteresis (Heating) parameter in the adjustment level is used as the hysteresis regardless of whether the control type is heating control or cooling control.

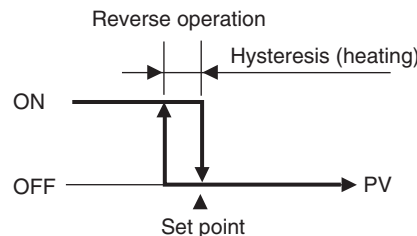

Three-position Control

- In heating/cooling control, a dead band (an area where both control outputs are 0) can be set to either the heating or cooling side. This makes it possible to use 3-position control.

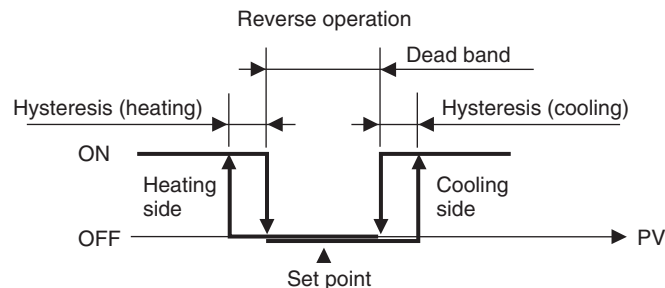

Parameters

Symbol	Parameter: level	Application
S-HL	Standard or Heating/Cooling: Initial setting level	Specifying control method
CNEL	PID ON/OFF: Initial setting level	Specifying control method
REV	Direct/Reverse Operation: Initial setting level	Specifying control method
C-db	Dead Band: Adjustment level	Heating/cooling control
HYS	Hysteresis (Heating): Adjustment level	ON/OFF control
CHYS	Hysteresis (Cooling): Adjustment level	ON/OFF control

3-7-2 Settings

To execute ON/OFF control, set the Set Point, PID ON/OFF, and Hysteresis parameters.

Setting the PID ON/OFF Parameter

Operating Procedure

Confirm that the PID ON/OFF parameter is set to $\bar{a}N\bar{a}F$ in the initial setting level.

Operation Level



1. Press the \square Key for at least three seconds to move from the operation level to the initial setting level.

Initial Setting Level

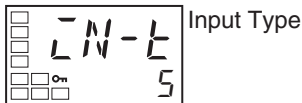

2. The Input Type parameter is displayed in the initial setting level.



3. Select the PID ON/OFF parameter by pressing the \square Key.
4. Check that the set value is $\bar{a}N\bar{a}F$ (i.e., the default).
5. To return to the operation level, press the \square Key for at least one second. Next, set the set point value.

Setting the SP

Operating Procedure

In this example, the set point is set to 200. The set value (i.e., the SP) is shown at the bottom of the display.

Operation Level



1. Select the Process Value/Set Point parameter in the operation level.

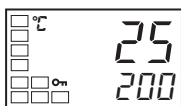

2. Use the \triangle and ∇ Keys to set the SP. (In this example, it is set to 200.) The new set value can be saved by pressing the \square Key, or it will go into effect after two seconds have elapsed.

Next, set the hysteresis.

Setting the Hysteresis

Operating Procedure

Set the hysteresis to 2.0°C.

Operation Level



1. Press the Key to move from the operation level to the adjustment level.

Adjustment Level

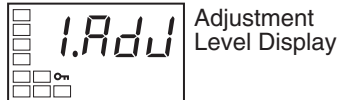

2. The Adjustment Level Display parameter will be displayed in the adjustment level.

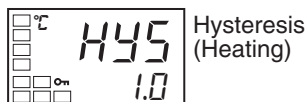

3. Select the Hysteresis (Heating) parameter by pressing the Key.

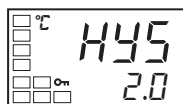

4. Press the and Keys to set the hysteresis (2.0 in this example). Either press the Key or wait for at least two seconds after setting the hysteresis value to confirm the setting.

5. To return to the operation level, press the Key.

3-8 Determining PID Constants (AT, ST, Manual Setup)

3-8-1 AT (Auto-tuning)



- When AT is executed, the optimum PID constants for the set point at that time are set automatically. A method (called the limit cycle method) for forcibly changing the manipulated variable and finding the characteristics of the control object is employed.
- Either 40% AT or 100% AT can be selected depending on the width of MV variation in the limit cycle. In the AT Execute/Cancel parameter, specify $AT-2$ (100% AT) or $AT-1$ (40% AT). To cancel AT, specify OFF (AT cancel).
- Only 100% AT can be executed for heating and cooling control.
- AT cannot be executed when control has stopped or during ON/OFF control.
- The results of AT are reflected in the Proportional Band (P), Integral Time (I), and Derivative Time (D) parameters in the adjustment level.

Adjustment Level

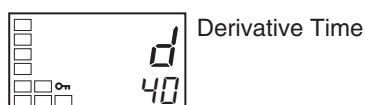
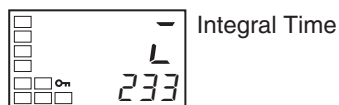

AT Operations

AT is started when either $AL-2$ (100% AT) or $AL-1$ (40% AT) is specified for the AT Execute/Cancel parameter. During execution, the AT Execute/Cancel parameter on the No. 1 display flashes. When AT ends, the AT Execute/Cancel parameter turns OFF, and the No. 1 display stops flashing.

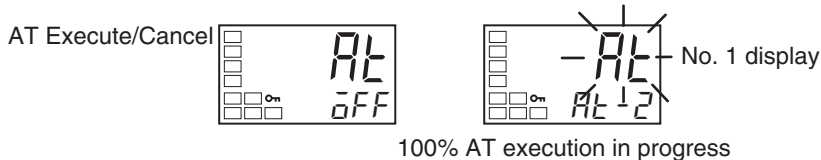

If you move to the operation level during AT execution, the No. 2 display flashes to indicate that AT is being executed.

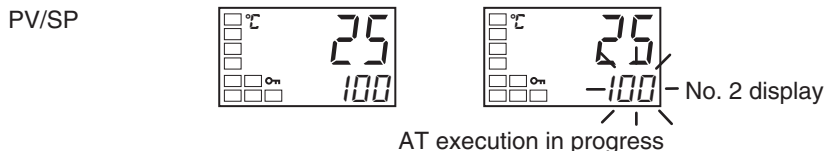

Only the Communications Writing, RUN/STOP, AT Execution/Cancel, and Program Start parameters can be changed during AT execution. Other parameters cannot be changed.

AT Calculated Gain

The AT Calculated Gain parameter sets the gain for when PID values are calculated using AT. When emphasizing response, decrease the set value. When emphasizing stability, increase the set value.

AT Hysteresis

The AT Hysteresis parameter sets the hysteresis when switching ON and OFF for the limit cycle operation during auto-tuning.

Limit Cycle MV Amplitude

The Limit Cycle MV Amplitude parameter sets the MV amplitude for limit cycle operation during auto-tuning.

Note This setting is disabled for 100% AT.

■ **40% AT**

The width of MV variation in the limit cycle can be changed in the Limit Cycle MV Amplitude parameter, but the AT execution time may be longer than for 100% AT. The limit cycle timing varies according to whether the deviation (DV) at the start of auto-tuning execution is less than 10% FS.

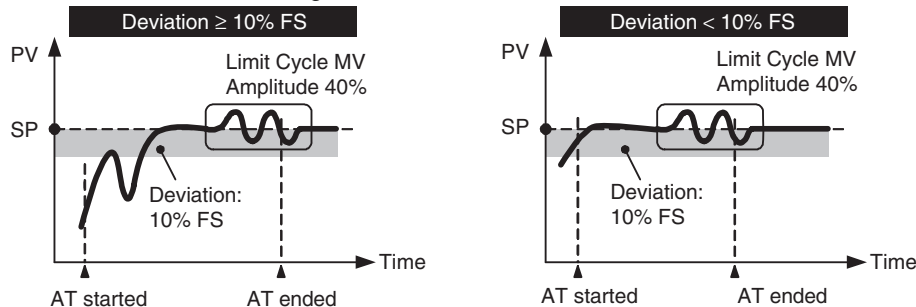

■ 100% AT

Operation will be as shown in the following diagram, regardless of the deviation (DV) at the start of AT execution. To shorten the AT execution time, select 100% AT.

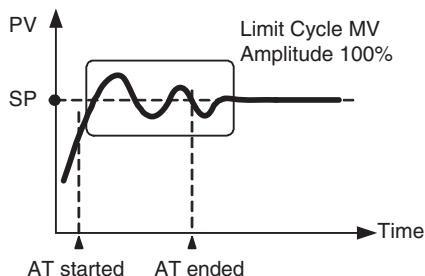

Note The Limit Cycle MV Amplitude parameter is disabled.

Operating Procedure

This procedure executes 40%AT.

Adjustment Level

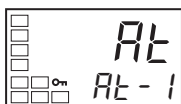
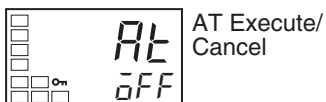

Operation Level

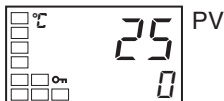

1. Press the Key to move from the operation level to the adjustment level.
2. Press the Key to select *At - 1*. The No. 1 display for AT Execute/Cancel will flash during AT execution.
3. *OFF* will be displayed when AT ends.
4. To return to the operation level, press the Key.

3-8-2 ST (Self-tuning)



ST (self-tuning) is a function that finds PID constants by using step response tuning (SRT) when Controller operation begins or when the set point is changed.

Once the PID constants have been calculated, ST is not executed when the next control operation is started as long as the set point remains unchanged.

ST (self-tuning) is enabled when the ST parameter is set to ON in the initial setting level.

When the ST function is in operation, be sure to turn the power supply of the load connected to the control output ON simultaneously with or before starting Controller operation.

When executing self-tuning, turn ON power for the load (e.g., heater) at the same time as or before supplying power to the Digital Temperature Controller. If power is turned ON for the Digital Temperature Controller before turning ON power for the load, self-tuning will not be performed properly and optimum control will not be achieved.

Note PID Constants
 When control characteristics are already known, PID constants can be set directly to adjust control. PID constants are set in the Proportional Band (P), Integral Time (I), and Derivative Time (D) parameters in the adjustment level.

Operating Procedure

This procedure executes self-tuning (ST).

Initial Setting Level

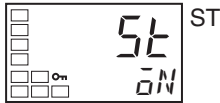
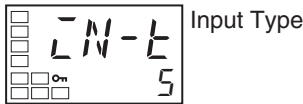

Operation Level



1. Press the Key for at least three seconds to move from the operation level to the initial setting level.
2. Select the ST parameter by pressing the Key.
3. Press the Key to select *ON*. ON is the default.
4. To return to the operation level, press the Key for at least one second. The temperature display flashes during self-tuning (ST) execution.

Startup Conditions

Self-tuning by step response tuning (SRT) is started when the following conditions are met after program execution is started and the set point is changed.

At start of operation	When set point is changed
<ol style="list-style-type: none"> 1. The set point at the start of operation differs from the set point when the previous SRT was executed. (See note 1.) 2. The difference between the temperature at the start of operation and the set point is greater both of the following: (Present proportional band × 1.27 + 4°C) and the ST stable range. 3. The temperature at the start of operation is lower than the set point during reverse operation, and is larger than the set point during direct operation. 4. There is no reset from input errors. 	<ol style="list-style-type: none"> 1. The new set point differs from the set point used when the previous SRT was executed. (See note 1.) 2. The set point change width is greater both of the following: (Present proportional band × 1.27 + 4°C) and the ST stable range. 3. During reverse operation, the new set point is larger than the set point before the change; and during direct operation, the new set point is smaller than the set point before the change. 4. The temperature is stable. (See note 2.) (Equilibrium with the output amount at 0% when the power is turned ON is also all right.) (See note 3.)

- Note**
- (1) The previous SRT-implemented set point is the set point that was used for calculating the PID constants for the previous SRT.
 - (2) In this state, the measurement point is within the ST stable range.
 - (3) In this state, the change width of the PV every 60 seconds is within the ST stable range or less.

In the following instances, PID constants are not changed by self-tuning (ST) for the present set point.

- 1,2,3...**
1. When the PID constants have been changed manually with ST set to ON.
 2. When auto-tuning (AT) has been executed.

ST Stable Range

Operating Procedure

The ST stable range determines the condition under which ST (self-tuning) functions.

This procedure sets the ST stable range to 20.0°C.

Advanced Function Setting Level

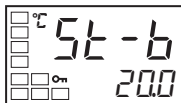
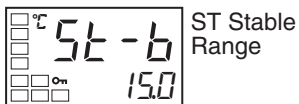

1. Select the ST Stable Range parameter by pressing the Key in the advanced function setting level.

2. Use the Key to set the parameter to 20.0°C.

3-8-3 RT (Robust Tuning)



- When AT or ST is executed with RT selected, PID constants are automatically set that make it hard for control performance to degenerate even when the characteristics of the controlled object are changed.
- RT can be set in the advanced function setting level when PID control has been set.
- The RT mode cannot be selected while an analog input is set.
- Selecting the RT mode in the following cases will help to prevent hunting from occurring.
 - When the set temperature is not constant and is changed in a wide range
 - When there are large variations in ambient temperatures due to factors such as seasonal changes or differences between day and night temperatures
 - When there are large variations in ambient wind conditions and air flow
 - When heater characteristics change depending on the temperature
 - When an actuator with disproportional I/O, such as a phase-control-type power regulator, is used
 - When a rapidly heating heater is used
 - When the control object or sensor has much loss time
 - When hunting occurs in normal mode for any reason
 - PID constants are initialized to the factory settings by switching to RT mode.
 - When the RT mode is selected, the derivative time setting unit becomes the second.

RT Features

- Even when hunting occurs for PID constants when AT or ST is executed in normal mode, it is less likely to occur when AT or ST is executed in RT mode.

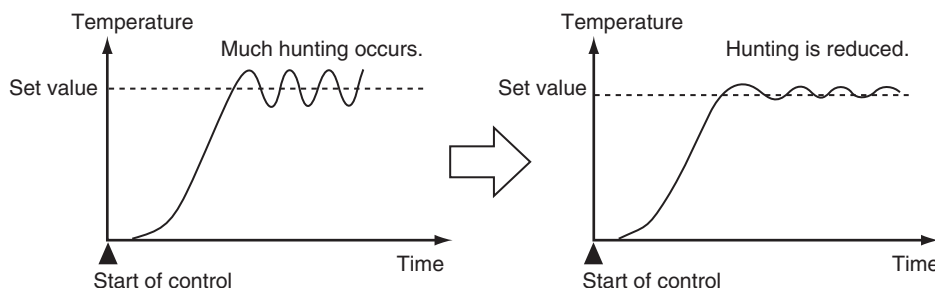

- When the temperature (PV) falls short of the set point for the PID constants when using AT or ST in normal mode, executing AT or ST in RT mode tends to improve performance.

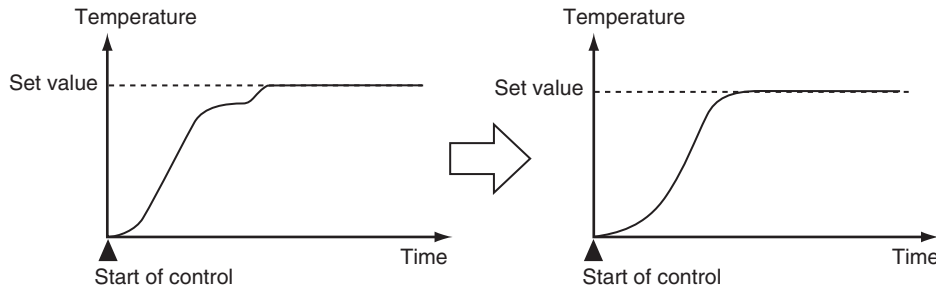

- When the manipulated variable (MV) is saturated, the amount of overshooting may be somewhat higher in comparison to PID control based on AT or ST in normal mode.

Operating Procedure

This procedure selects RT mode.

Operation Level



1. Press the Key for at least three seconds to move from the operation level to the initial setting level.

Initial Setting Level

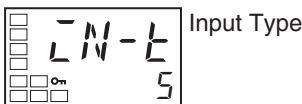

2. Select the Move to Advanced Function Setting Level parameter by pressing the Key.

Initial Setting Level



3. Use the Key to enter “-169” (the password).

Advanced Function Setting Level

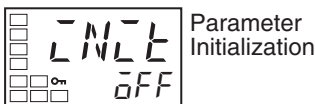

It is possible to move to the advanced function setting level by pressing the Key or leaving the setting for at least two seconds.

Advanced Function Setting Level

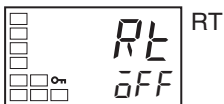

4. Press the Key to select RT.

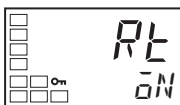

5. Press the Key to select ON. OFF is the default.

Initial Setting Level

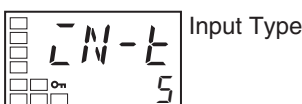

6. To return to the initial setting level, press the Key for at least one second.

Operation Level



7. To return to the operation level, press the Key for at least one second.

3-8-4 Manual Setup

Individual PID constants can be manually set in the Proportional Band, Integral Time, and Derivative Time parameters in the adjustment level.

Operating Procedure

In this example, the Proportional Band parameter is set to 10.0, the Integral Time parameter to 250, and the Derivative Time parameter to 45.

Adjustment Level

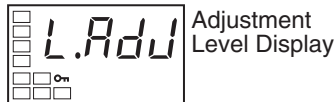

1. Press the Key to move from the operation level to the adjustment level.

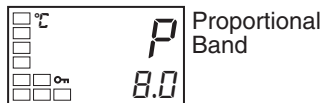

2. Press the Key to select the proportional band parameter.

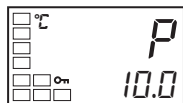

3. Use the and Keys to set 10.0.

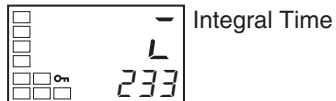

4. Press the Key to select the Integral Time parameter.

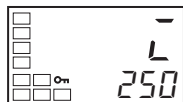

5. Use the and Keys to set 250.



6. Select the Derivative Time operation by pressing the Key.

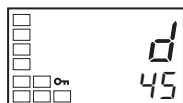

7. Use the and Keys to set 45.

8. To return to the operation level, press the Key.

Note Proportional Action

When PID constants I (integral time) and D (derivative time) are set to 0, control is executed according to proportional action. As the default, the center value of the proportional band becomes the set point.
 Related parameter: Manual reset value (adjustment level)

When P (Proportional Band) Is Adjusted

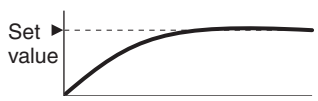
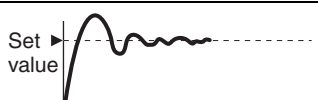
Increased		The curve rises gradually, and a long stabilization time is created, but overshooting is prevented.
Decreased		Overshooting and hunting occur, but the set value is quickly reached and the temperature stabilizes.

When I (Integral Time) Is Adjusted

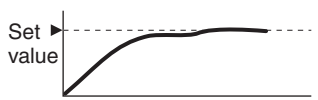
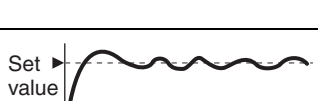
Increased		It takes a long time to reach the set point. It takes time to achieve a stable state, but overshooting, undershooting, and hunting are reduced.
Decreased		Overshooting and undershooting occur. Hunting occurs. The Controller starts up faster.

When D (Derivative Time) Is Adjusted

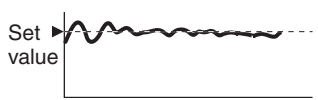
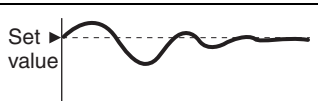
Increased		Overshooting, undershooting, and stabilization times are reduced, but fine hunting occurs on changes in the curve itself.
Decreased		Overshooting and undershooting increase, and it takes time to return to the set point.

3-9 Alarm Outputs

- Alarms can be used by the E5CN-□2□□□ (2 auxiliary outputs), E5AN/E5EN-□1□□□ (1 auxiliary output), E5AN/E5EN-□3□□□ (3 auxiliary outputs), the E5CN-□1□□□U (1 auxiliary output), the E5CN-□2□□□U (2 auxiliary outputs), E5GN-□1□□□ (1 auxiliary output), and E5GN-□2□□□ (2 auxiliary outputs).

Alarms can also be used by setting the Control Output 1 Assignment or Control Output 2 Assignment parameter to any of the alarms from alarm 1 to 3. The alarm output condition is determined by a combination of the alarm type, alarm value, alarm hysteresis, and the standby sequence. For details, refer to 4-2 Alarm Hysteresis.

- This section describes the Alarm Type, Alarm Value, Upper-limit Alarm and Lower-limit Alarm parameters.

3-9-1 Alarm Types

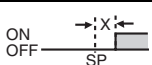
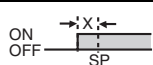
Set value	Alarm type	Alarm output operation		Description of function
		When alarm value X is positive	When alarm value X is negative	
0	Alarm function OFF	Output OFF		No alarm
1 (See note 1.)	Upper- and lower-limit		See note 2.	Set the deviation in the set point by setting the alarm upper limit (H) and alarm lower limit (L).
2	Upper-limit			Set the upward deviation in the set point by setting the alarm value (X).

Set value	Alarm type	Alarm output operation		Description of function
		When alarm value X is positive	When alarm value X is negative	
3	Lower-limit			Set the downward deviation in the set point by setting the alarm value (X).
4 (See note 1.)	Upper- and lower-limit range		See note 3.	Set the deviation in the set point by setting the alarm upper limit (H) and alarm lower limit (L).
5 (See note 1.)	Upper- and lower-limit with standby sequence		See note 4.	A standby sequence is added to the upper- and lower-limit alarm (1). (See note 6.)
6	Upper-limit with standby sequence			A standby sequence is added to the upper-limit alarm (2). (See note 6.)
7	Lower-limit with standby sequence			A standby sequence is added to the lower-limit alarm (3). (See note 6.)
8	Absolute-value upper-limit			The alarm will turn ON if the process value is larger than the alarm value (X) regardless of the set point.
9	Absolute-value lower-limit			The alarm will turn ON if the process value is smaller than the alarm value (X) regardless of the set point.
10	Absolute-value upper-limit with standby sequence			A standby sequence is added to the absolute-value upper-limit alarm (8). (See note 6.)
11	Absolute-value lower-limit with standby sequence			A standby sequence is added to the absolute-value lower-limit alarm (9). (See note 6.)
12	LBA (alarm 1 type only)	---	---	Refer to page 118. (See note 7.)
13	PV change rate alarm	---	---	Refer to page 72. (See note 8.)

Note (1) With set values 1, 4, and 5, the upper- and lower-limit values can be set independently for each alarm type, and are expressed as “L” and “H.”

(2) Set value: 1 (Upper- and lower-limit alarm)

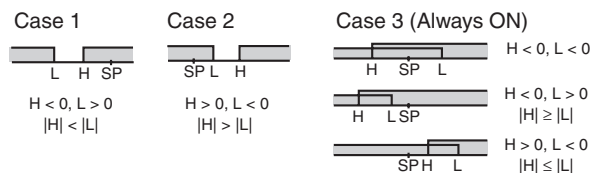

(3) Set value: 4 (Lower limit range)

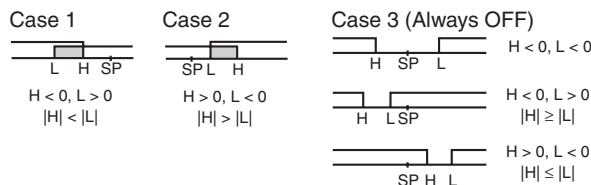

(4) Set value: 5 (Upper- and lower-limit with standby sequence)

- For the lower-limit alarms in cases 1 and 2 above, the alarm is always OFF if upper- and lower-limit hysteresis overlaps.
- In case 3, the alarm is always OFF.

- (5) Set value: 5 (Upper- and lower-limit with standby sequence)
 - The alarm is always OFF if upper- and lower-limit hysteresis overlaps.
- (6) Refer to 4-2-1 Standby Sequence for information on the operation of the standby sequence.
- (7) Refer to 4-12-1 Loop Burnout Alarm (LBA).
- (8) Refer to PV Change Rate Alarm on page 72.
 - Set the alarm type independently for each alarm in the Alarm 1 to 3 Type parameters in the initial setting level. The default is 2 (Upper-limit alarm).

3-9-2 Alarm Values

 Alarm Lower Limit Value





 Alarm Upper Limit Value





 Alarm Value



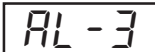

- Alarm values are indicated by “X” in the table on the previous page. When the upper and lower limits are set independently, “H” is displayed for upper limit values, and “L” is displayed for lower limit values.
- To set the alarm value upper and lower limits for deviation, set the upper and lower limits in each of the Alarm 1 to 3 Upper Limit, and Alarm 1 to 3 Lower Limit parameters in the operation level.

Operating Procedure

This procedure sets alarm 1 as an upper-limit alarm. The related parameters and settings are shown below. The alarm is output when the set point exceeds 10°C. (In this example, the temperature unit is °C.)

Alarm 1 type = 2 (Upper-limit alarm)

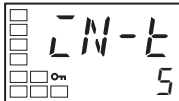

Alarm value 1= 10

Initial Setting Level

 Input Type

 Alarm 1 Type

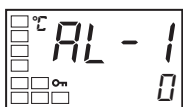

 PV/SP

1. Press the  Key for at least three seconds to move from the operation level to the initial setting level.
2. Select the Alarm 1 Type parameter by pressing the  Key. Confirm that the set value is 2. The default value is 2 (Upper-limit alarm).
3. To return to the operation level, press the  Key for at least one second.



Alarm Value 1



4. Select the Alarm Value 1 parameter by pressing the  Key.
5. Use the  Key to set the parameter to 10.

PV Change Rate Alarm

The change width can be found for PV input values in any set period. Differences with previous values in each set period are calculated, and an alarm is output if the result exceeds the alarm value. The PV rate of change calculation period can be set in units of 250 ms.

If a positive value is set for the alarm value, the PV will operate as a change rate alarm in the rising direction. If a negative value is set, the PV will operate as a change rate alarm in the falling direction.

Precaution

If a shorter PV rate of change calculation period is set, outputs set for the PV change rate alarm function may repeatedly turn ON and OFF for a short period of time. It is therefore recommended that the PV change rate alarm be used with the alarm latch turned ON.

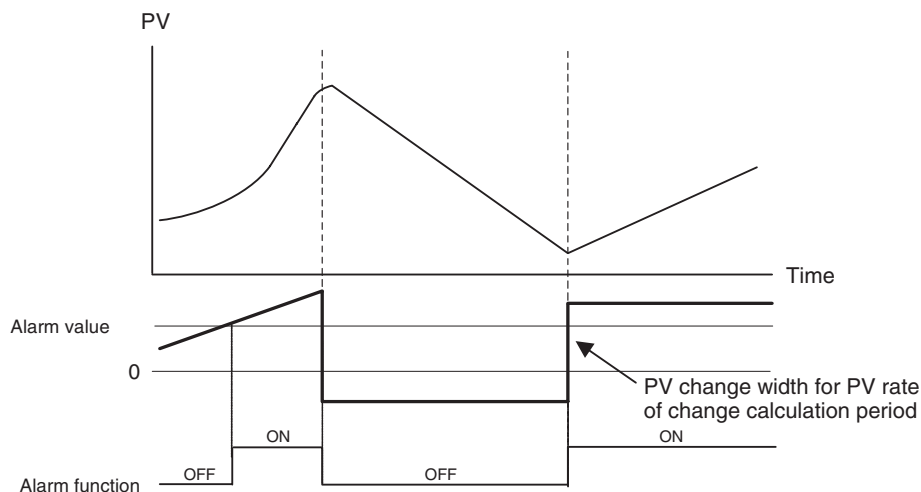

Parameter name	Setting range	Unit	Default
PV Rate of Change Calculation Period	1 to 999	Sampling cycle	4 (1 s)

3-10 Using Heater Burnout, Heater Short, and Heater Overcurrent Alarms

3-10-1 Heater Burnout, Heater Short, and Heater Overcurrent Alarm Operations

- Heater burnout detection and heater overcurrent detection are executed by measuring heater current while the control output (heating) is ON, and heater short detection is executed by measuring heater current while it is OFF. For details, refer to the following table. (Heater burnout detection, heater short detection, and heater overcurrent detection cannot be used with the control output for cooling.)

Control output (heating) status		Power to heater	HB alarm output	HS alarm output	Heater overcurrent alarm output
Control output (heating)	Operation indicator				
ON	Lit	Yes (Normal) (See note 1.)	OFF	---	---
		No (Heater burnout)	ON	---	---
OFF	Not lit	Yes (HS alarm)	---	ON	---
		No (Normal) (See note 2.)	---	OFF	---
ON	Lit	Normal	---	---	OFF
		Heater overcurrent status (See note 3.)	---	---	ON

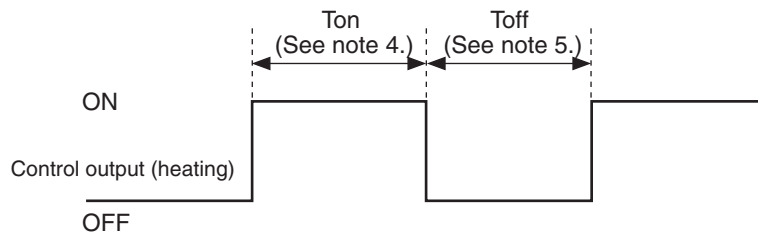

Note

- (1) In the above diagram, power is considered to be ON (normal) if the heater current is greater than the heater burnout detection current during the T_{on} interval. If the heater is burned out, the measured current decreases and falls below the heater burnout detection value. The output is then activated as the heater burnout alarm.
- (2) In the above diagram, power is considered to be OFF (normal) if the leakage current is less than the HS alarm current during the T_{off} interval. If the SSR output is short-circuited, the measured current increases beyond the HS alarm value. The output is then activated as the HS alarm.
- (3) In the above diagram, it is regarded as normal when the heater current is less than the heater overcurrent detection current during the T_{on} period. Current is increased when excessive current flows to the heater, causing the heater overcurrent detection value to be exceeded and an OC (heater overcurrent) alarm to be output.
- (4) Heater burnout and heater overcurrent are not detected if the control output (heating) ON time (T_{on}) is 100 ms or less.
- (5) HS alarms are not detected if the control output (heating) OFF time (T_{off}) is 100 ms or less.

- For Controllers with heater burnout, HS, and heater overcurrent alarms, an OR output is established between the ALM 1 function and the alarms. If the ALM1 function is to be used for the heater burnout, HS, and heater overcurrent alarms only, set 0 as the alarm 1 type (i.e., do not use ALM1).
- Turn the heater power ON simultaneously or before turning ON the E5□N power. If the heater power is turned ON after turning ON the E5AN power, the HB alarm will be activated.
- Control is continued even when the heater burnout, HS, or heater overcurrent alarm is active.
- The rated current value may sometimes differ slightly from the actual current flowing to the heater. Use the Heater Current 1 Value Monitor, Heater Current 2 Value Monitor, Leakage Current 1 Monitor, and Leakage Current 2 Monitor parameters to check the actual current being used.
- If there is little difference between the current in normal and abnormal states, detection may become unstable. To stabilize detection, set a current value difference of at least 1.0 A for heaters of less than 10.0 A, and at least 2.5 A for heaters of 10.0 A or more. If the heater current is too low, loop the load line several times through a CT, as shown in the diagram below. Looping it through once will double the detection current.



3-10-2 Installing Current Transformers (CT)

- This function can be used with E5□N models that have the HB alarm, HS alarm, and OC alarm. For the E5CN, connect the CT in advance to terminals 14 and 15 (CT1), or 13 and 15 (CT2). For the E5AN/E5EN, connect the CT in advance to terminals 14 and 15 (CT1) or 15 and 16 (CT2). For the E5GN, connect the CT in advance to terminals 7 and 8 (CT1). Then pass the heater power line through the CT's hole. For specifications, models and dimensions of current transformers that can be used with this Controller, refer to *Appendix Current Transformer (CT)* on page 279.

Single-phase Heaters

For single-phase heaters, install the CT in the position shown in the following diagram.

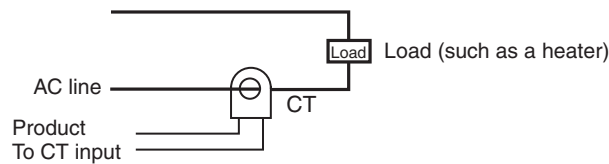

Three-phase Heaters (E5AN-□□HH□-N, E5EN-□□HH□-N, and E53-CN□□HHN2 (for E5CN) 3-phase Heater Detection Models)

When a 3-phase power supply is used, regardless of the types of connecting lines, two current transformers (CTs) are required to detect heater burnout, HS, and OC.

- 1,2,3... 1. Delta connecting lines: Refer to the following diagram for CT installation positions.

Note Heater voltage fluctuations are not considered here, so be take that into account when setting the detection current.

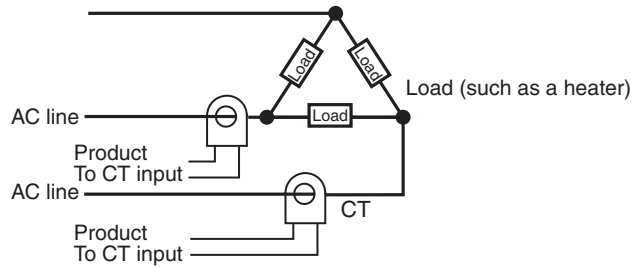

2. Star connecting lines: Refer to the following diagram for CT installation positions.

Note Heater voltage fluctuations are not considered here, so be take that into account when setting the detection current.

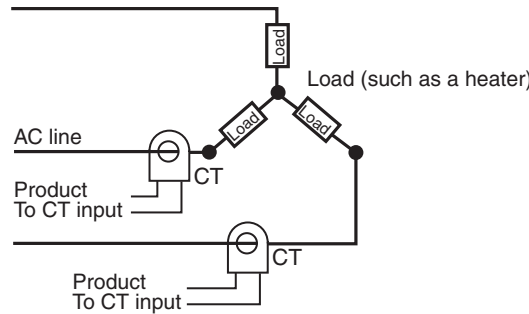

3. V connecting lines: Refer to the following diagram for CT installation positions.

Note Heater voltage fluctuations are not considered here, so be take that into account when setting the detection current.

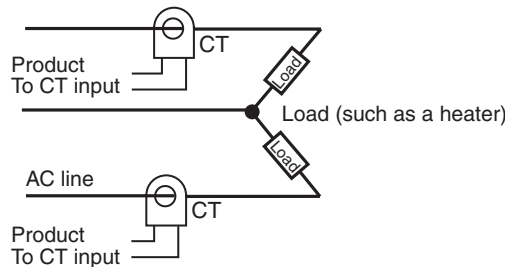

3-10-3 Calculating Detection Current Values

- Calculate the set value using the following equation:

$$\text{Heater Burnout Detection 1/2 set value} = \frac{\text{Normal current value} + \text{Burnout current value}}{2}$$

$$\text{HS Alarm 1/2 set value} = \frac{\text{Leakage current value (output OFF)} + \text{HS current value}}{2}$$

$$\text{Heater overcurrent 1/2 set value} = \frac{\text{Normal current value} + \text{Overcurrent value}}{2}$$

- To set the current for heater burnout when two or more heaters are connected through the CT, use the value from when the heater with the smallest current burns out. If all of the heaters have the same current, use the value from when any one of them burns out.

- Make sure that the following conditions are satisfied:
 Heater with a current of less than 10.0 A:
 (Current value at normal operation) – (Current value at heater burnout) ≥ 1 A
 When the difference is less than 1 A, detection is unstable.
 Heater with a current of 10.0 A or more:
 (Current value at normal operation) – (Current value at heater burnout) ≥ 2.5 A
 When the difference is less than 2.5 A, detection is unstable.
- The setting range is 0.1 to 49.9 A. Heater burnout, HS, and heater overcurrent are not detected when the set value is 0.0 or 50.0. When the set value is 0.0, the heater burnout alarm is always OFF, the HS alarm is always ON, and the heater overcurrent alarm is always ON. When the set value is 50.0, the heater burnout alarm is always ON, the HS alarm is always OFF, and the heater overcurrent alarm is always OFF.
- Set the total current value for normal heater operation to 50 A or less. When a current value of 55.0 A is exceeded, FFFF is displayed in the Heater Current 1 (or 2) Value Monitor and Leakage Current 1 (or 2) Monitor parameters.

3-10-4 Application Examples

Single-phase Heaters

Example: Using a 200-VAC, 1-kW Heater

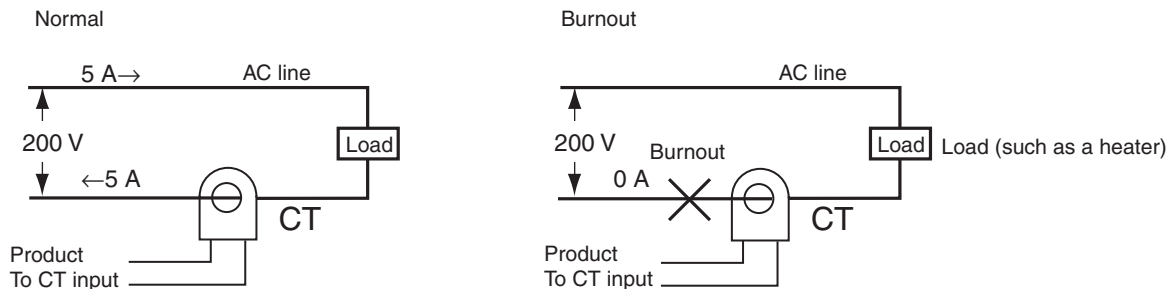

The heater power supply provides 5 A when the current is normal, and 0 A when there is a burnout, so the heater burnout detection current is calculated as follows:

$$\begin{aligned} \text{Heater burnout detection current} &= \frac{(\text{Normal current}) + (\text{Heater burnout current})}{2} \\ &= \frac{5 + 0}{2} = 2.5 \text{ [A]} \end{aligned}$$

Example: Using Three 200-VAC, 1-kW Heaters

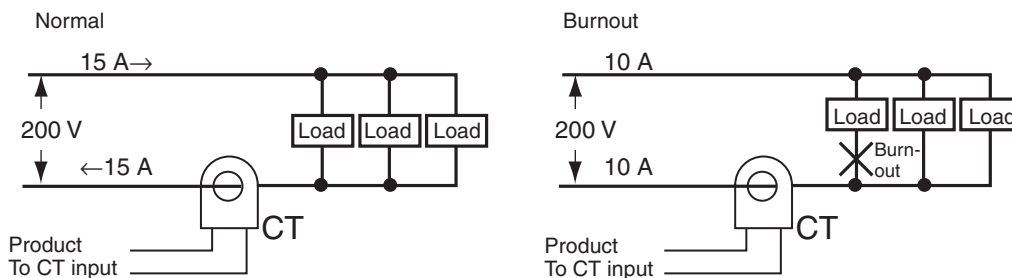

The heater power supply provides 15 A when the current is normal, and 10 A when there is a burnout, so the heater burnout detection current is calculated as follows:

$$\text{Heater burnout detection current} = \frac{(\text{Normal current}) + (\text{Heater burnout current})}{2}$$

$$= \frac{15 + 10}{2} = 12.5 \text{ [A]}$$

Three-phase Heaters

Delta Connecting Lines

Example: Using Three 200-VAC, 2-kW Heaters

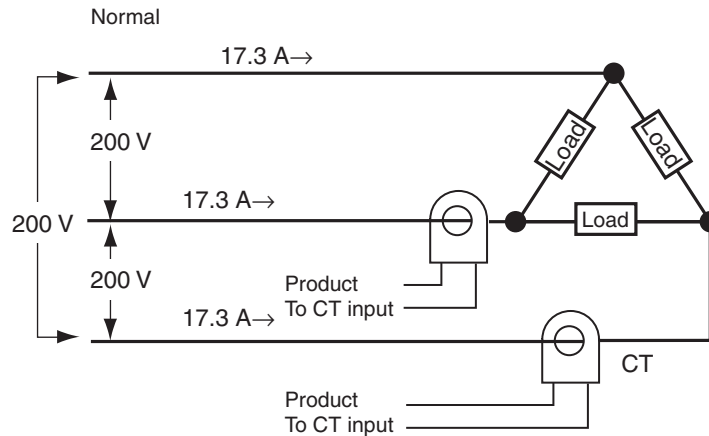

The current when each phase is normal is 17.3 A ($\approx \sqrt{3} \times 10 \text{ A}$).

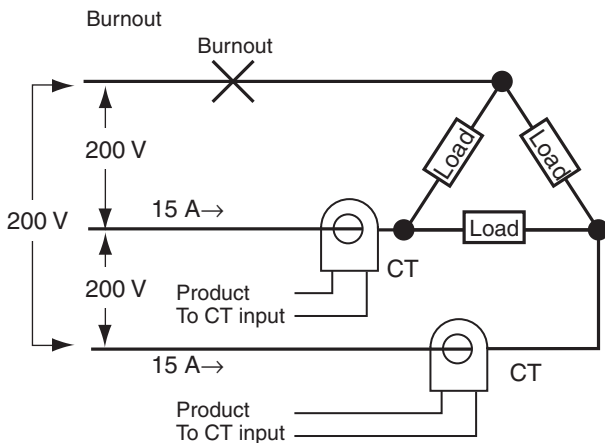

Current when there is a burnout = $10 \text{ A} \times \sqrt{3} \times (\sqrt{3}/2) = 15 \text{ A}$

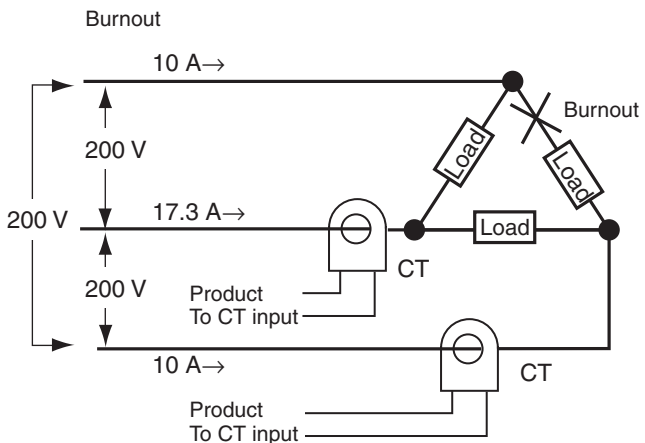

Current when there is a burnout = $10 \text{ A} \times \sqrt{3} \times (1/\sqrt{3}) = 10 \text{ A}$

The heater burnout current when there is a burnout at the load line is as follows:

$$(\text{Heater burnout detection current}) = (17.3 + 15) / 2 \approx 16.1 \text{ [A]}$$

The heater burnout current when there is a burnout at the load is as follows:

$$(\text{Heater burnout detection current}) = (17.3 + 10) / 2 \approx 13.65 \text{ [A]}$$

To enable detection in either case, use 16.1 A as the heater burnout detection current.

Star Connecting Lines

Example: Using Three 200-VAC, 2-kW Heaters

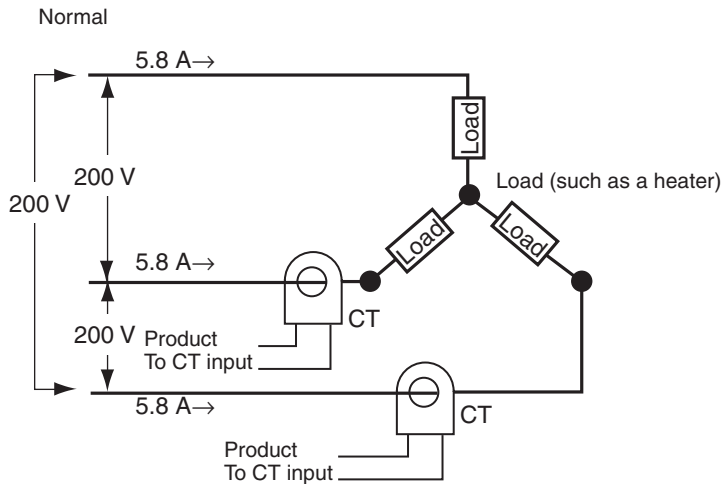

The current when each phase is normal is 5.8 A ($\approx 10 \text{ A} \times (1/\sqrt{3})$).

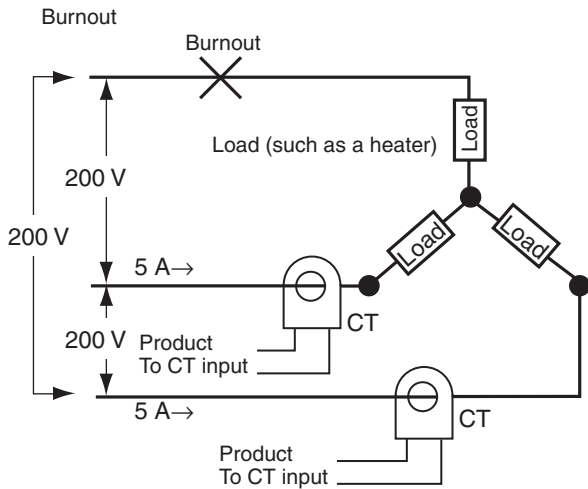

$$\text{Current when there is a burnout} = 10 \text{ A} \times (1/\sqrt{3}) \times (\sqrt{3}/2) = 5 \text{ A}$$

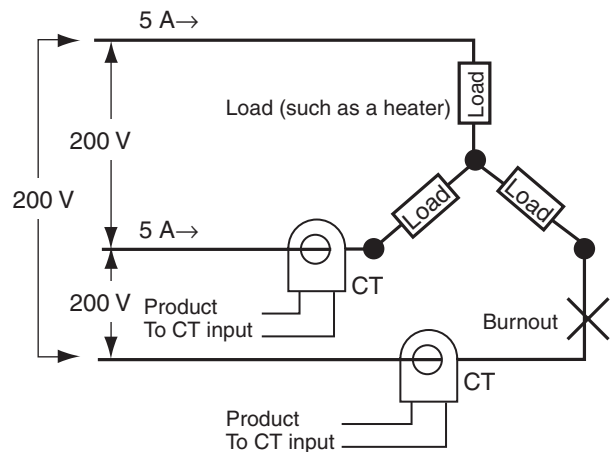

$$\text{Current when there is a burnout} = 10 \text{ A} \times (1/\sqrt{3}) \times (\sqrt{3}/2) = 5 \text{ A}$$

The heater burnout detection current for this connecting line is 5.4 A (= (5.8 + 5) / 2).

V Connecting Lines

Example: Using Two 200-VAC, 2-kW Heaters

Normal

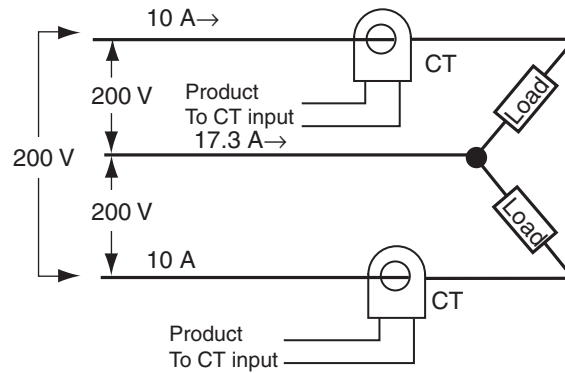

Burnout

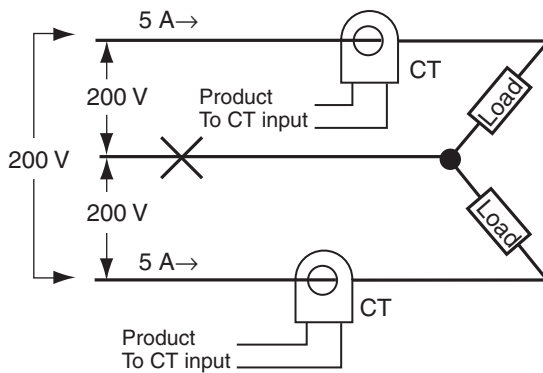

Current when there is a burnout = $10\text{ A} \times (1/2)$
= 5 A

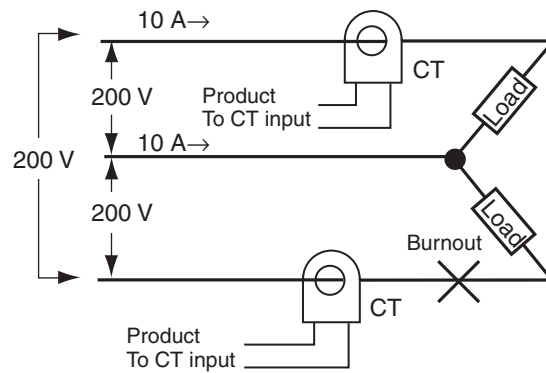

Current when there is a burnout = 0 A

The heater burnout current when there is a burnout at the common is as follows:

$$\text{Heater burnout detection current} = (10 + 5) / 2 \approx 7.5 \text{ [A]}$$

The heater burnout current when there is a burnout at the load is as follows:

$$\text{Heater burnout detection current} = (10 + 0) / 2 \approx 5 \text{ [A]}$$

To enable detection in either case, use 7.5 A as the heater burnout detection current.

3-10-5 Settings: HB Alarm



To activate the heater burnout alarm, set the HB ON/OFF parameter to ON in the advanced function setting level and set the Heater Burnout Detection 1 and Heater Burnout Detection 2 parameters in the adjustment level.

Operating Procedure

This procedure sets the Heater Burnout Detection 1 parameter to 2.5.

■ Moving to the Advanced Function Setting Level

The Heater Burnout Detection parameter setting is already ON by default, so set the Heater Burnout Detection 1 parameter.

1. Move to the advanced function setting level.
Press the  Key for at least three seconds to move from the operation level to the initial setting level.
2. Select Move to Advanced Function Setting Level by pressing the  Key. (For details on moving between levels, refer to 4-8 *Moving to the Advanced Function Setting Level*.)
3. Press the  Key to enter the password (-169), and move from the initial setting level to the advanced function setting level.

Operation Level



Initial Setting Level

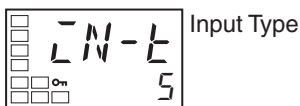

Initial Setting Level



Advanced Function Setting Level







The top parameter in the advanced function setting level is displayed.



4. Select the Heater Burnout Detection parameter by pressing the  Key. Check that this parameter is set to ON (the default). Next, set the Heater Burnout Detection 1 parameter.

■ Setting Heater Burnout Detection

5. Press the  Key for at least one second to move from the advanced function setting level to the initial setting level. Press the  key again for at least one second to move to the operation level.
6. Press the  Key for less than one second to move from the operation level to the adjustment level.
7. Select the Heater Current 1 Value Monitor parameter by pressing the  Key. Check the current value. Next, set the Heater Burnout Detection 1 parameter.
8. Select the Heater Burnout Detection 1 parameter by pressing the  Key. Refer to *Calculating Detection Current Values* on page 75 on when making the settings.

Operation Level



Adjustment Level





9. For this example, set 2.5. To return to the operation level, press the Key for less than one second.

3-10-6 Settings: Heater Short Alarm

To activate the HS alarm, set the HS Alarm Use parameter to ON in the advanced function setting level and set the HS Alarm 1 and HS Alarm 2 parameters in the adjustment level.

Operating Procedure

This procedure sets the HS Alarm 1 parameter to 2.5.

■ Moving to the Advanced Function Setting Level

The HS Alarm Use parameter setting is already ON by default, so set the HS Alarm 1 parameter.

Operation Level



1. Move to the advanced function setting level.
Press the Key for at least three seconds to move from the operation level to the initial setting level.

Initial Setting Level

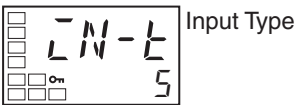

2. Select Move to Advanced Function Setting Level by pressing the Key. (For details on moving between levels, refer to 4-8 Moving to the Advanced Function Setting Level.)

Initial Setting Level



3. Press the Key to enter the password (-169), and move from the initial setting level to the advanced function setting level.

Advanced Function Setting Level

The top parameter in the advanced function setting level is displayed.

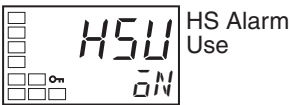

4. Select the HS Alarm Use parameter by pressing the Key. Check that this parameter is set to ON (the default). Next, set the HS Alarm 1 parameter.

■ HS Alarm Settings

Operation Level



5. Press the Key for at least one second to move from the advanced function setting level to the initial setting level. Press the key again for at least one second to move to the operation level.

Adjustment Level



6. Press the Key for less than one second to move from the operation level to the adjustment level.



7. Select the Leakage Current 1 Monitor parameter by pressing the Key. Check the current value. Next, set the HS Alarm 1 parameter.

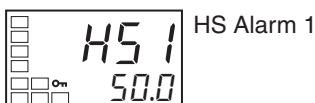

8. Select the HS Alarm 1 parameter by pressing the Key. Refer to *Calculating Detection Current Values* on page 75 when setting the values.

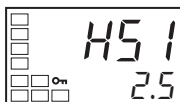

9. For this example, set 2.5. To return to the operation level, press the Key for less than one second.

3-10-7 Settings: Heater Overcurrent Alarm

To activate heater overcurrent alarm, set the Heater Overcurrent Use parameter to ON in the advanced function setting level and set the Heater Overcurrent Detection 1 and Heater Overcurrent Detection 2 parameters in the adjustment level.

Operating Procedure

This procedure sets the Heater Overcurrent Detection 1 parameter to 20.0.

■ Moving to the Advanced Function Setting Level

The default setting for the Heater Overcurrent Use parameter is ON, so set the Heater Overcurrent Detection 1 parameter.

Operation Level



1. Move to the advanced function setting level. Press the Key for at least three seconds to move from the operation level to the initial setting level.

Initial Setting Level

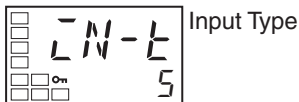

2. Press the Key to select the Move to Advanced Function Setting Level parameter. (For details on moving between levels, refer to *4-8 Moving to the Advanced Function Setting Level*.)

Initial Setting Level

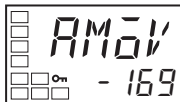

3. Press the Key to enter the password (-169), and move from the initial setting level to the advanced function setting level.

Advanced Function Setting Level

The top parameter in the advanced function setting level is displayed.

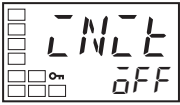

Move to the Advanced Function Setting Level



Heater Overcurrent Use

4. Press the Key to select the Heater Overcurrent Use parameter. Check that this parameter is set to ON (the default), and then set the Heater Overcurrent Detection 1 parameter.

■ Setting Heater Overcurrent Detection

Operation Level

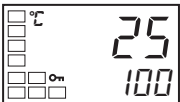

PV/SP

5. Press the Key for at least one second to move from the advanced function setting level to the initial setting level. Press the key again for at least one second to move to the operation level.

Adjustment Level

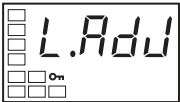

Adjustment Level Display

6. Press the Key for less than one second to move from the operation level to the adjustment level.

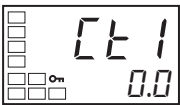

Heater Current 1 Value Monitor

7. Press the Key to select the Heater Current 1 Value Monitor parameter. Check the current value, and then set the Heater Overcurrent Detection parameter.



Heater Overcurrent Detection 1

8. Press the Key to select the Heater Overcurrent Detection 1 parameter. Refer to *Calculating Detection Current Values* on page 75 when setting the values.



9. For this example, set 20.0. To return to the operation level, press the Key for less than one second.

3-11 Setting the No. 3 Display

This section describes how to set the No. 3 Display (E5AN/EN). The Multi-SP, MV, or soak time remain can be displayed on the No. 3 display.

3-11-1 PV/SP Display Selection

The following table shows the set values and display contents for the PV/SP Display selection.

Set value	Display contents
0	Only PV/SP is displayed (with no No. 3 display.)
1	PV/SP/Multi-SP and PV/SP/MV are displayed in order. (See note.)
2	PV/SP/MV and PV/SP/Multi-SP are displayed in order. (See note.)
3	Only PV/SP/Multi-SP is displayed.
4	Only PV/SP/MV is displayed. (See note.)
5	PV/SP/Multi-SP and PV/SP/Soak time remain are displayed in order.
6	PV/SP/MV and PV/SP/Soak time remain are displayed in order. (See note.)
7	Only PV/SP/Soak time remain is displayed.

- A 2-level display is set when shipped from the factory. (set value: 0)
A 3-level display is activated if parameters are initialized. (set value: 4)

Note For details on setting the MV for heating and cooling control, refer to *MV Display for Heating and Cooling Control* below.

When 1, 2, 5, or 6 is selected, press the  Key to display the next value set for the PV/SP display (display 2).

Example: When the PV/SP Display Screen Parameter Is Set to 2

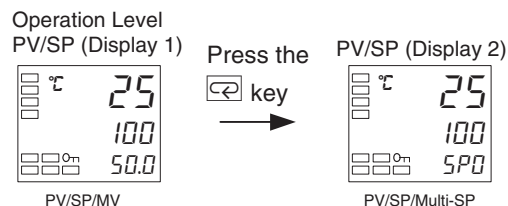

MV Display for Heating and Cooling Control

Select either the manipulated variable (heating) or manipulated variable (cooling) as the MV to be displayed for PV/SP/MV during heating and cooling control. The MV Display Selection parameter is displayed only when heating/cooling control is being performed and PV/SP/MV is selected in the PV/SP Display Screen parameter or a Monitor/Setting Item Display parameter.

Parameter name	Set value	Symbol	Display contents
MV Display Selection	0	\bar{a}	Manipulated variable (heating)
	C-O	$\bar{c} - \bar{a}$	Manipulated variable (cooling)

Operating Procedure

This procedure displays PV/SP/MV and PV/SP/Multi-SP on the Process Value/Set Point display. The PV/SP Display Screen Selection parameter is set to 2.

Operation Level

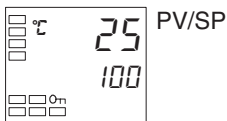

1. Press the Key for at least three seconds to move from the operation level to the initial setting level.

Initial Setting Level

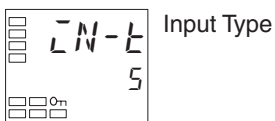

2. Press the Key to select the Move to Advanced Function Setting Level parameter.

Initial Setting Level

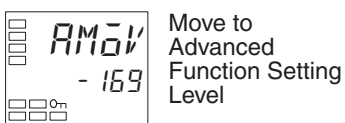

3. Use the Key to enter the password ("–169"). It is possible to move to the advanced function setting level by either pressing the Key or waiting two seconds without pressing any key.

Advanced Function Setting Level

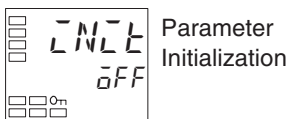

4. Press the Key to select the PV/SP Display Screen Selection parameter.

Advanced Function Setting Level

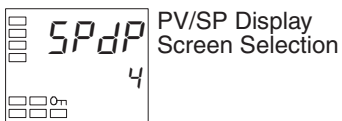

5. Use the and Keys to set 2.

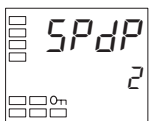

6. Press the Key for at least one second to move from the advanced function setting level to the initial setting level.

Initial Setting Level

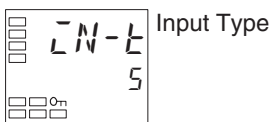

7. Press the Key for at least one second to move from the initial setting level to the operation level. The MV will be displayed on the No. 3 display.

Operation Level

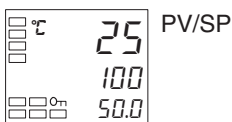

8. Press the Key to confirm that the Multi-SP is displayed on the No. 3 display.

Operation Level

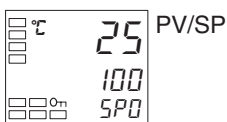

SECTION 4

Applications Operations

This section describes scaling, the SP ramp function, and other special functions that can be used to make the most of the functionality of the E5CN, E5AN, and E5EN Digital Temperature Controllers.

4-1	Shifting Input Values	89
4-1-1	Shifting Inputs	89
4-1-2	How to Calculate Input Shift Values for a 2-point Shift.	90
4-2	Alarm Hysteresis	93
4-2-1	Standby Sequence	93
4-2-2	Alarm Latch	94
4-3	Setting Scaling Upper and Lower Limits for Analog Inputs	94
4-3-1	Analog Input	94
4-4	Executing Heating/Cooling Control	95
4-4-1	Heating/Cooling Control	95
4-4-2	Settings	98
4-5	Using Event Inputs	99
4-5-1	Event Input Settings	99
4-5-2	How to Use the Multi-SP Function.	101
4-5-3	Settings	102
4-5-4	Operation Commands Other than Multi-SP	102
4-6	Setting the SP Upper and Lower Limit Values	104
4-6-1	Set Point Limiter.	104
4-6-2	Setting.	105
4-7	Using the SP Ramp Function to Limit the SP Change Rate	106
4-7-1	SP Ramp	106
4-8	Moving to the Advanced Function Setting Level	108
4-9	Using the Key Protect Level	110
4-9-1	Protection	110
4-9-2	Entering the Password to Move to the Protect Level	111
4-10	PV Change Color	113
4-10-1	PV Color Change Function.	113
4-10-2	Setting.	114
4-11	Alarm Delays	116
4-11-1	Alarm Delays	116
4-12	Loop Burnout Alarm.	118
4-12-1	Loop Burnout Alarm (LBA).	118
4-13	Performing Manual Control	122
4-13-1	Manual Operation	122
4-14	Using the Transfer Output.	126
4-14-1	Transfer Output Function	126

4-15	Using the Simple Program Function	129
4-15-1	Simple Program Function	129
4-15-2	Operation at the Program End.	132
4-15-3	Application Example Using a Simple Program	135
4-16	Output Adjustment Functions	136
4-16-1	Output Limits	136
4-16-2	MV at Stop	136
4-16-3	MV at PV Error.	137
4-17	Using the Extraction of Square Root Parameter	137
4-18	Setting the Width of MV Variation	139
4-19	Setting the PF Key.	141
4-19-1	PF Setting (Function Key).	141
4-20	Counting Control Output ON/OFF Operations	143
4-20-1	Control Output ON/OFF Count Function	143
4-21	Displaying PV/SV Status.	145
4-21-1	PV and SV Status Display Functions	145
4-22	Logic Operations	147
4-22-1	The Logic Operation Function (CX-Thermo).	147
4-22-2	Using Logic Operations	148

4-1 Shifting Input Values

4-1-1 Shifting Inputs

The input shift matched to the sensor currently selected in the Input Type parameter is displayed.

- A 2-point shift is applied for infrared temperature sensors. A 2-point shift can also be used if the Input Shift Type parameter (advanced function setting level) is set to INS2 for a thermocouple or platinum resistance thermometer.
- There is no shift for analog inputs. Use scaling for fine adjustments.

One-point shift



- With a 1-point shift, the value set for the Temperature Input Shift parameter (adjustment level) is applied to each point in the entire temperature input range. For example, if the input shift value is set to 1.2°C, the process value is treated as 201.2°C after the input shift is applied when the measured process value is 200°C.

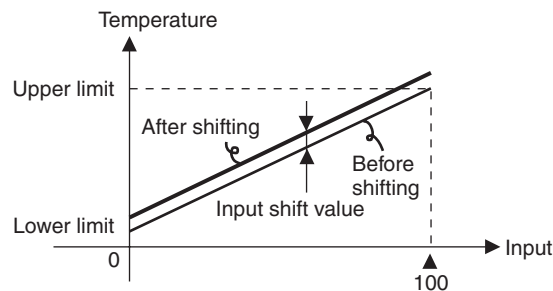

Operating Procedure

In this example, the input from a K sensor is shifted by 1°C using a 1-point input shift.

Operation Level

Operation Level

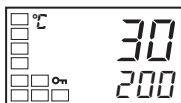

Adjustment Level

1. Press the Key to move from the operation level to the adjustment level.



2. Select the Temperature Input Shift parameter by pressing the Key.

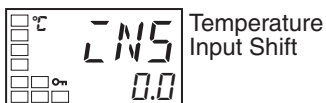

3. Press the or Key to set 1.0.

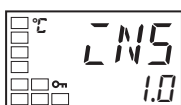

Operation Level

4. To return to the operation level, press the Key. The process value is 1°C larger than before the shift was applied.

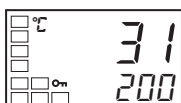

Two-point shift

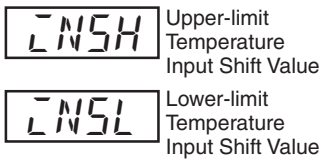

- Separate shift values can be set for the upper limit and lower limit of the sensor input range for an infrared sensor as well as for a thermocouple or platinum resistance thermometer with the Input Shift Type parameter set to INS2. If different shift values are set for the upper limit and lower limit, then the slope of the line will be different before and after applying the input shift. For example, if the upper-limit value is set to 2°C and the lower-limit value is set to 1°C, the input temperature will be shifted by 1.5°C for a 50% input, i.e., by the average of the upper-limit and lower-limit values.
- Set the upper-limit value in the Upper-limit Temperature Input Shift Value parameter and the lower-limit value in the Lower-limit Temperature Input Shift Value parameter.

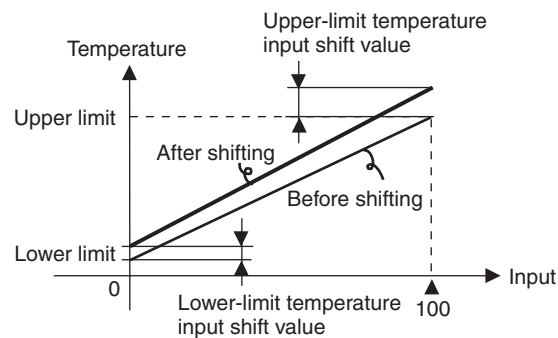

4-1-2 How to Calculate Input Shift Values for a 2-point Shift

When an ES1B Infrared Temperature Sensor is connected to the E5CN, an offset of several degrees to several tens of a degree can occur.

For this reason, offset the readout value using a 1-point or 2-point shift as described in this section. This offset occurs because a bias current for detecting a Controller sensor error flows to the output impedance of the infrared temperature sensor.

Preparations

- 1,2,3...**
1. Set a temperature range matching the input specifications of the infrared temperature sensor. (The ES1B can be used with the E5□N only for a thermocouple/resistance thermometer universal input.)
 2. Prepare a thermometer capable of measuring the temperature of the control target as shown in *Figure 1* so that a 1-point shift or 2-point shift can be carried out.
 3. The E53-CN□□P□N2 (for E5CN), E5AN-□□P□-N, or E5EN-□□P□-N has a built-in external power supply for ES1B Infrared Temperature Sensors. These E5CN models can be used as the power supply when using ES1B. When ES1B are used with other E5CN models, provide a separate power supply for the Infrared Temperature Sensors.

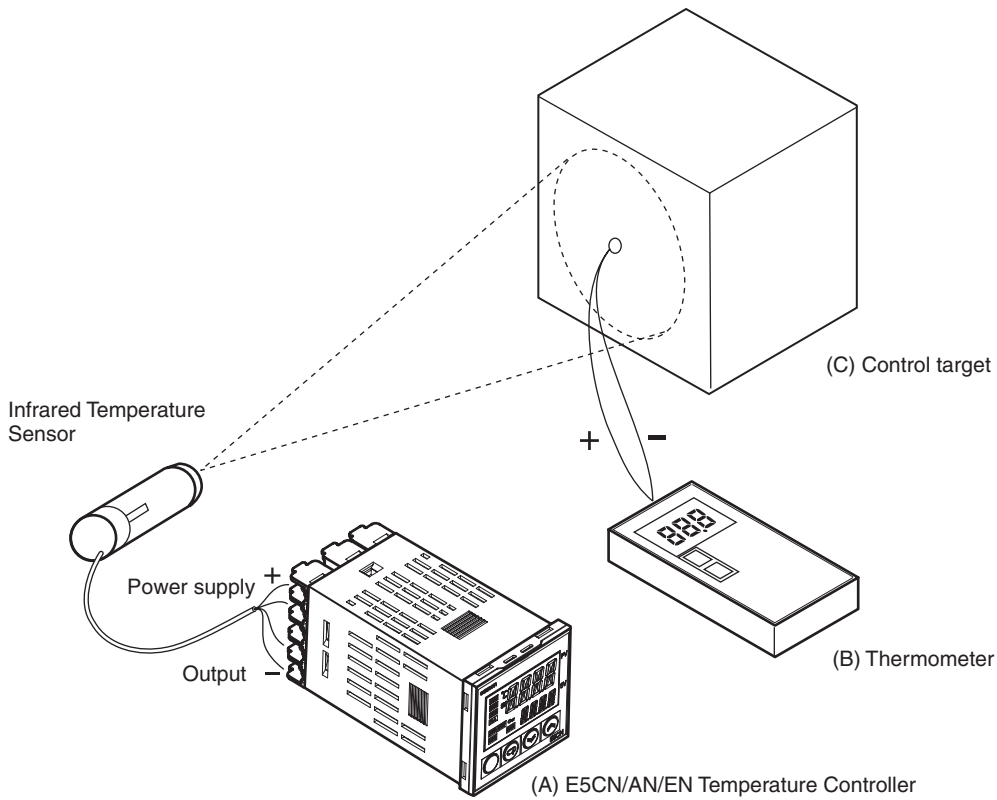

Figure 1 Offset Configuration for an Infrared Temperature Sensor

Method for a 1-point Shift

1,2,3...

1. In the configuration shown in *Figure 1*, bring the set point to near the value at which the temperature of the control target is to be controlled. Assume that the control target temperature (C) and the thermometer temperature (B) are the same.
2. Check the thermometer temperature (B) and the Controller readout (A). Subtract the Controller readout temperature (A) from the thermometer temperature (B), and set $\bar{L}NSL$ and $\bar{L}NSH$ to the result as the input shift value. The shift is illustrated in *Figure 2*.
3. After setting the input shift values, check the Controller readout (A) and the thermometer temperature (B). If they are almost the same, this completes shifting the temperature input.

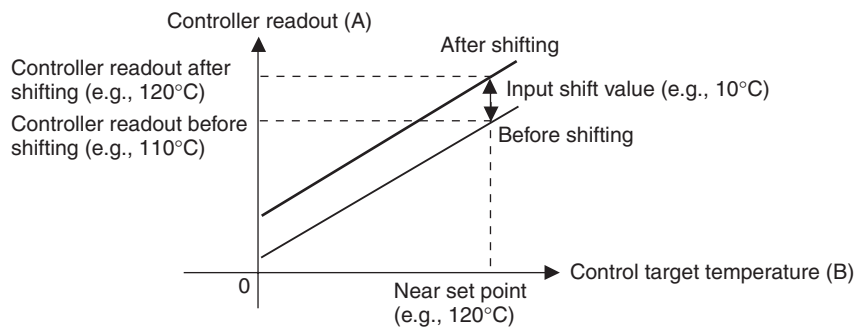
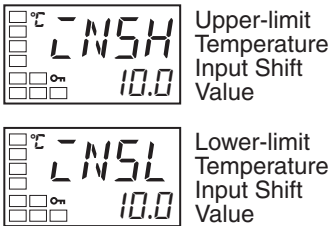

Figure 2 Illustration of 1-Point Shift

Method for a 2-point Shift

Use a 2-point input shift if you want to increase the accuracy of the readout values across the range of the Sensor.

1,2,3...

1. Shift the Controller readout at two points, near room temperature and near the value at which the temperature of the control target is to be controlled. For this reason, check the thermometer temperature (B) and Controller readout (A) with the thermometer temperature near room temperature and near the set point.
2.
 - Y1 is the Controller readout at room temperature before shifting and X1 is the Controller readout at room temperature after shifting.
 - Y2 is the Controller readout at the set temperature before shifting and X2 is the Controller readout at the set temperature after shifting.
 - Set the upper-limit temperature input shift and the lower-limit temperature input shift using the following formulas based on the temperatures before shifting (Y1 and Y2), the temperatures after shifting (X1 and X2), the set temperature upper limit (YH), and the set temperature lower limit (YL). The shift is illustrated in *Figure 3*.

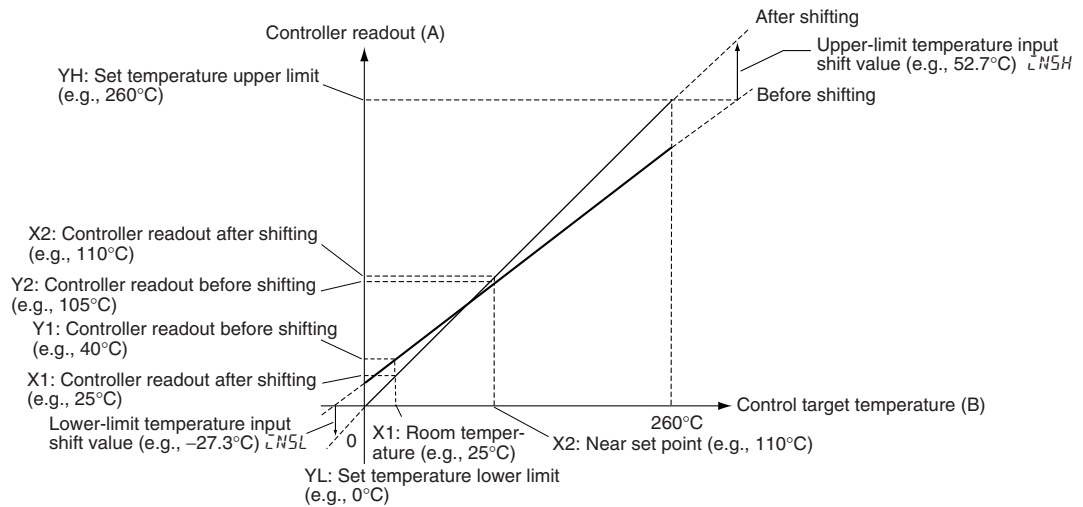

Figure 3 Illustration of 2-Point Shift

a. Lower-limit temperature input shift value

$$\bar{N}S_L = \frac{Y_L - Y_1}{Y_2 - Y_1} \times \{(X_2 - Y_2) - (X_1 - Y_1)\} + (X_1 - Y_1)$$

b. Upper-limit temperature input shift value

$$\bar{N}S_H = \frac{Y_H - Y_1}{Y_2 - Y_1} \times \{(X_2 - Y_2) - (X_1 - Y_1)\} + (X_1 - Y_1)$$

3. After setting the calculated values to $\bar{N}S_L$ and $\bar{N}S_H$, check the Controller readout (A) and thermometer temperature (B).
4. Here, offsets are set at two points, near room temperature and near the set point. To improve accuracy within the measurement temperature range, another point in the measurement temperature range other than the set point should be set instead of room temperature.

Example of a 2-point Temperature Input Shift

In this example, we use the ES1B K 0 to 260°C specification. In equations 1 and 2, the set temperature lower limit YL is 0°C and the set temperature upper limit YH is 260°C. Check the temperature of the control target.

The temperature input offset values can be calculated as shown below when the Controller readout Y1 is 40°C for a room temperature X1 of 25°C and when the Controller readout Y2 is 105°C for a set point temperature X2 of 110°C.

Lower-limit Temperature Input Shift Value

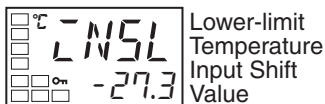

$$\bar{L}NSL = \frac{0 - 40}{105 - 40} \times \{(110 - 105) - (25 - 40)\} + (25 - 40) = -27.3 \text{ (}^\circ\text{C)}$$

Upper-limit Temperature Input Shift Value

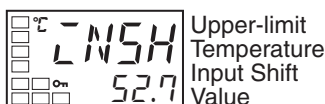

$$\bar{L}NSH = \frac{260 - 40}{105 - 40} \times \{(110 - 105) - (25 - 40)\} + (25 - 40) = 52.7 \text{ (}^\circ\text{C)}$$

4-2 Alarm Hysteresis

- The hysteresis of alarm outputs when alarms are switched ON/OFF can be set as follows:



- Alarm hysteresis is set independently for each alarm in the Alarm Hysteresis 1 to Alarm Hysteresis 3 parameters (initial setting level).
- The default is 0.2 (°C/°F) for Controllers with Thermocouple/Resistance Thermometer Universal Inputs and 0.02% FS for Controllers with Analog Inputs.

4-2-1 Standby Sequence

- The standby sequence can be used so that an alarm will not be output until the process value leaves the alarm range once and then enters it again.
- For example, with a lower limit alarm, the process value will normally be below the set point, i.e., within the alarm range, when the power supply is turned ON, causing an alarm to be output. If the lower limit alarm with a standby sequence is selected, an alarm will not be output until the process value increases above the alarm set value, i.e., until it leaves the alarm range, and then falls back below the alarm set value.

Restart

- The standby sequence is canceled when an alarm is output. It is, however, restarted later by the Standby Sequence Reset parameter (advanced function setting level). For details, refer to the Standby Sequence Reset parameter in SECTION 5 Parameters.

4-2-2 Alarm Latch

- The alarm latch can be used to keep the alarm output ON until the latch is canceled regardless of the temperature once the alarm output has turned ON.

Any of the following methods can be used to clear the alarm latch.

- Turn OFF the power supply. (The alarm latch is also cleared by switching to the initial setting level, communications setting level, advanced function setting level, or calibration level.)
- Use the PF Key.
- Use an event input.

For details on setting the PF Key, refer to 4-19 *Setting the PF Key*. For details on setting events, refer to 4-5 *Using Event Inputs*.

Summary of Alarm Operation

The following figure summarizes the operation of alarms when the Alarm Type parameter is set to “lower-limit alarm with standby sequence” and “close in alarm” is set.

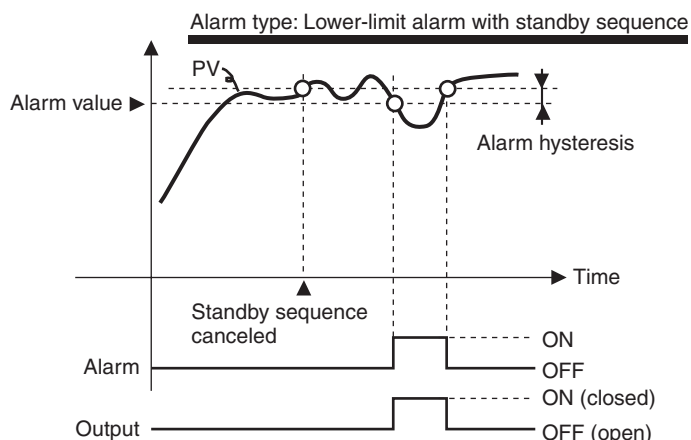

Parameters

Symbol	Parameter: level	Description
<i>ALH*</i>	Alarm 1 to 3 Hysteresis: Initial setting level	Alarm
<i>RESL</i>	Standby Sequence: Advanced function setting level	Alarm

Note * = 1 to 3

4-3 Setting Scaling Upper and Lower Limits for Analog Inputs

4-3-1 Analog Input

UN-H

Scaling Upper Limit

UN-L

Scaling Lower Limit

dP

Decimal Point

- When an analog input is selected, scaling can be performed as needed by the control application.
- Scaling is set in the Scaling Upper Limit, Scaling Lower Limit, and Decimal Point parameters (initial setting level). These parameters cannot be used when a temperature input is selected.
- The Scaling Upper Limit parameter sets the physical quantity to be expressed by the upper limit value of input, and the Scaling Lower Limit parameter sets the physical quantity to be expressed by the lower-limit value of input. The Decimal Point parameter specifies the number of digits below the decimal point.

- The following figure shows a scaling example for a 4 to 20 mV input. After scaling, the humidity can be directly read. Here, one place below the decimal point is set.

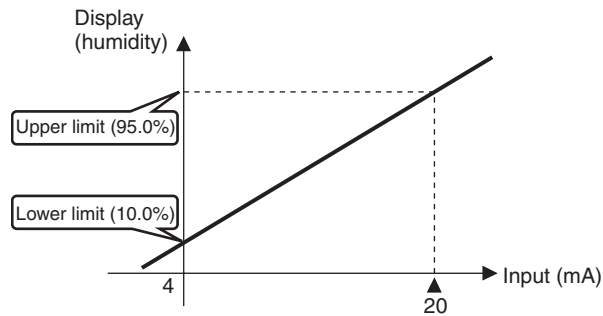

Operating Procedure

In this example scaling is set to display 4 to 20 mA as 10.0% to 95.0%.

Initial Setting Level

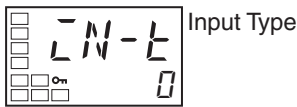

Input Type



Scaling Upper Limit

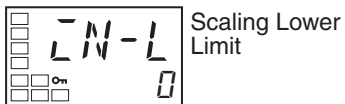
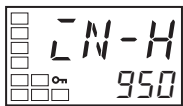

Scaling Lower Limit

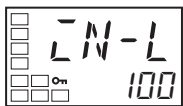

Decimal Point

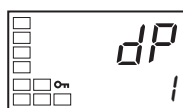

- Press the Key for three seconds to move from the operation level to the initial setting level.
- Select Scaling Upper Limit parameter by pressing the Key.
- Use the and Keys to set the parameter to 950.
- Select the Scaling Lower Limit parameter by pressing the Key.
- Press the and Keys to set 100.
- Select the Decimal Point parameter by pressing the Key.
- Press the and Keys to set 1.
- To return to the operation level, press the Key for one second.

4-4 Executing Heating/Cooling Control

4-4-1 Heating/Cooling Control

Heating/cooling control can be used on the E5CN-□M□-500 (with an E53-CNQ□□N2), E5CN-□2M□-500, E5AN-□3□M□-500-N or E5EN-□3□M□-500-N. Heating/cooling control operates when H-□ (heating/cooling) is selected for the Standard or Heating/Cooling parameter.

The following functions are assigned to outputs in the initial status.

Parameter name	Symbol	Initial status
Control Output 1 Assignment	$\bar{a}Ut1$	Control output for heating
Control Output 2 Assignment	$\bar{a}Ut2$	Not assigned.
Auxiliary Output 1 Assignment	$Sub1$	Alarm 1
Auxiliary Output 2 Assignment	$Sub2$	Alarm 2
Auxiliary Output 3 Assignment (E5AN/EN only)	$Sub3$	Alarm 3

Each output assignment is automatically initialized as shown below when the control mode is changed.

Example: E5CN

Parameter name	Symbol	Without control output 2		With control output 2	
		Standard	Heating/cooling	Standard	Heating/cooling
Control Output 1 Assignment	$\bar{a}Ut1$	Control output (heating)	Control output (heating)	Control output (heating)	Control output (heating)
Control Output 2 Assignment	$\bar{a}Ut2$	Not assigned. (See note 1.)	Not assigned. (See note 1.)	Not assigned.	Control output (cooling)
Auxiliary Output 1 Assignment	$Sub1$	Alarm 1 (See note 2.)	Alarm 1 (See note 2.)	Alarm 1 (See note 2.)	Alarm 1 (See note 2.)
Auxiliary Output 2 Assignment	$Sub2$	Alarm 2 (See note 3.)	Control output (cooling) (See note 3.)	Alarm 2	Alarm 2

Example: E5GN

Parameter name	Symbol	Standard	Heating/cooling
Control Output 1 Assignment	$\bar{a}Ut1$	Control output (heating)	Control output (heating)
Auxiliary Output 1 Assignment	$Sub1$	Alarm 1 (See note 2.)	Control output (cooling)
Auxiliary Output 2 Assignment	$Sub2$	Alarm 2	Alarm 2

- Note**
- (1) No parameter assignment is displayed because there is no control output 2.
 - (2) The output set for the Auxiliary Output 1 Assignment parameter becomes the program END output unless the program pattern is OFF.
 - (3) For the E5AN/EN, the Auxiliary Output 3 Assignment parameter is set for control output (cooling) (the Auxiliary Output 2 Assignment parameter is set for alarm 2).
 - The heating/cooling operation of the control outputs will switch when the Direct/Reverse Operation parameter is set to “direct.”
 - When DRS (Invert Direct/Reverse Operation) is assigned for an Event Input Assignment (1 or 2), control will start with the contents set for the Direct/Reverse Operation parameter inverted when the event input turns ON, and with the contents left according to the setting when the event input turns OFF. For details on event inputs and control combined with the Direct/Reverse Operation parameter, refer to *Control by Inverting Direct/Reverse Operation* on page 103.
 - When heating/cooling control is selected, the Dead Band and Cooling Coefficient parameters can be used.

Dead Band

- For heating/cooling control, the dead band is set with the set point as its center. The dead band width is the set value of the Dead Band parameter (adjustment level). Setting a negative value produces an overlapping band.
- If an overlapping band is set, the bumpless function may not operate when switching between manual operation and automatic operation.
- The default is 0.0 EU for Controllers with Thermocouple/Resistance Thermometer Universal Inputs and 0.00% FS for Controllers with Analog Inputs.

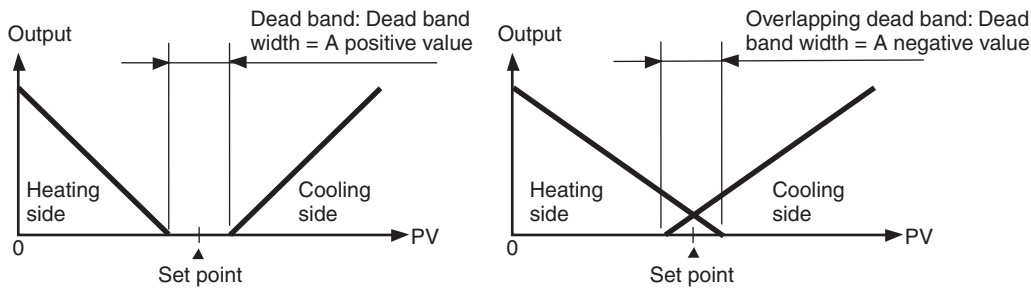

Cooling Coefficient

If the heating characteristics and cooling characteristics of the control object are very different and good control characteristics cannot be achieved with the same PID constants, the cooling coefficient can be used to adjust the proportional band (P) for the control output assigned to the cooling side. Use this to achieve balanced control between the heating side and cooling side. The proportional bands (P) for the control outputs assigned to the heating/cooling sides can be calculated using the following equations.

P for control output assigned to heating side = P

P for control output assigned to cooling side = P for control output assigned to heating side \times cooling coefficient

The cooling coefficient is multiplied by the P for the control output assigned to the heating side to obtain control with characteristics that differ from those of the control output assigned to the heating side.

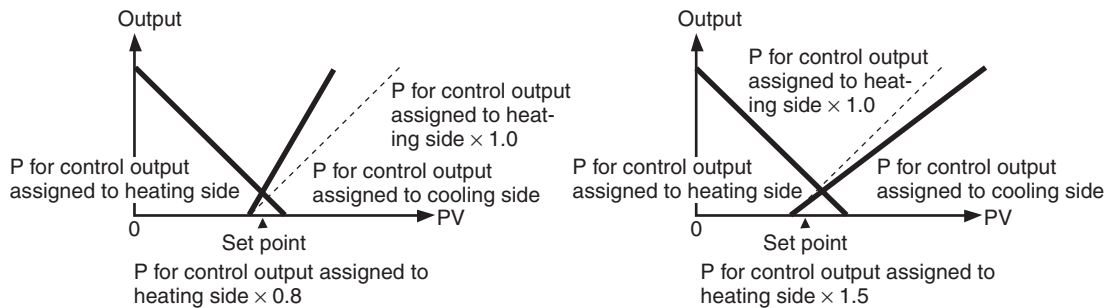

Automatic Cooling Coefficient Adjustment

By executing AT during heating/cooling control, the cooling coefficient can be automatically calculated along with the PID parameters.

Parameter name	Setting range	Default
Automatic Cooling Coefficient Adjustment	OFF: Disabled, ON: Enabled	OFF

Note If there is strong non-linear gain for the cooling characteristics, such as when cooling water boils for cooling control, it may not be possible to obtain the optimum cooling coefficient at the Controller, and control may take the form of

oscillating waves. If that occurs, increase the proportional band or the cooling coefficient to improve control.

4-4-2 Settings

To set heating/cooling control, set the Standard or Heating/Cooling, Dead Band, and Cooling Coefficient parameters.

Setting Heating/Cooling Control

Operating Procedure

Standard or heating/cooling = Heating/cooling

Initial Setting Level



1. Press the Key for at least three seconds to move from the operation level to the initial setting level.

2. Select "heating/cooling control" in the initial setting level.
STND: Standard control
H-C: Heating/cooling control

Setting the Cooling Coefficient

Operating Procedure

Cooling Coefficient = 10

Adjustment Level

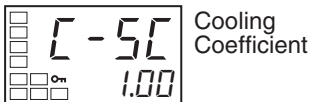

1. Select the Cooling Coefficient parameter in the adjustment level.



2. Use the Key to set the parameter to 10.00.

Setting the Dead Band

Operating Procedure

Dead Band = 5

Adjustment Level

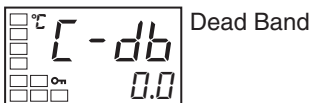

1. Select the Dead Band parameter in the adjustment level.

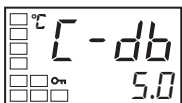

2. Use the Key to set the parameter to 5.0.

4-5 Using Event Inputs

4-5-1 Event Input Settings

- Event inputs can be used for Multi-SP, RUN/STOP, Auto/Manual Switch, Program Start, Invert Direct/Reverse Operation, 100% AT Execute/Cancel, 40% AT Execute/Cancel, Setting Change Enable/Disable, and Alarm Latch Cancel.
- Of these, only the number of event inputs (0 to 2) set in the Number of Multi-SP Uses parameter (initial setting level) are used for the multi-SP function.
- Of these, only the number of event inputs (0 to 2) set in the Number of Multi-SP Uses parameter (initial setting level) are automatically assigned by the multi-SP function. Displays for event input assignments will not be displayed for inputs that are automatically assigned by the multi-SP function. Event inputs 1 and 2 are used for the multi-SP function by models with four event inputs.
- Event inputs can be used on the following models:
E5CN-□M□-500 with the E53-CN□B□N2 for the E5CN
E5AN/EN-□M□-500-N with the E53-AKB for the E5AN/EN
- When using event inputs to switch the multi-SP, the event input assignment display will not appear. Whether the set value and event input assignments 1 and 2 will be displayed or hidden is shown in the tables below.
- Do not connect the contacts from the same switch to more than one E5□N Controllers.

Models with Two Event Inputs, 1 and 2

		Event input assignment 1	Event input assignment 2	Description of EV1 and EV2 operation
Number of Multi-SP Uses	0	Displayed (Multi-SP not used).		EV1 and EV2 will perform the operation command assigned using the Event Input Assignment 1 and 2 parameters.
	1	Not displayed (Operation performed with two Multi-SP points.)	Displayed (Event input 2 not used as multi-SP switch).	EV1 will be used for the Multi-SP function to switch between set points 0 and 1. EV2 will perform the operation command assigned using the Event Input Assignment 2 parameter.
	2	Not displayed (Operation performed with four Multi-SP points.)		EV1 and EV2 will be used for the Multi-SP function to switch between set points 0, 1, 2, and 3.

Models with Two Event Inputs, 3 and 4

		Event input assignment 3	Event input assignment 4	Description of EV3 and EV4 operation
Number of Multi-SP Uses	0	Displayed (Multi-SP not used).		EV3 and EV4 will perform the operation command assigned using the Event Input Assignment 3 and 4 parameters.
	1	Not displayed (Operation performed with two Multi-SP points.)	Displayed (Event input 4 not used as multi-SP switch).	EV3 will be used for the Multi-SP function to switch between set points 0 and 1. EV4 will perform the operation command assigned using the Event Input Assignment 2 parameter.
	2	Not displayed (Operation performed with four Multi-SP points.)		EV3 and EV4 will be used for the Multi-SP function to switch between set points 0, 1, 2, and 3.

Models with Four Event Inputs, 1 to 4

		Event input assignment 1	Event input assignment 2	Event input assignment 3	Event input assignment 4	Description of EV1, EV2, EV3, and EV4 operation
Number of Multi-SP Uses	0	Displayed (Multi-SP not used).				EV1, EV2, EV3, and EV4 will perform the operation command assigned using the Event Input Assignment 1, 2, 3, and 4 parameters.
	1	Not displayed (Operation performed with two Multi-SP points.)	Displayed (Event inputs 2, 3, and 4 cannot be used for multi-SP switching.)			EV1 will be used for the Multi-SP function to switch between set points 0 and 1. EV2, EV3, and EV4 will perform the operation command assigned using the Event Input Assignment 2, 3, and parameters.
	2	Not displayed (Operation performed with four Multi-SP points.)		Displayed (Event inputs 3 and 4 cannot be used for multi-SP switching.)		EV1 and EV2 will be used for the Multi-SP function to switch between set points 0, 1, 2, and 3. EV3 and EV4 will perform the operation command assigned using the Event Input Assignment 3 and 4 parameters.

Two set points are set externally by using the Number of Multi-SP Uses parameter.

- Switching is possible between two set points (0 and 1) by setting the Number of Multi-SP Uses parameter to 1. The default setting is 1 and does not need to be changed to switch between two set points. Set points 0 and 1 are specified by the status of event input 1.

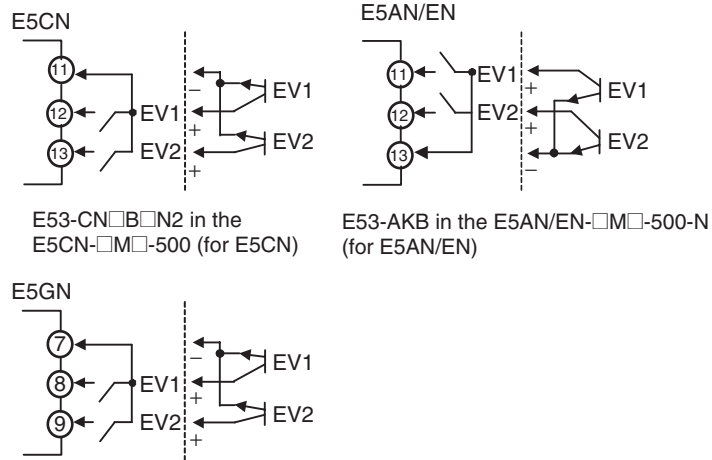

4-5-2 How to Use the Multi-SP Function

The multi-SP function allows you to set up to four set points (SP 0 to 3) in the adjustment level. The set point can be switched by operating the keys on the front panel or by using external input signals (event inputs).

Using Event Inputs

■ Two Event Inputs: Event Inputs 1 and 2

The following tables show the relationship between the ON/OFF combinations of event inputs 1 and 2 and the selected set points.

Number of Multi-SP Uses = 1

Event input 1	Selected set point
OFF	Set point 0
ON	Set point 1

Number of Multi-SP Uses = 2

Event input 1	Event input 2	Selected set point
OFF	OFF	Set point 0
ON	OFF	Set point 1
OFF	ON	Set point 2
ON	ON	Set point 3

Using Key Operations

You can select any of the set points 0 to 3 by changing the set value of the Multi-SP Uses parameter. The Multi-SP Uses parameter display conditions are as follows:

- If the Controller does not support event inputs, the Multi-SP Uses parameter must be set to ON.
- If the Controller supports event inputs, the Number of Multi-SP Uses parameter must be set to 0 and the Multi-SP Uses parameter must be set to ON.

The following table shows the relationship between the Multi-SP Uses parameter set value and the selected set point.

Multi-SP	Selected set point
0	Set point 0
1	Set point 1
2	Set point 2
3	Set point 3

Note The set point can also be switched using communications.

4-5-3 Settings

Switching between Set Points 0, 1, 2, and 3

Operating Procedure

The following example sets the Number of Multi-SP Uses parameter to 2.

Operation Level



1. Press the Key for at least three seconds to move from the operation level to the initial setting level.

Number of Multi-SP Uses Setting

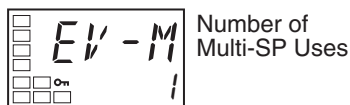

2. Select the Number of Multi-SP Uses parameter by pressing the Key.

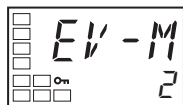

3. Use the Key to set the parameter to 2.

Set points 0, 1, 2 and 3 will be set according to the ON/OFF states of event inputs 1 and 2.

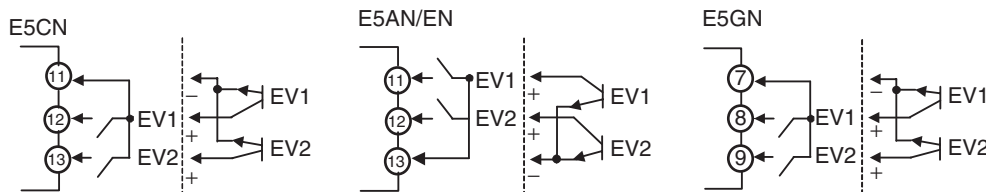

4-5-4 Operation Commands Other than Multi-SP

The following table shows the functions assigned when an Event Input Assignment (1 or 2) is displayed.

Setting	Function
<i>NONE</i>	None
<i>STOP</i>	RUN/STOP
<i>MANU</i>	Auto/Manual
<i>PRSt</i>	Program Start (See note 1.)
<i>dRS</i>	Invert Direct/Reverse Operation
<i>RE-2</i>	100% AT Execute/Cancel
<i>RE-1</i>	40% AT Execute/Cancel (See note 2.)
<i>WLPt</i>	Setting Change Enable/Disable
<i>LRE</i>	Alarm Latch Cancel

- Note**
- (1) PRST (Program Start) can be set even when the Program Pattern parameter is set to OFF, but the function will be disabled.
 - (2) This function can be set for heating/cooling control, but the function will be disabled.

When any of the following functions is set for an Event Input Assignment parameter, the same function cannot be set for another Event Input Assignment parameter: STOP (RUN/STOP), MANU (Auto/Manual Switch), PRST (Program Start), DRS (Invert Direct/Reverse Operation), AT-2 (100% AT Execute/Cancel), AT-1 (40% AT Execute/Cancel), WTPT (Setting Change Enable/Disable), or LAT (Alarm Latch Cancel). Turn event inputs ON and OFF while the power is being supplied. Event input ON/OFF changes are detected for inputs of 50 ms or longer. (However, inputs of 250 ms or longer is determined using logic operations.)

The functions are described in detail below. Event inputs 1 and 2 are taken as examples.

Executing Run/Stop Control

When the Event Input Assignment 1 or Event Input Assignment 2 parameter is set to STOP (RUN/STOP), control is started when event input 1 or 2 turns OFF. Control is stopped when the input turns ON. Alarm outputs, however, will be according to the process value.

The STOP indicator will light while control is stopped.

Setting	Input contact	Status
Event input 1 or 2	ON	STOP
Event input 1 or 2	OFF	RUN

Switching between Auto and Manual Control

When the Event Input Assignment 1 or Event Input Assignment 2 parameter is set to MANU (auto/manual), manual control will start when event input 1 or 2 turns ON. Auto control will start when the input turns OFF.

The MANU indicator will light during manual control.

Setting	Input contact	Status
Event input 1 or 2	OFF	Automatic
Event input 1 or 2	ON	Manual

Controlling the Start of the Simple Program Function

When the Event Input Assignment 1 or Event Input Assignment 2 parameter is set to PRST (program start), the program will start when event input 1 or 2 turns ON. The program will be reset when the input turns OFF and the RUN/STOP status will automatically switch to STOP mode. If the program END output is ON, the program END output will turn OFF.

Setting	Input contact	Status
Event input 1 or 2	OFF	Reset
Event input 1 or 2	ON	Start

Control by Inverting Direct/Reverse Operation

When DRS (Invert Direct/Reverse Operation) is set for the Event Input Assignment 1 or Event Input Assignment 2 parameter and the Direct/Reverse Operation parameter is set for reverse operation, control starts with direct operation (cooling control) when event input 1 or 2 turns ON and control starts with reverse operation (heating control) when the event input turns OFF.

Setting	Input contact	Direct/Reverse Operation parameter	Status
Event input 1 or 2	OFF	Direct operation (cooling)	Direct operation (cooling)
		Reverse operation (heating)	Reverse operation (heating)

Setting	Input contact	Direct/Reverse Operation parameter	Status
Event input 1 or 2	ON	Direct operation (cooling)	Reverse operation (heating)
		Reverse operation (heating)	Direct operation (cooling)

Switching 100% AT Execute/Cancel

When AT-2 (100% AT Execute/Cancel) is set for either the Event Input Assignment 1 or Event Input Assignment 2 parameter, 100% AT will be executed when event input 1 or 2 turns ON and will be cancelled when the input turns OFF.

Setting	Input contact	Status
Event input 1 or 2	OFF	100% AT cancelled
Event input 1 or 2	ON	100% AT executed

Switching 40% AT Execute/Cancel

When AT-1 (40% AT Execute/Cancel) is set for either the Event Input Assignment 1 or Event Input Assignment 2 parameter, 40% AT will be executed when event input 1 or 2 turns ON and will be cancelled when the input turns OFF.

Setting	Input contact	Status
Event input 1 or 2	OFF	40% AT cancelled
Event input 1 or 2	ON	40% AT executed

Switching Setting Change Enable/Disable

When WTPT (Setting Change Enable/Disable) is set for either the Event Input Assignment 1 or Event Input Assignment 2 parameter, the setting change will be disabled when event input 1 or 2 turns ON and will be enabled when the input turns OFF.

Setting	Input contact	Status
Event input 1 or 2	OFF	Enabled
Event input 1 or 2	ON	Disabled

Switching Alarm Latch Cancel

When LAT (Alarm Latch Cancel) is set for either the Event Input Assignment 1 or Event Input Assignment 2 parameter, all alarm latches (alarms 1 to 3, heater burnout, HS alarm, and heater overcurrent latch) will be cancelled when event input 1 or 2 turns ON.

Setting	Input contact	Status
Event input 1 or 2	OFF	---
Event input 1 or 2	ON	Cancelled

Parameters

Symbol	Parameter: level	Description
<i>EV-1</i>	Event Input Assignment 1: Initial setting level	Function of event input function
<i>EV-2</i>	Event Input Assignment 2: Initial setting level	
<i>EV-M</i>	Number of Multi-SP Uses: Initial setting level	

4-6 Setting the SP Upper and Lower Limit Values

4-6-1 Set Point Limiter

The setting range of the set point is limited by the set point limiter. This function can be used to prevent setting incorrect process values. The set point limiter is used to prevent the control target from reaching abnormal temperatures. If the set point is not within the range set for the set point limiter as the result of changes to the Set Point Upper Limit or Set Point Lower Limit parameter, the set point will automatically be change to a value within the set

range. The upper- and lower-limit values of the set point limiter are set using the Set Point Upper Limit and Set Point Lower Limit parameters in the initial setting level. When the set point limiter is reset, the set point is forcibly changed to the upper- or lower-limit value of the set point limiter if the set point is out of the limiter range. Also, when the input type and the temperature unit, scaling upper-limit value, or lower-limit value are changed, the set point limiter is forcibly reset to the input setting range or the scaling upper- or lower-limit value.

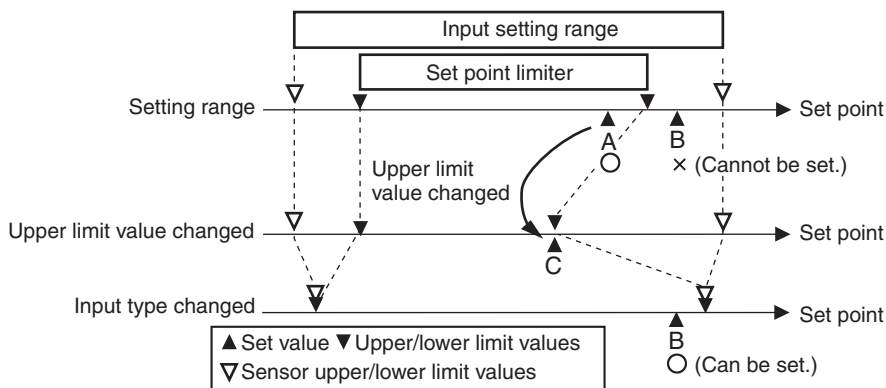

Parameters

Symbol	Parameter: level	Description
SL-H	Set Point Upper Limit: Initial setting level	To limit the SP setting
SL-L	Set Point Lower Limit: Initial setting level	To limit the SP setting

4-6-2 Setting

Set the set point upper and lower limits in the Set Point Upper Limit and Set Point Lower Limit parameters in the initial setting level. In this example, it is assumed that the input type is set to a K thermocouple with a temperature range of -200 to 1300°C.

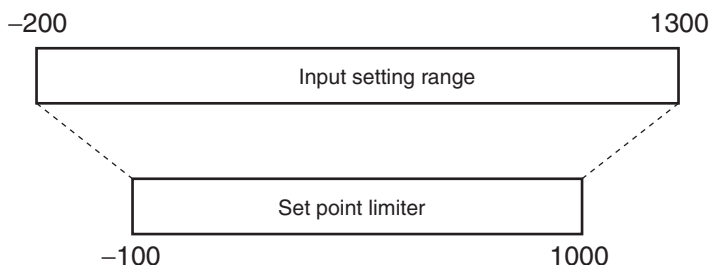

Setting the Set Point Upper-limit Value

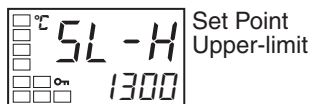
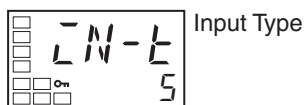

Operating Procedure

Set Point Upper Limit = 1000

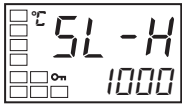

1. Press the Key for at least three seconds to move from the operation level to the initial setting level.
2. Select the Set Point Upper Limit parameter.



- Use the  and  Keys to set the parameter to 1000.

Setting the Set Point Lower-limit Value

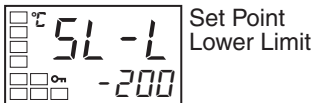

Operating Procedure

Set Point Lower Limit = -100

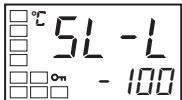

- Select the Set Point Lower Limit parameter in the initial setting level.



- Use the  and  Keys to set the parameter to -100.

4-7 Using the SP Ramp Function to Limit the SP Change Rate

4-7-1 SP Ramp

The SP ramp function is used to restrict the width of changes in the set point as a rate of change. When the SP ramp function is enabled and the change width exceeds the specified rate of change, an area where the set point is restricted will be created, as shown in the following diagram.

During the SP ramp, control will be performed not for the specified set point but rather for the set point restricted by the rate of change set for the SP ramp function.

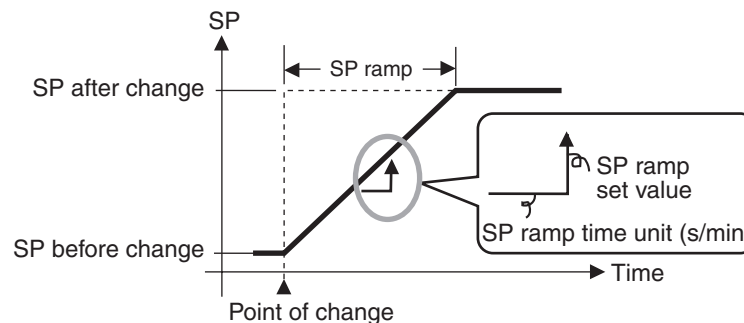

The rate of change during SP ramp is specified using the SP Ramp Set Value and SP Ramp Time Unit parameters. The SP Ramp Set Value parameter is set to OFF by default, i.e., the SP ramp function is disabled.

Changes in the ramp set point can be monitored in the Set Point During SP Ramp parameter (operation level). Use this parameter when monitoring SP ramp operation.

The SP ramp function operates in the same way when switching the set point using the multi-SP function.

Parameters

Symbol	Parameter: level	Description
$\bar{a}L-H$	MV Upper Limit: Adjustment level	To limit the manipulated variable
$\bar{a}L-L$	MV Lower Limit: Adjustment level	To limit the manipulated variable
$SL-H$	Set Point Upper Limit: Initial setting level	To limit the SP setting
$SL-L$	Set Point Lower Limit: Initial setting level	To limit the SP setting
$SPRE$	SP Ramp Set Value: Adjustment level	To limit the SP rate of change
$SPRU$	SP Ramp Time Unit: Advanced function setting level	Unit for setting the SP
$RLSP$	Alarm SP Selection: Advanced function setting level	Alarm SP selection

Operation at Startup

If the SP ramp function is enabled when the Controller is turned ON or when switching from STOP to RUN mode, the process value reaches the set point using the SP ramp function in the same way as when the set point is changed. In this case, operation is carried out with the process value treated as the set point before the change was made. The direction of the SP ramp changes according to the relationship between the process value and the set point.

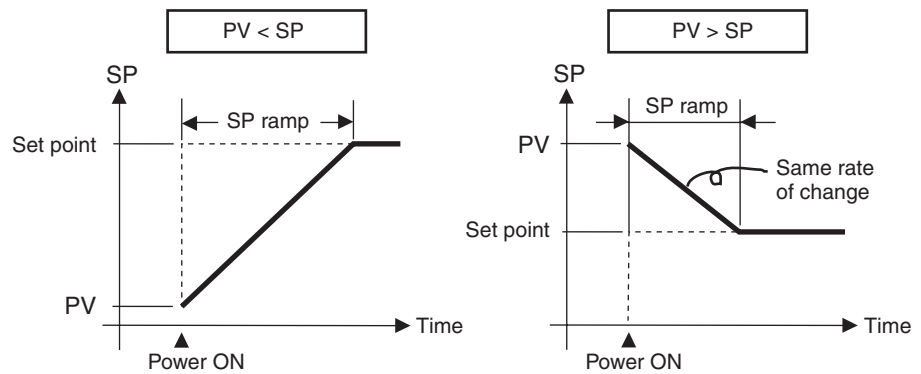

Restrictions during SP Ramp Operation

- Execution of auto-tuning starts after the end of the SP ramp.
- When control is stopped or an error occurs, the SP ramp function is disabled.

Alarms during SP Ramp Operation

The operation of alarms during SP ramp operation depends on whether alarms are set to be based on the ramp set point or the target set point (refer to the following diagrams). The set point to be used is set in the Alarm SP Selection parameter. (Refer to page 244.)

Alarm SP Selection = Ramp SP (Alarm Type: 1 (Upper/Lower Limits))

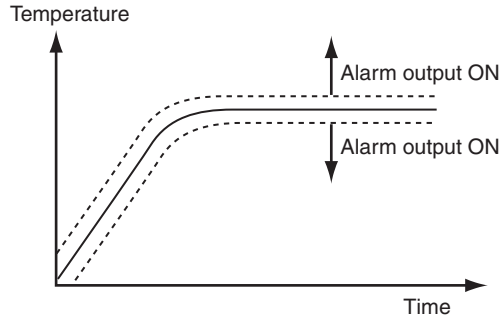

Alarm SP Selection = Target SP (Alarm Type: 1 (Upper/Lower Limits))

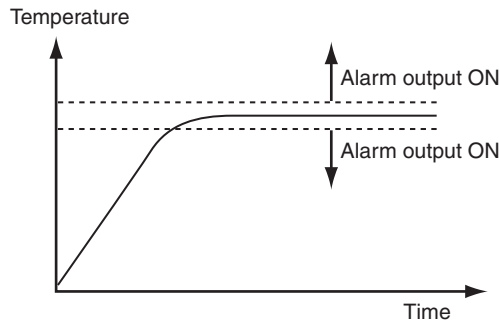

4-8 Moving to the Advanced Function Setting Level

To move to the advanced function setting level, you must first cancel the protection applied by the Initial Setting/Communications Protect parameter.

In the default setting, the advanced function setting level is protected and you cannot move to this setting level.

1,2,3...

1. Press the and Keys simultaneously for at least three seconds in operation level.

Note The key pressing time can be changed in the Move to Protect Level Time parameter (advanced function setting level).

2. The Controller moves to the protect level, and the Operation/Adjustment Protect parameter is displayed.

Protect Level



Operation/Adjustment Protect



Initial Setting/Communications Protect



3. Press the Key once to move to the Initial Setting/Communications Protect parameter.

4. Set the set value to 0.

Operation Level



5. Press the and Keys simultaneously for at least one second to return to the operation level.

Initial Setting Level

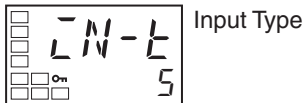

6. Move to the advanced function setting level. Press the Key for at least three seconds to move from the operation level to the initial setting level.

Initial Setting Level



7. Select the Move to Advanced Function Setting Level parameter by pressing the Key.

Advanced function setting level

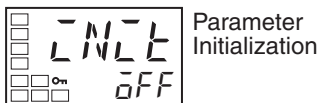

8. Press the Key, enter the password (-169), and then either press the Key or leave the setting for at least two seconds to move to the advanced function setting level from the initial setting level.

Initial Setting Level

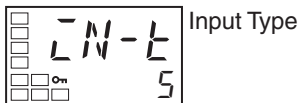

9. To return to the initial setting level, press the Key for at least one second.



Operation Level



10. To return to the operation level, press the Key for at least one second.

4-9 Using the Key Protect Level

4-9-1 Protection

- To move to the protect level, press the  and  Keys simultaneously for at least three seconds in operation level or adjustment level. (See note.)

Note The key pressing time can be changed in the Move to Protect Level Time parameter (advanced function setting level).

- The protect level protects parameters that are not changed during Controller operation until operation is started to prevent them from being modified unintentionally.

There are four types of protection: operation/adjustment protect, initial setting/communications protect, setting change protect, and PF Key protect.

- The protect level settings restrict the range of parameters that can be used.

Operation/Adjustment Protect



The following table shows the relationship between set values and the range of protection.

Level		Set value			
		0	1	2	3
Operation level	PV	Can be displayed	Can be displayed	Can be displayed	Can be displayed
	PV/SP	Can be displayed and changed	Can be displayed and changed	Can be displayed and changed	Can be displayed
	Others	Can be displayed and changed	Can be displayed and changed	Cannot be displayed and moving to other levels is not possible	Cannot be displayed and moving to other levels is not possible
Adjustment level		Can be displayed and changed	Cannot be displayed and moving to other levels is not possible	Cannot be displayed and moving to other levels is not possible	Cannot be displayed and moving to other levels is not possible

- Parameters are not protected when the set value is set to 0.
- The default is 0.

Initial Setting/Communications Protect



This protect level restricts movement to the initial setting level, communications setting level, and advanced function setting level.

Set value	Initial setting level	Communications setting level	Advanced function setting level
0	Possible to reach	Possible to reach	Possible to reach
1	Possible to reach	Possible to reach	Not possible to reach
2	Not possible to reach	Not possible to reach	Not possible to reach

- The default is 1.

Setting Change Protect

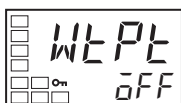

This protect level restricts key operations.

Set value	Description
OFF	Settings can be changed using key operations.
ON	Settings cannot be changed using key operations. (The protect level settings, however, can be changed.)

- The default is OFF.
- The all protect indication (On) will light when setting change protect is set.

PF Key Protect



This protect level enables or disables PF Key operations.

Set value	Description
OFF	PF Key enabled.
ON	PF Key disabled (Operation as function key prohibited).

- The default is OFF.

4-9-2 Entering the Password to Move to the Protect Level

- Protect level can be moved to only by display the password display and entering the correct password. (The user can set any password in the Protect Level Password parameter. If no password is set (i.e., if the password is set to 0 in the Protect Level Password parameter), the password input display to move to protect level will not be displayed and the protect level can be moved to directly.

Operating Procedure

Use the following procedure to move to protect level.

■ **Example with a Password of 1234**

Operation Level



Protect Level



1. Press the [] and [] Keys simultaneously for at least the time set in the Move to Protect Level Time parameter to move from the operation level to the protect level.



2. Press the [] Key to set the parameter to 1234 (password input).

Protect Level

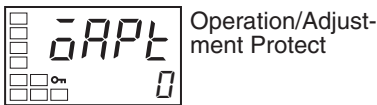

3. Move to the Operation/Adjustment Protect parameter by pressing the [] or [] Key or leaving the setting for at least two seconds.

■ **Example with No Password Set**

Operation Level



Protect Level



Press the [] and [] Keys simultaneously for at least the time set in the Operation/Adjustment Protect parameter to move from the operation level to the protect level.

When a password is not set, the Operation/Adjustment Protect parameter will be displayed.

Setting the Password

Operating Procedure

Use the following procedure to set the password to move to the protect level.

■ Example To set the Password to 1234

Operation Level



Protect Level



1. Press the and Keys simultaneously for at least the time set in the Move to Protect Level Time parameter to move from the operation level to the protect level.

Protect Level



2. Select the Password to Move to Protect Level parameter by pressing the Key.



3. Press the and Keys to set the parameter to 1234. (To prevent setting the password incorrectly, the and Keys or and Keys must be pressed simultaneously to set the password.)

Note Protection cannot be cleared or changed without the password. Be careful not to forget it. If you forget the password, contact your OMRON sales representative.

Communications Operation Command to Move to the Protect Level

- The Write Variable operation command can be used via communications to write the password to the Move to Protect Level parameter. When the correct password is written, the display will change to the Operation/Adjustment Protect parameter and writing the parameters in the protect level will be enabled.

Note

- (1) If the Write Variable operation command is used to write the wrong password to the Move to Protect Level parameter after the correct parameter has been written, the Move to Protect Level parameter will be displayed and any Write Variable operation commands to write parameters in the protect level will result in operation errors.
- (2) If a password is not set or if it is set to 0, the display will change to the Operation/Adjustment Protect parameter and writing the parameters in the protect level will be enabled immediately.

4-10 PV Change Color

4-10-1 PV Color Change Function

Use the PV color change function to change the color of the PV display (No. 1 display).

There are three display colors, orange, red, and green, and you can select from the following three modes and eight functions.



- Constant: This mode displays orange, red, or green all the time.
- Linked to Alarm 1: This mode switches the PV display color from red to green when alarm 1 turns ON or from green to red when alarm 1 turns ON.
- Linked to PV stable band: This mode switches the PV display color between red outside the PV stable band and green within PV stable band, or between green outside the PV stable band and red within PV stable band.
Set the PV stable band in the PV Stable Band parameter (advanced function setting level).
- The default is *REd* (red).

The following tables shows the display functions that can be set using the PV color change function.

Mode	Setting	Function	PV change color			Application example	
Constant	<i>āRĒ</i>	Orange	Constant: Orange			To match the display color with other Controller models	
	<i>REd</i>	Red	Constant: Red			To match the display color with other Controller models	
	<i>ĒRN</i>	Green	Constant: Green			To match the display color with other Controller models	
Linked to alarm 1							
			ALM1 not lit	ALM1 lit	Application example		
	<i>R-Ē</i>	Red to Green	Red	Green	To display the PV reached signal		
	<i>Ē-R</i>	Green to Red	Green	Red	To display error signals		
Linked to PV stable band							
			Low	Within PV stable band	High	Application example	
	<i>R-Ē,R</i>	Red to Green to Red	Red	Green	Red	To display stable status	
	<i>Ē-ā,R</i>	Green to Orange to Red	Green	Orange	Red	To display stable status	
	<i>ā-Ē,R</i>	Orange to Green to Red	Orange	Green	Red	To display stable status	

PV Stable Band



When the mode to link to the PV stable band is selected, the PV display color will change according to whether the present value (PV) is lower than, within, or higher than the PV stable band shown in the following figure. The PV stable band is set with the SP as the center, as shown below.

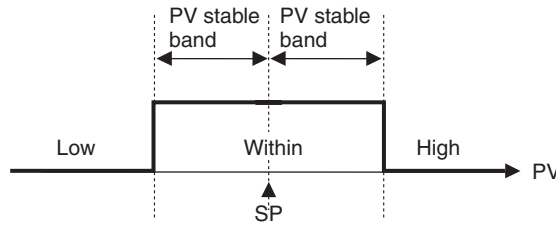

The default is 5.0 (°C/°F) for Controllers with Thermocouple/Resistance Thermometer Universal Inputs and 5.00% FS for Controllers with Analog Inputs.

4-10-2 Setting

Setting the PV Change Color to Indicate Stable Status

To display the PV in a stable green display when the PV is within ±15.0°C of the set point to enable checking the control process at a glance, set the PV Change Color and PV Stable Band parameters.

PV change color = R - GR (Red to Green to Red)

PV stable band = 15.0°C

Operating Procedure

Release the protection before setting the PV Change Color and PV Stable Band parameters to enable moving to advanced function setting level. (Refer to steps 1 to 8 on page 108.)

Operation Level



Initial Setting Level

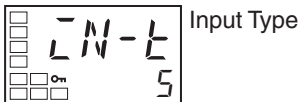

Initial Setting Level



Advanced Function Setting Level

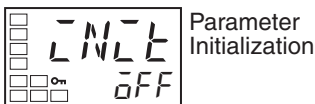

Advanced Function Setting Level

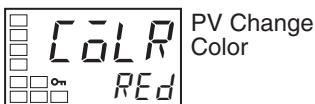

1. Press the Key for at least three seconds to move from the operation level to the initial setting level.
2. Select the Move to Advanced Function Setting Level parameter by pressing the Key.
3. Use the Key to enter “-169” (the password).
4. Select the PV Change Color parameter by pressing the Key.

Move to the advanced function setting level by pressing the Key or leaving the setting for at least two seconds.



5. Press the  Key to set the parameter to R-C.R.

Advanced Function Setting Level

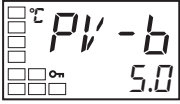

PV Stable Band

6. Select the PV Stable Band parameter by pressing the  Key.

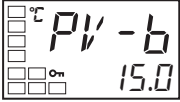

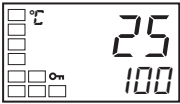

7. Use the  Key to set the parameter to 15.0.

Operation Level



PV/SP

8. To return to the initial setting level, press the  Key for at least one second.

9. To return to the operation level, press the  Key for at least one second.

4-11 Alarm Delays

4-11-1 Alarm Delays

- Delays can be set for the alarm outputs. ON and OFF delays can be set separately for alarms 1, 2, and 3. The ON and OFF delays for alarm 1 function only for the alarm function. If the alarm 1 function is set to be output as an OR with other alarms (i.e., the heater burnout alarm, HS alarm, heater overcurrent alarm, or input error output alarm), delays cannot be set for the other alarms. The ON and OFF delays for alarms 1, 2, and 3 also apply to the individual SUB1, SUB2, and SUB3 indicators and to communications status. The alarm ON delays will also function when power is turned ON or when moving from the initial setting level to operation level (e.g., to software resets). All outputs will turn OFF and the OFF delays will not function when moving to the initial setting level or when an alarm is output for a A/D converter error.

Operation of Alarm ON and OFF Delays (for an Upper-limit Alarm)

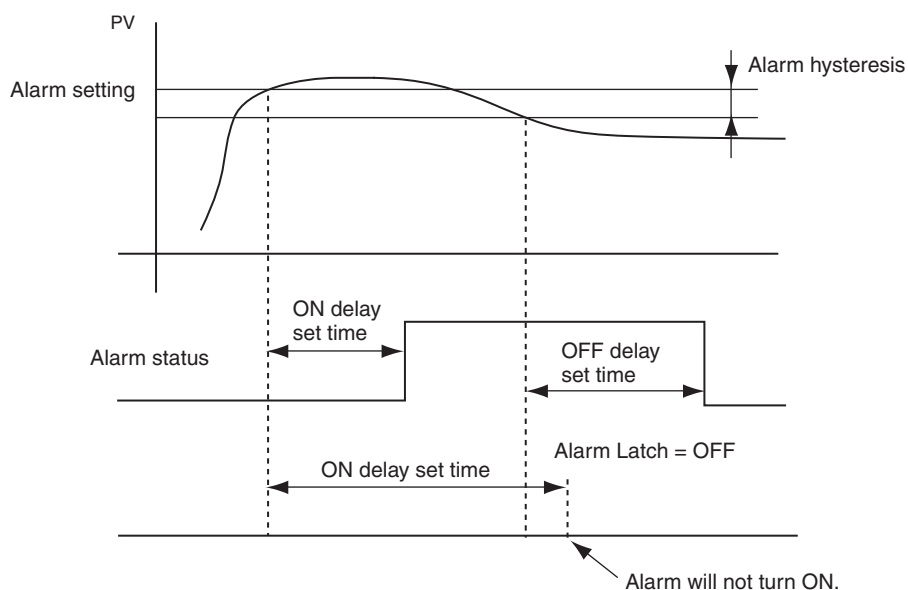

- The alarm will not turn ON if the time that the alarm is ON is equal to or less than the ON delay set time. Also, the alarm will not turn OFF if the time that the alarm is OFF is equal to or less than the OFF delay set time.
- If an alarm turns OFF and then back ON during the ON delay time, the time will be remeasured from the last time the alarm turns ON. Also, if an alarm turns ON and then back OFF during the OFF delay time, the time will be remeasured from the last time the alarm turns OFF.

Parameters Related to Alarm Delays

Parameter name	Symbol	Set (monitor) values
Alarm 1 ON Delay	$R1\bar{o}N$	0 to 999 (s)
Alarm 2 ON Delay	$R2\bar{o}N$	0 to 999 (s)
Alarm 3 ON Delay	$R3\bar{o}N$	0 to 999 (s)
Alarm 1 OFF Delay	$R1\bar{o}F$	0 to 999 (s)
Alarm 2 OFF Delay	$R2\bar{o}F$	0 to 999 (s)
Alarm 3 OFF Delay	$R3\bar{o}F$	0 to 999 (s)

- Note**
- (1) The defaults are 0, i.e., the ON and OFF delays are disabled.
 - (2) The parameters are displayed when alarm functions are assigned and when the alarm type is set to any type but 0 (none), 12: LBA, or 13: PV change rate alarm.

Operating Procedure

Use the following procedure to set ON and OFF delays for the alarm 1. An ON delay of 5 seconds and an OFF delay of 10 s will be set.

Operation Level



Initial Setting Level

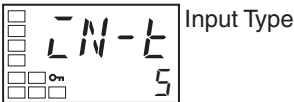

1. Press the Key for at least three seconds to move from the operation level to the initial setting level.

Initial Setting Level



2. Select the Move to Advanced Function Setting Level parameter by pressing the Key. (For details on moving between levels, refer to 4-8 Moving to the Advanced Function Setting Level.)

Advanced Function Setting Level

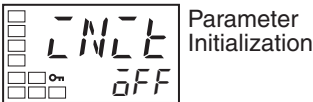

3. Press the Key to enter the password (-169) and move from the initial setting level to the advanced function setting level.

Advanced Function Setting Level

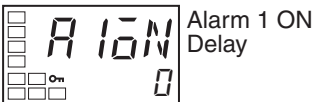

4. Press the Key to select the Alarm 1 ON Delay parameter.



5. Press the Key to set the parameter to 5.

Advanced Function Setting Level



6. Press the Key to select the Alarm 1 OFF Delay parameter.



7. Press the Key to set the parameter to 10.

Initial Setting Level

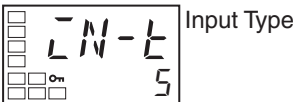

8. Press the Key for at least one second to move from the advanced function setting level to the initial setting level.

Operation Level



9. Press the Key for at least one second to move from the initial setting level to the operation level.

4-12 Loop Burnout Alarm

4-12-1 Loop Burnout Alarm (LBA)

- With a loop burnout alarm, there is assumed to be an error in the control loop if the control deviation ($SP - PV$) is greater than the threshold set in the LBA Level parameter and if the control deviation is not reduced by at least the value set in the LBA Detection Band parameter within the LBA detection time.
- Loop burnout alarms are detected at the following times.

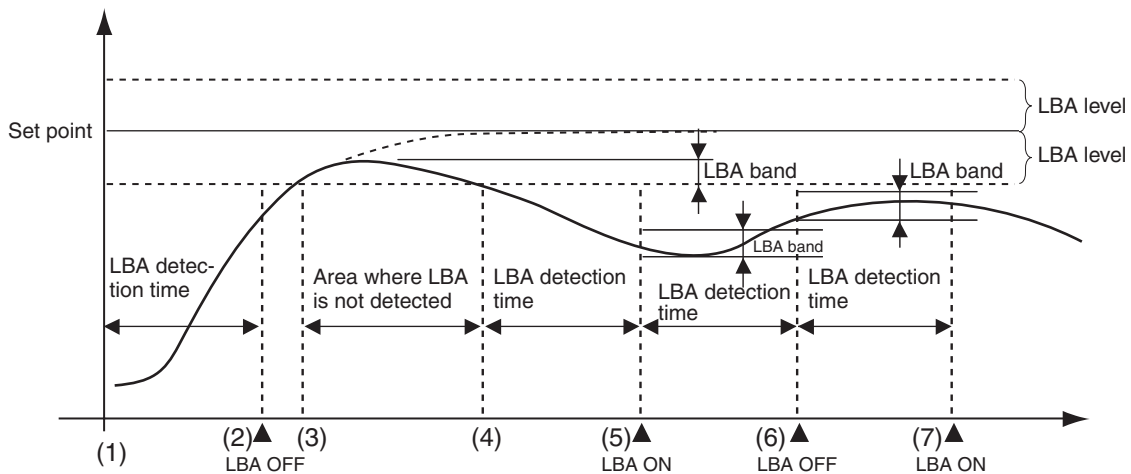

If the control deviation is reduced in the area between 1 and 2 (i.e., the set point is approached) and the amount the control deviation is reduced is at least equal to the LBA band, the loop burnout alarm will remain OFF.

The process value is within the LBA level between 3 and 4, and thus loop burnout alarms will not be detected. (The loop burnout alarm will remain OFF.)

If the process value is outside the LBA level between 4 and 5 and the control deviation is not reduced by at least the LBA band within the LBA detection time, the loop burnout alarm will turn ON.

If the control deviation is reduced in the area between 5 and 6 (i.e., the set point is approached) and the amount the control deviation is reduced is at least equal to the LBA band, the loop burnout alarm will turn OFF.

If the control deviation is reduced in the area between 6 and 7 (i.e., the set point is approached) and the amount the control deviation is reduced is less than the LBA band, the loop burnout alarm will turn ON.

- If the LBA detection time, LBA level, LBA detection band, and PID settings are not appropriate, alarms may be detected inappropriately or alarms may not be output when necessary.
- Loop burnout alarms may be detected if unexpectedly large disturbances occur continuously and a large deviation does not decrease.
- If a loop burnout occurs when the set point is near the ambient temperature, the temperature deviation in a steady state may be less than the LBA level, preventing detection of the loop burnout.

- If the set point is so high or low that it cannot be reached even with a saturated manipulated variable, a temperature deviation may remain even in a steady state and a loop burnout may be detected.
- Detection is not possible if a fault occurs that causes an increase in temperature while control is being applied to increase the temperature (e.g., an SSR short-circuit fault).
- Detection is not possible if a fault occurs that causes a decrease in temperature while control is being applied to decrease the temperature (e.g., a heater burnout fault).

Parameters Related to Loop Burnout Alarms

Parameter name	Symbol	Setting range		Remarks
LBA Detection Time	<i>LbA</i>	0 to 9999 (s)		Setting 0 disables the LBA function.
LBA Level	<i>LbAL</i>	Controllers with Thermocouple/Resistance Thermometer Universal Inputs	0.1 to 999.9 (°C/°F) (See note.)	Default: 8.0 (°C/°F)
		Controllers with Analog Inputs	0.01 to 99.99 (%FS)	Default: 10.00% FS
LBA Band	<i>LbAb</i>	Controllers with Thermocouple/Resistance Thermometer Universal Inputs	0.0 to 999.9 (°C/°F) (See note.)	Default: 3.0 (°C/°F)
		Controllers with Analog Inputs	0.00 to 99.99 (%FS)	Default: 0.20% FS

Note Set “None” as the unit for analog inputs.

- A loop burnout alarm can be output by setting the alarm 1 type to 12 (LBA).
- A setting of 12 (LBA) can be set for alarm 2 or alarm 3, but the setting will be disabled.
- Loop burnouts are not detected during SP ramp operation.
- Loop burnouts are not detected during auto-tuning, manual operation, or while stopped.
- If the alarm 1 latch is set to ON, the latch will be effective for the loop burnout alarm.
- The LBA detection time is automatically set by auto-tuning. (It is not set automatically, however, for heating/cooling control.)
- If the optimum LBA detection time is not obtained by auto-tuning, set the LBA Detection Time parameter (advanced function setting level).

Automatically Setting the LBA Detection Time

Determining the LBA Detection Time

1,2,3...

- To manually set the LBA detection time, set the LBA Detection Time parameter to twice the LBA reference time given below.
- Set the output to the maximum value.
 - Measure the time required for the width of change in the input to reach the LBA band.

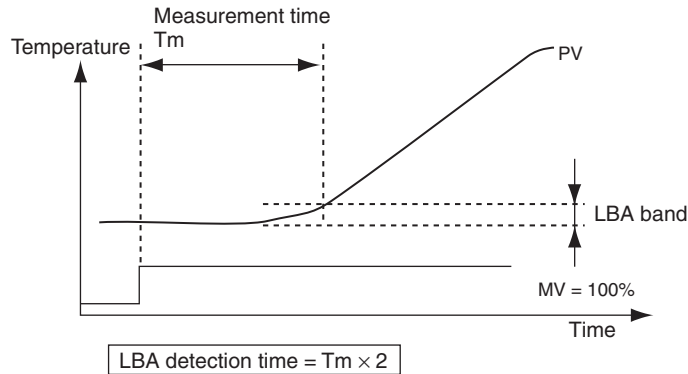

- Set the LBA Detection Time parameter to two times the measured time.

LBA Level

- Set the control deviation when the control loop is working properly.
- The default is 8.0 (°C/°F) for Controllers with Thermocouple/Resistance Thermometer Universal Inputs and 10.00% FS for Controllers with Analog Inputs.

LBA Band

- There is assumed to be an error in the control loop if the control deviation is greater than the threshold set in the LBA Level parameter and if the control deviation does not change by at least the value set in the LBA Band parameter.
- The default is 3.0 (°C/°F) for Controllers with Thermocouple/Resistance Thermometer Universal Inputs and 0.20% FS for Controllers with Analog Inputs.

Operating Procedure

Perform the following procedure to use the loop burnout alarm. In this example, the LBA detection time is set to 10, the LBA level is set to 8.0, and the LBA band is set to 3.0.

Operation Level



Initial Setting Level

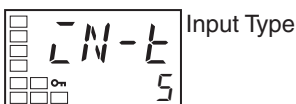

Initial Setting Level

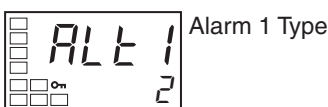

- Press the Key for at least three seconds to move from the operation level to the initial setting level.
- Select the Alarm 1 Type parameter by pressing the Key.

Initial Setting Level



3. Press the Key to set the parameter to 12.



Move to Advanced Function Setting Level

4. Select the Move to Advanced Function Setting Level parameter by pressing the Key. (For details on moving between levels, refer to 4-8 Moving to the Advanced Function Setting Level.)

Advanced Function Setting Level

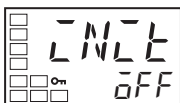

Parameter Initialization

5. Press the Key to enter the password (-169), and move from the initial setting level to the advanced function setting level.

Advanced Function Setting Level

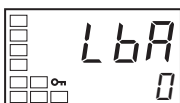

LBA Detection Time

6. Select the LBA Detection Time parameter by pressing the Key.

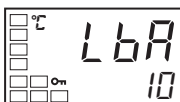

7. Press the Key to set the parameter to 10.

Advanced Function Setting Level

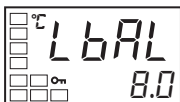

LBA Level

8. Select the LBA Level parameter by pressing the Key.

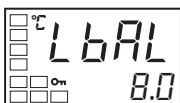

9. Press the Key to set the parameter to 8.0. (The default is 8.0.)

Advanced Function Setting Level

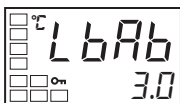

LBA Band

10. Select the LBA Band parameter by pressing the Key.

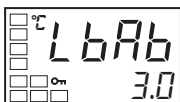

11. Press the or Key to set the parameter to 3.0. (The default is 3.0.)

Initial Setting Level

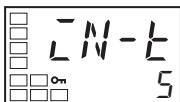

Input Type

12. Press the Key for at least one second to move from the advanced function setting level to the initial setting level.

Operation Level

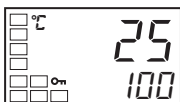

PV/SP

13. Press the Key for at least one second to move from the initial setting level to the operation level.

4-13 Performing Manual Control

4-13-1 Manual Operation

- The manipulated variable can be set in manual mode if the PV/MV parameter is displayed in the manual control level. The final MV used in automatic mode will be used as the initial manual MV when moving from automatic mode to manual mode. In manual mode, the change value will be saved immediately and reflected in the actual MV.
- The automatic display return function will not operate in manual mode.
- Balanceless-bumpless operation will be performed for the MV when switching from manual operation to automatic operation. (See note.)
- If a power interruption occurs during manual operation, manual operation will be restarted when power is restored using the same MV as when power was interrupted.
- Switching between automatic and manual operation is possible for a maximum of one million times.
- Manual operation can be used only for PID control.

Note In balanceless-bumpless operation, the MV before switching is used initially after the switch and then gradually changed to achieve the proper value after switch to prevent radical changes in the MV after switching operation.

The overall manual operation is illustrated in the following figure.

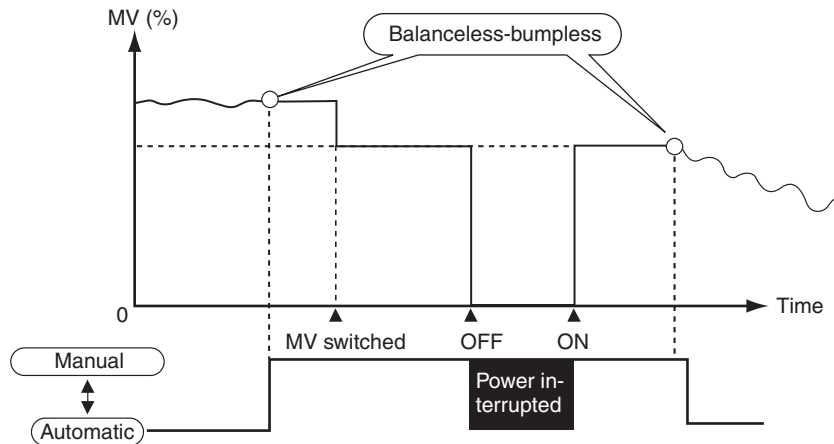

Related Displays and Parameters

Parameter name	Symbol	Level	Remarks
PV/MV (Manual MV)	---	Manual Control Level	-5.0 to 105.0 (heating/cooling control: -105.0 to 105.0 (See note 2.))
Auto/Manual Switch	<i>A-M</i>	Operation Level	Switches between automatic and manual modes.
Auto/Manual Select Addition	<i>AMAd</i>	Advanced Function Setting Level	Enables switching between automatic and manual modes.



- Note**
- (1) Refer to 4-16 Output Adjustment Functions for information on the priority for the MV.
 - (2) For Manual MV Limit Enable, this value will be between the MV upper limit and the MV lower limit.

Manual MV Limit Enable

When the Manual MV Limit Enable parameter is set to ON (enabled), the MV limits will function and the setting range for the Manual MV parameter will be between the MV upper limit and the MV lower limit. When the parameter is set to OFF (disabled), MV limits will not function.

Parameter name	Setting range	Default
Manual MV Limit Enable	OFF: Disabled, ON: Enabled	ON

Moving from the Operation Level to the Manual Control Level

- When the  Key is pressed for at least 3 seconds in the operation level's auto/manual switching display, the manual mode will be entered and the manual control level will be displayed. It is not possible to move to any displays except for the PV/MV parameter during manual operation. Press the  Key for at least one second from the PV/MV parameter display in manual control level to return to automatic mode and display the top parameter in the operation level.

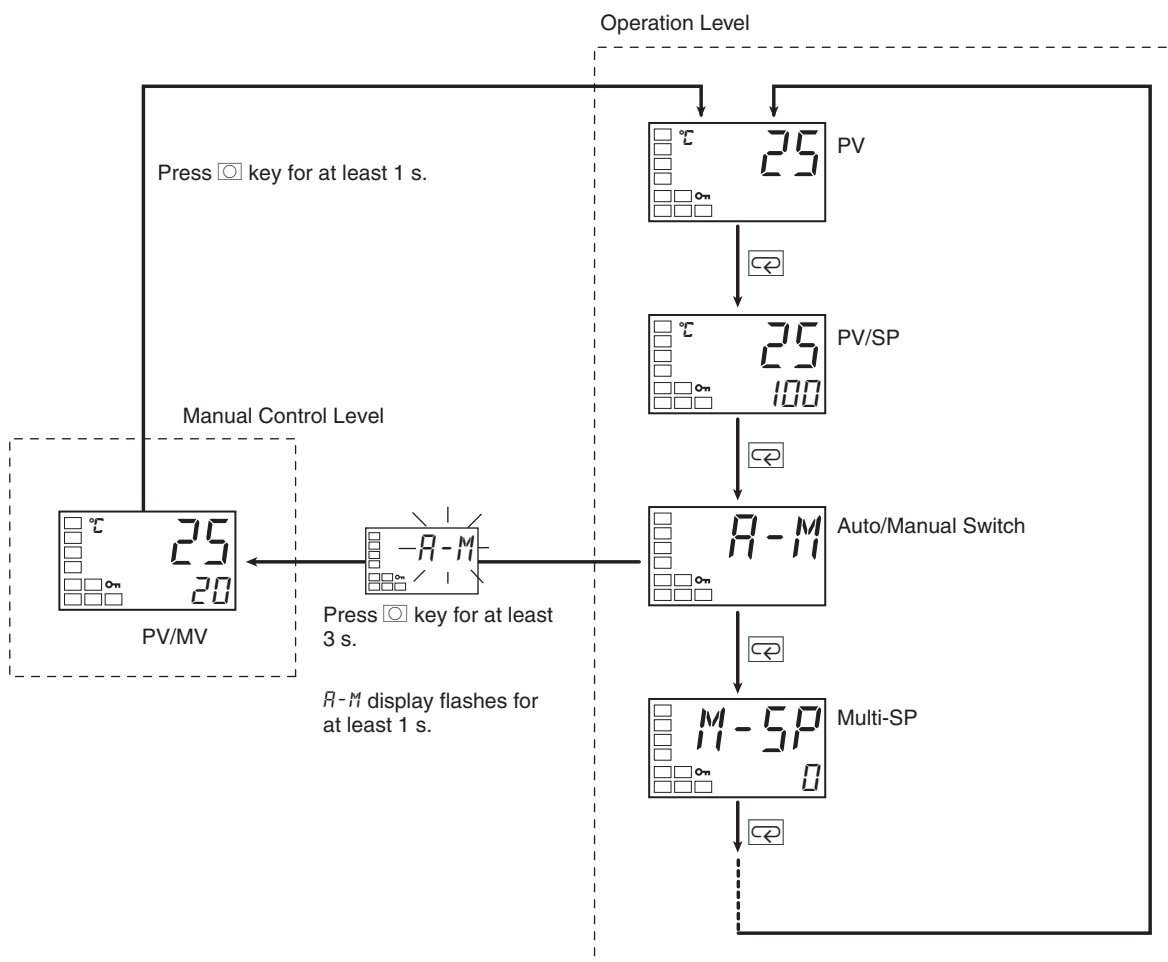

- If an event input is set to MANU (auto/manual), the Auto/Manual Switch parameter will not be displayed. Use the event input to switch between automatic and manual modes.

Using the PF Key to Move to the Manual Control Level

- When the PF Setting parameter is set to A-M (Auto/Manual), pressing the PF Key for at least one second while in the adjustment or operation level will change the mode to manual mode and move to the manual control level. During manual operation it is not possible to move to any displays other than PV/MV (Manual MV). Press the PF Key for at least one second from the PV/MV display in the manual control mode to change the mode to automatic mode, move to the operation level, and display the top parameter in the operation level.
- When MANU (Auto/Manual) is selected for an event input, the Auto/Manual Switch parameter is not displayed. In that case, switching between auto and manual mode is executed by using an event input.

Auto/Manual Select Addition

- The Auto/Manual Select Addition parameter must be set to ON in the advanced function setting level before it is possible to move to manual mode. The default is OFF.

Note

- (1) Priority of Manual MV and Other Functions
Even when operation is stopped, the manual MV is given priority. Auto-tuning and self-tuning will stop when manual mode is entered.
- (2) Manual MV and SP Ramp
If operating, the SP ramp function will continue even when manual mode is entered.

Operating Procedure

Use the following procedure to set the manipulated variable in manual mode.

Operation Level



Initial Setting Level

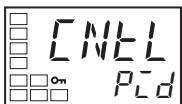
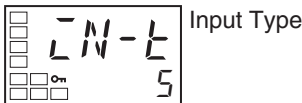

Initial Setting Level



Advanced Function Setting Level

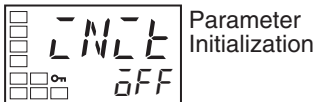

Advanced Function Setting Level



1. Press the Key for at least three seconds to move from the operation level to the initial setting level.
2. Press the Key to select PID-ON/OFF and then select PID with the Key.
3. Select the Move to Advanced Function Setting Level parameter by pressing the Key. (For details on moving between levels, refer to 4-8 Moving to the Advanced Function Setting Level.)
4. Press the Key to enter the password (-169), and move from the initial setting level to the advanced function setting level.
5. Select the Auto/Manual Select Addition parameter by pressing the Key.



Initial Setting Level

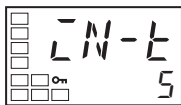

Input Type

Operation Level

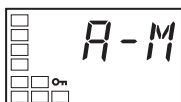

Auto/Manual Switch

Manual Control Level

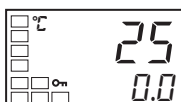

PV/MV

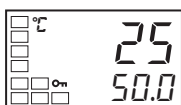

Operation Level

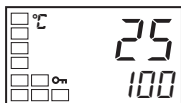

PV/SP

Operating Procedure

6. Use the Key to set the parameter to ON.
7. Press the Key for at least one second to move from the advanced function setting level to the initial setting level.
8. Press the Key for at least one second to move from the initial setting level to the operation level.
9. Select the Auto/Manual Switch parameter by pressing the Key.
10. Press the Key for at least three seconds to move from the operation level to the manual control level.
11. Press the or Key to set the manual MV. (In this example, the MV is set to 50.0%.)
12. Press the Key for at least one second to move from the manual control level to the operation level.

Note The manual MV setting must be saved (see page 18), but values changed with Key operations are reflected in the control output immediately.

Operation Level

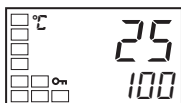

PV/SP

Initial Setting Level

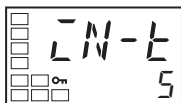

Input Type

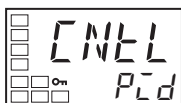

Initial Setting Level



Move to Advanced Function Setting Level

In this example, A-M (Auto/Manual) is set for the PF Setting parameter (E5AN/EN only).

1. Press the Key for at least three seconds to move from the operation level to the initial setting level.
2. Press the Key to select PID-ON/OFF and then select PID with the Key.
3. Select the Move to Advanced Function Setting Level parameter by pressing the Key. (For details on moving between levels, refer to 4-8 Moving to the Advanced Function Setting Level.)

Advanced Function Setting Level

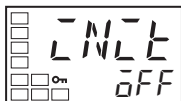

Parameter Initialization

4. Press the Key to enter the password (-169), and move from the initial setting level to the advanced password setting level.

Advanced Function Setting Level



Auto/Manual Select Addition

5. Select the Auto/Manual Select Addition parameter by pressing the Key.



6. Use the Key to set the parameter to ON.

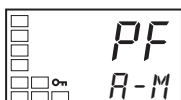

7. Press the Key to select the PF Setting parameter and confirm that it is set to "A-M." ("A-M" is the default setting.)

Initial Setting Level

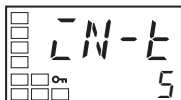

Input Type

8. Press the Key for at least one second to move from the advanced function setting level to the initial setting level.

9. Press the Key for at least one second to move from the initial setting level to the operation level.

Manual Control Level

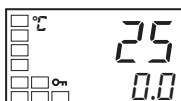

PV/MV

10. Press the PF Key for at least one second to move from the operation level to the manual control level.

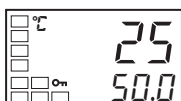

11. Press the or Key to set the manual MV. (In this example, the MV is set to 50.0%.)

Note The manual MV setting must be saved (see page 18), but values changed with key operations are reflected in the control output immediately.

Operation Level

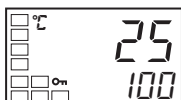

ALM

12. Press the PF Key to move from the manual control level to the operation level.

4-14 Using the Transfer Output

4-14-1 Transfer Output Function

- To use a transfer output, change the setting for the Transfer Type parameter to anything other than OFF. (This will enable the Transfer Output Upper Limit and Transfer Output Lower Limit parameters.)

- The operation is shown in the following table.

Control output 1	Control output 2	Transfer output destination
Current output	None, relay output, voltage output (for driving SSR)	Control output 1
Relay output, voltage output (for driving SSR)	None, relay output, voltage output (for driving SSR)	None

■ Precision and User Calibration

	Precision	User calibration
Simple transfer output	Not specified.	Not supported.

Transfer Output Type

Transfer output type	Symbol	Setting range
OFF (See note 1.)	$\bar{a}FF$	---
Set point	SP	SP lower limit to SP upper limit
Set point during SP ramp	$SP-M$	SP lower limit to SP upper limit
PV	PV	Input setting range lower limit to input setting range upper limit or Scaling lower limit to scaling upper limit
MV monitor (heating)	MV	-5.0 to 105.0 (heating/cooling control: 0.0 to 105.0) (See note 2.)
MV monitor (cooling)	$\bar{L}-MV$	0.0 to 105.0 (See note 2.)

Note

- The default is OFF.
- The output value will be different between when the Transfer Output Type parameter is set to a heating control output or cooling control output, and when the Control Output 1 Assignment parameter is set to a heating control output or cooling control output.

Example: When a Current Output Is Set to 4 to 20 mA and MV Monitor (Heating) Is Selected

When used as a transfer output, 4.0 mA will be output for 0% and 20.0 mA will be output for 100%.

When used as a control output, 3.7 mA will be output for 0% and 20.3 mA will be output for 100% so that the actuator is controlled at 0% or 100%.

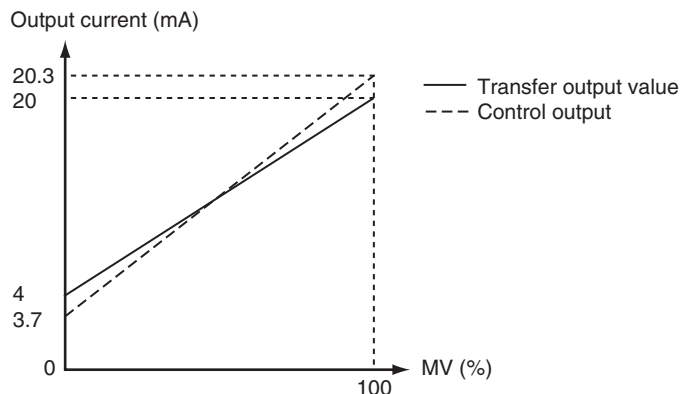

(The above graph is for when the linear current output type is set to 4 to 20 mA.)

Transfer Scaling

- Reverse scaling is possible by setting the Transfer Output Lower Limit parameter larger than the Transfer Output Upper Limit parameter. If the Transfer Output Lower Limit and Transfer Output Upper Limit parameters are set to the same value when 4 to 20 mA is set, the transfer output will be output continuously at 0% (4 mA).
- If the SP, SP during SP ramp, or PV is selected, the Transfer Output Lower Limit and Transfer Output Upper Limit parameters will be forcibly initialized to the respective upper and lower setting limits for changes in the upper and lower limits of the SP limiter and the temperature unit. If the MV for heating or MV for cooling is selected, the Transfer Output Lower Limit and Transfer Output Upper Limit parameters will be initialized to 100.0 and 0.0, respectively, when a switch is made between standard control and heating/cooling control using the Standard or Heating/Cooling parameter.
- The output current when the linear current type is set to 4 to 20 mA, the transfer output upper limit is set to 90.0, and the transfer output lower limit is set to 10.0 is shown in the following graph.
- For scaling from 0.0% to 100.0%, the output for -5.0 to 0.0 will be the same value as for 0.0%, and the output for 100.0 to 105.0 will be the same value as for 100.0%

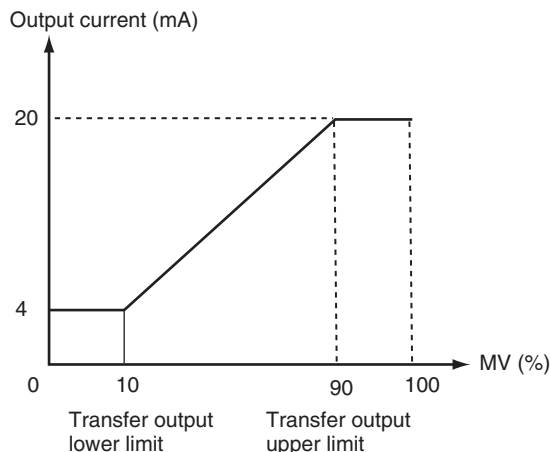

(The above graph is for when the linear current output type is set to 4 to 20 mA.)

Operating Procedure

The following procedure sets the transfer output for an SP range of -50 to 200.

Operation Level



Initial Setting Level

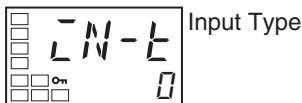

Initial Setting Level

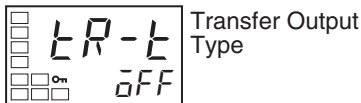

1. Press the Key for at least three seconds to move from the operation level to the initial setting level.
2. Select the Transfer Output Type parameter by pressing the Key.

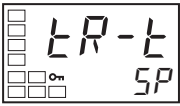

Initial Setting Level

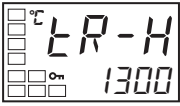

Transfer Output Upper Limit

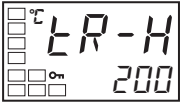

Initial Setting Level

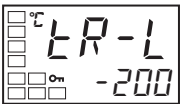

Transfer Output Lower Limit

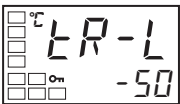

Operation Level

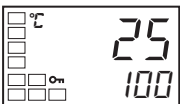

PV/SP

3. Press the Key to select SP (set point).
4. Select the Transfer Output Upper Limit parameter by pressing the Key.
5. Use the Key to set the parameter to 200. The default is 1300.
6. Select the Transfer Output Lower Limit parameter by pressing the Key.
7. Use the Key to set the parameter to -50. The default is -200.
8. To return to the operation level, press the Key for at least one second.

4-15 Using the Simple Program Function

4-15-1 Simple Program Function

- The simple program function can be used for the following type of control.

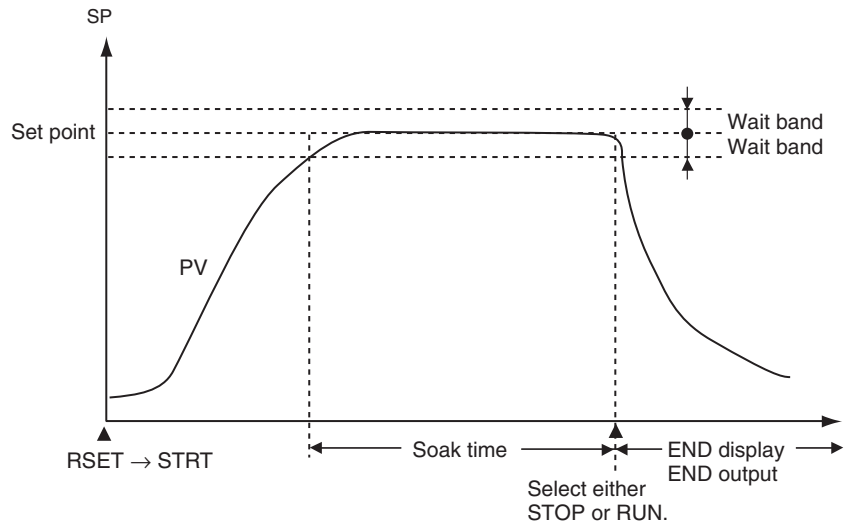

- The program will start when the Program Start parameter is changed from RSET to STRT. END will be displayed on the No. 2 display and the output assigned as the program end output will turn ON after the time set in the Soak Time parameter has expired in the wait band. The Program Pattern parameter can be used to select moving to STOP mode or continuing operation in RUN mode after the program ends.

Parameters Related to the Simple Program Function

Parameter name	Symbol	Set (monitor) values	Unit	Display level
Program Pattern	<i>PERN</i>	OFF, STOP, CONT	---	Initial setting level
Program Start	<i>PRSE</i>	RSET, STRT	---	Operation level
Soak Time	<i>SOAK</i>	1 to 9999	min or h	Adjustment level
Soak Time Unit	<i>t-U</i>	m (minutes)/h (hours)	---	Advanced function setting level
Wait Band	<i>WT-b</i>	OFF or 0.1 to 999.9 (See note 2.)	°C or °F (See notes 1 and 2.)	Adjustment level
Soak Time Remain Monitor	<i>SKLR</i>	0 to 9999	min or h	Operation level

- Note**
- (1) Set for Controllers with Thermocouple/Resistance Thermometer Universal Inputs. Set “None” as the unit for Controllers with Analog Inputs.
 - (2) The setting unit of the Wait Band parameter is %FS for Controllers with Analog Inputs and the setting range is OFF or 0.01 to 99.99.

Program Pattern

Either of two program patterns can be selected. The simple program operation will not be performed if the Program Pattern parameter is set to OFF.

■ **Pattern 1 (STOP)**

Control will stop and the STOP mode will be entered when the program has ended.

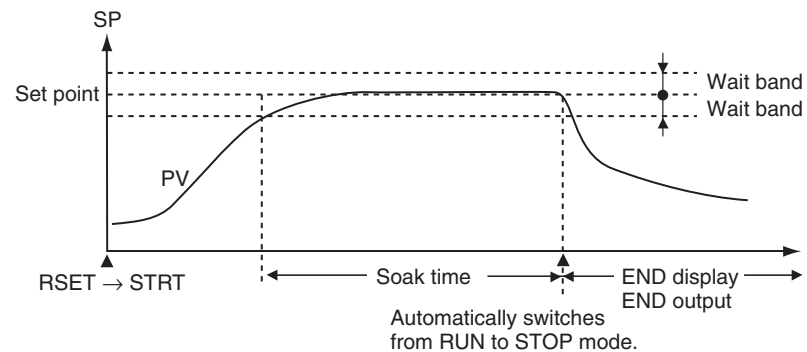

■ **Pattern 2 (CONT)**

Control will continue in RUN mode when the program has ended.

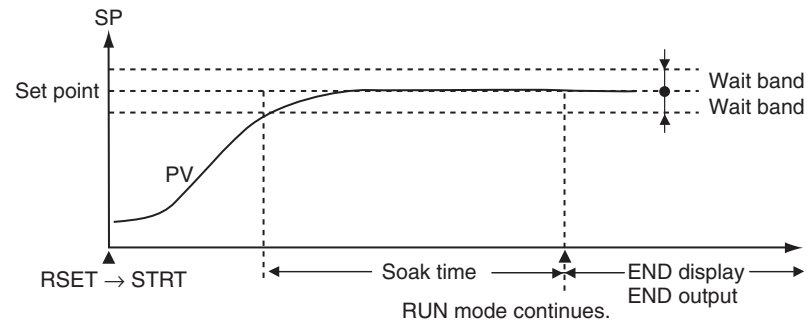

Starting Method

Any of the following three methods can be used to start the simple program.

- Setting the Program Start parameter to STRT.
- Turning ON an event input. (The program start must be assigned to an event input. See note.)
- Starting with an Operation Command using communications. (When the program start is not assigned to an event input.)

Note When the simple program is started and reset, writing is performed to EEPROM. Be sure to consider the write life (1 million writes) of the EEPROM in the system design. When the program start is assigned to an event input, the Program Start parameter will function as a monitor display, and the RSET/STRT displays can be used to check when the event input has started or reset the simple program. When this is done, the Program Start parameter functions as a monitor display only and cannot be changed using key operations. If the Program Pattern parameter is set to OFF, the event input assignment setting will be initialized to "None."

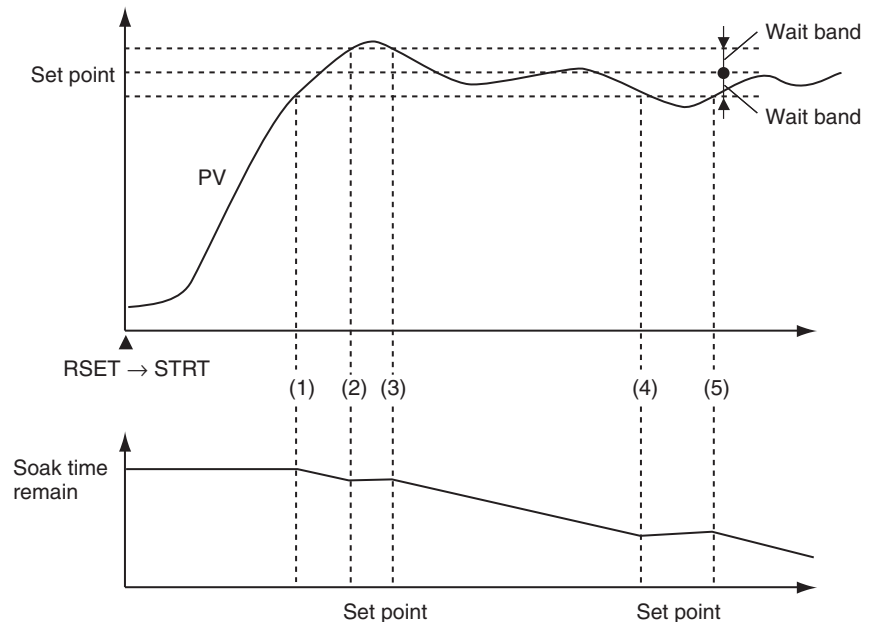
Soak Time and Wait Band

The wait band is the band within which the process value is stable in respect to the set point. The soak time is measured within the wait band. The timer that measures the soak time operates only when the process value is within the wait band around the set point (i.e., $SP \pm \text{wait band}$). In the following diagram, the timer will be stopped between the start and (1), (2) and (3), and (4) and (5) and will measure the time only between (1) and (2), (3) and (4), and (5) and the end.

Note If the wait band is set to OFF, the wait band will be treated as infinity and the timer will measure time continuously after changing from RSET to STRT.

4-15-2 Operation at the Program End

Display at the Program End

When the program ends, the process value will be displayed on the No. 1 display (see note) and the set point and “end” will be alternately displayed on the No. 2 display at 0.5 s intervals.

Note One of the following displays: PV/SP, PV only, or PV/MV.

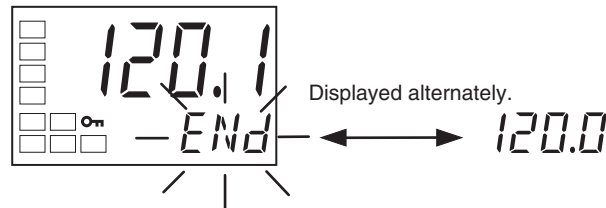

Program End Output

The output assignment parameters can be used to assign the program END output to any output. The program END output can also be used in communications status.

E5CN/CN-U, E5AN/EN

When the Program Pattern parameter is changed from OFF to STOP or CONT for the E5CN, E5CN-U, E5AN, or E5EN, the Auxiliary Output 1 Assignment parameter will automatically be set to the END output. When the Program Pattern parameter is changed from STOP or CONT to OFF, the Alarm 1 Output Assignment parameter will automatically be initialized to ALM1.

E5GN

When the Program Pattern parameter is changed from OFF to STOP or CONT for the E5GN, the Auxiliary Output 1 Assignment parameter will automatically be set to the END output. When the Program Pattern parameter is changed from STOP or CONT to OFF, the Alarm 1 Output Assignment parameter will automatically be initialized to ALM1. When using heating/cooling control and the Program Pattern parameter is changed from OFF to STOP or CONT, the END output will not be assigned to an output. Use the output assignment parameters to assign the program END output to the desired output.

Clearing the Program End Status

The program END output and display will be cleared when the Program Start parameter is changed from STRT to RSET. The setting is changed from STRT to RSET while the Program Start parameter is displayed.

The program END status can also be cleared using an event. If the program start function is assigned to an event, however, the program end status cannot be cleared from the Program Start parameter display, which will function only as a monitor display.

Operating Procedure

Perform the following procedure to use the simple program function.

In this example, the program pattern will be set to STOP, the soak time to 10 min, and the wait band to 3.

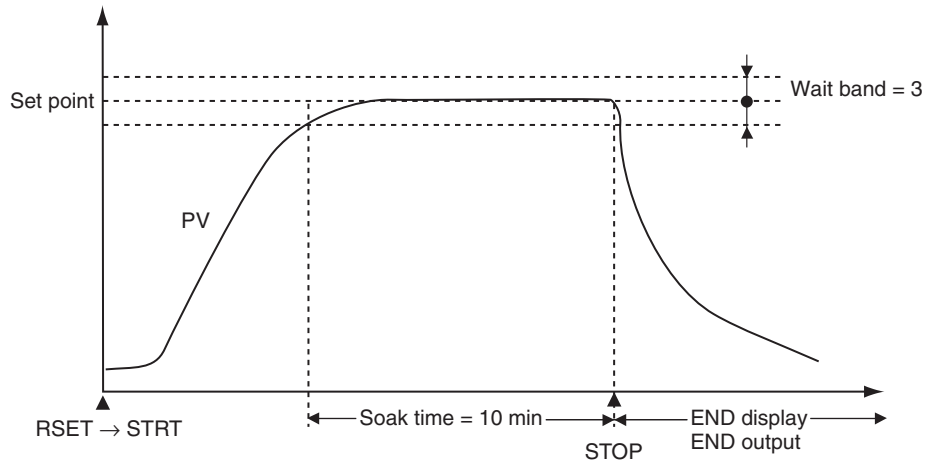

Operation Level



Initial Setting Level

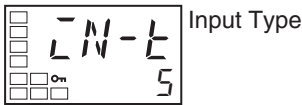

Initial Setting Level



Operation Level



Adjustment Level



Adjustment Level

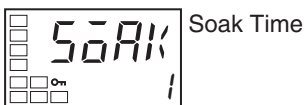

1. Press the Key for at least three seconds to move from the operation level to the initial setting level.
2. Select the Program Pattern parameter by pressing the Key.
3. Use the Key to set the parameter to STOP.
4. Press the Key for at least one second to move from the initial setting level to the operation level.
5. Press the Key to move from the operation level to the adjustment level.
6. Select the Soak Time parameter by pressing the Key.
7. Use the Key to set the parameter to 10. (The soak time unit is set in Soak Time Unit parameter in the advanced function setting level. The default is M (minutes).

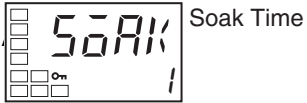

Soak Time

6. Select the Soak Time parameter by pressing the  Key.



7. Use the  Key to set the parameter to 10. (The soak time unit is set in Soak Time Unit parameter in the advanced function setting level. The default is *M* (minutes).

4-15-3 Application Example Using a Simple Program

The program will be started by changing the setting of the Program Start parameter. The following example shows using a simple program with the program pattern set to STOP.

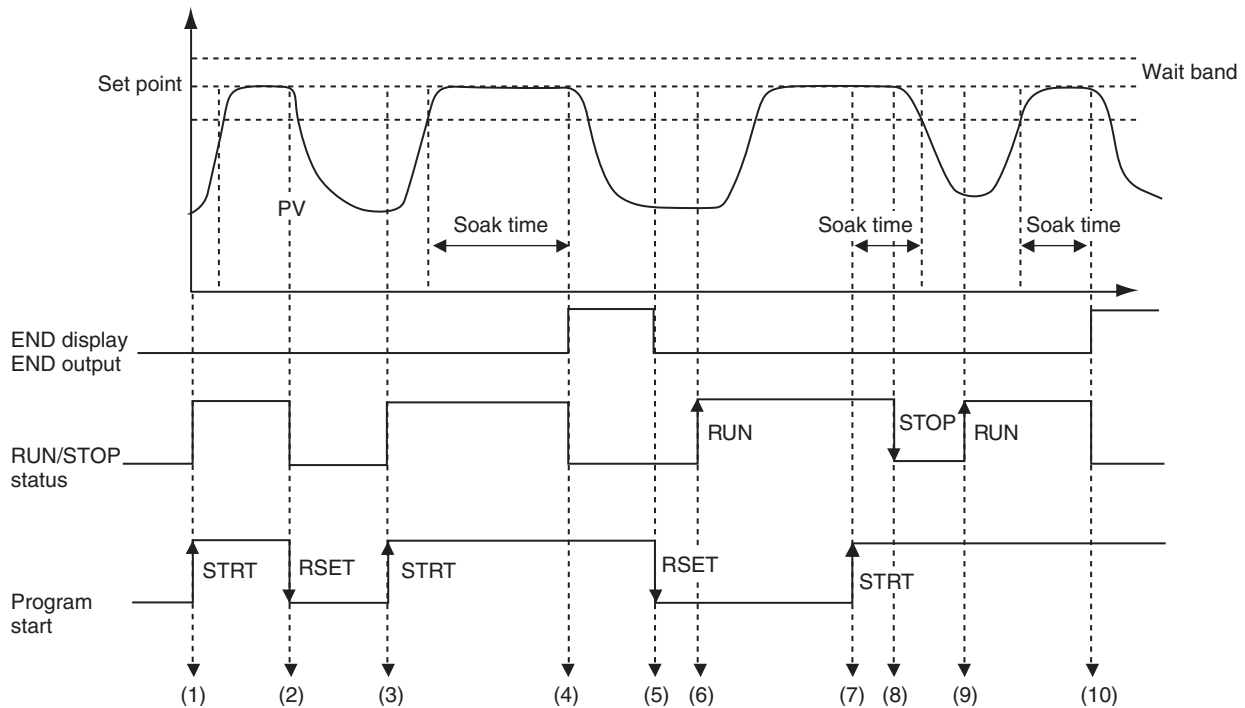

Timing	Description
(1)	<ul style="list-style-type: none"> The Program Start parameter was changed from RSET to STRT using either an event or key operations. The RUN/STOP status automatically changes to RUN mode when the above operation is performed.
(2)	<ul style="list-style-type: none"> The Program Start parameter was changed from STRT to RSET using either an event or key operations before the soak time expired. The RUN/STOP status automatically changes to STOP mode when the above operation is performed.
(3)	<ul style="list-style-type: none"> The Program Start parameter is again changed from RSET to STRT using either an event or key operations. The RUN/STOP status will automatically change to RUN mode when the above operation is performed.
(4)	<ul style="list-style-type: none"> The RUN/STOP status automatically changes to STOP mode when soak time expires. END flashes on the No. 2 display and the program END output turns ON.
(5)	<ul style="list-style-type: none"> The Program Start parameter is changed from STRT to RSET using either an event or key operations. The END display is cleared and the program END output turns OFF.
(6)	<ul style="list-style-type: none"> Key operations are used to switch the RUN/STOP status to RUN with the Program Start parameter set to RSET (stopped). Normal control operation is started.
(7)	<ul style="list-style-type: none"> The Program Start parameter is changed from RSET to STRT after the process value stabilizes. The RUN/STOP status remains as RUN.
(8)	<ul style="list-style-type: none"> Key operations are used to change the RUN/STOP status to STOP (during program operation). Measuring the soak time is continued within the wait band. (Measuring the soak time stops when the process value leaves the wait band.)
(9)	<ul style="list-style-type: none"> Key operations are used to change the RUN/STOP status to RUN. Measuring the soak time is continued within the wait band (continuing from the time between (7) and (9)).
(10)	<ul style="list-style-type: none"> The RUN/STOP status automatically changes to STOP mode when the measured time reaches the soak time. END flashes on the No. 2 display and the program END output turns ON.

4-16 Output Adjustment Functions

4-16-1 Output Limits

- Output limits can be set to control the output using the upper and lower limits to the calculated MV.
- The following MV takes priority over the MV limits.
Manual MV (See note.)
MV at stop
MV at PV error

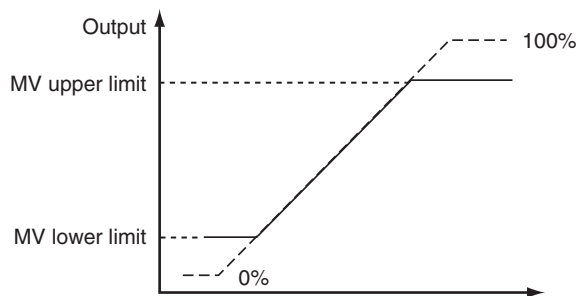

Note When the manual MV limit is enabled, the manual MV will be restricted by the MV limit.

- For heating/cooling control, upper and lower limits are set of overall heating/cooling control. (They cannot be set separately for heating/cooling.)

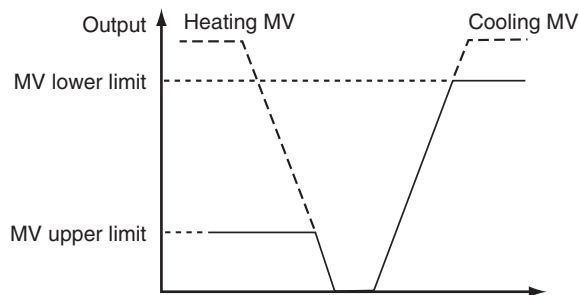

4-16-2 MV at Stop

- The MV when control is stopped can be set.
For heating/cooling control, the MV at stop will apply to the cooling side if the MV is negative and to the heating side if the MV is positive.
When setting the MV when control is stopped, set the MV at Stop and Error Addition parameter (advanced function setting level) to ON.
The default is 0.0, so an MV will not be output for either standard or heating/cooling control.

Parameter name	Setting range	Unit	Default
MV at STOP	-5.0 to 105.0 for standard control -105.0 to 105.0 (heating/cooling control)	%	0.00

Note The order of priority is as follows: Manual MV > MV at stop > MV at PV error.

4-16-3 MV at PV Error

- The MV to be output for input errors can be set. The MV at stop takes priority when stopped and the manual MV takes priority in manual mode.

Parameter name	Setting range	Unit	Default
MV at PV ERROR	-5.0 to 105.0 for standard control -105.0 to 105.0 (heating/cooling control)	%	0.0

Note The order of priority is as follows: Manual MV > MV at stop > MV at PV error.

- The order of priority of the MVs is illustrated in the following diagram.

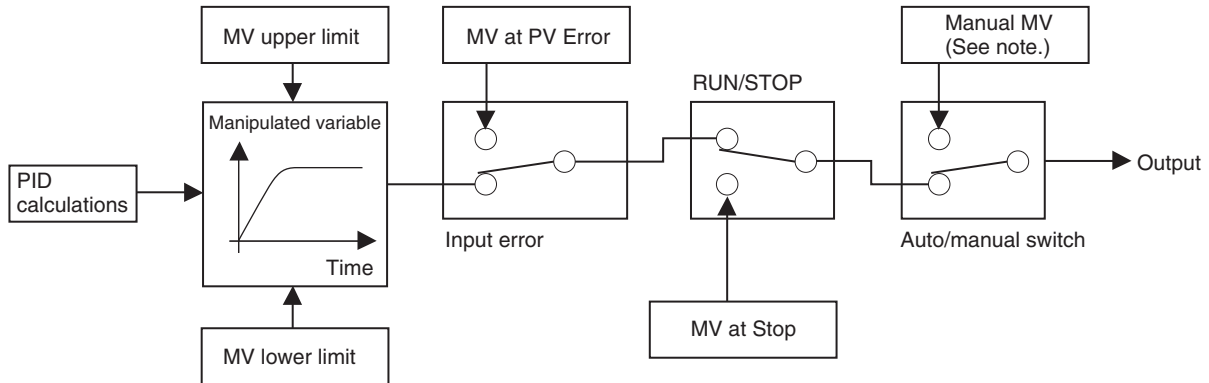

Note When the Manual MV Limit Enable parameter is set to ON, the setting range will be the MV lower limit to the MV upper limit.

4-17 Using the Extraction of Square Root Parameter

Extraction of Square Roots

Extraction of Square Root Enable



Extraction of Square Root Low-cut Point

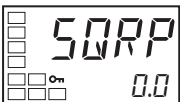

- For analog inputs, the Extraction of Square Root parameter is provided for inputs so that differential pressure-type flow meter signals can be directly input.
- The default setting for the Extraction of Square Root parameter is OFF. The Extraction of Square Root Enable parameter must be set to ON in order to use this function.
- If the PV input (i.e., the input before extracting the square root) is higher than 0.0% and lower than the low cut point set in the Extraction of Square Root Low-Cut Point parameter, the results of extracting the square root will be 0.0%. If the PV input is lower than 0.0% or higher than 100.0%, extraction of the square root will not be executed, so the result will be equal to the PV input. The low-cut point is set as normalized data for each input, with 0.0 as the lower limit and 100.0 as the upper limit for the input setting range.

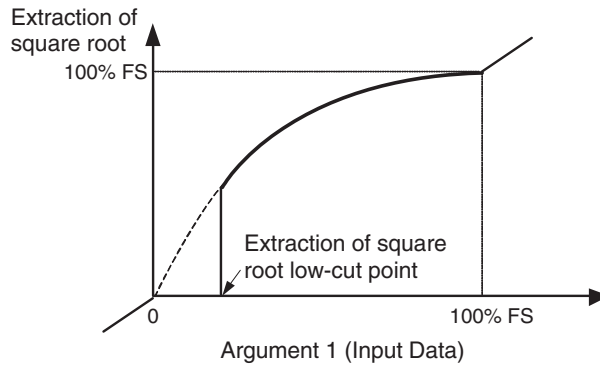

Parameter name	Setting range	Unit	Default
Extraction of Square Root Enable	OFF: Disabled, ON: Enabled	---	OFF
Extraction of Square Root Low-cut Point	0.0 to 100.0	%	0.0

Operating Procedure

This procedure sets the Extraction of Square Root Low-cut Point parameter to 10.0%.

Operation Level



Initial Setting Level

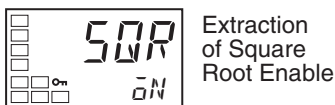
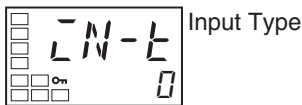

Operation Level



Adjustment Level

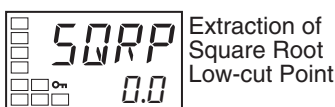
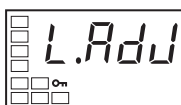

1. Press the Key for at least three seconds to move from the operation level to the initial setting level.
2. Press the Key to select the Extraction of Square Root Enable parameter.
3. Use the Key to select ON.
4. Press the Key for at least one second to move from the initial setting level to the operation level.
5. Press the Key to move from the operation level to the adjustment level.
6. Select the Extraction of Square Root Low-cut Point parameter by pressing the Key.

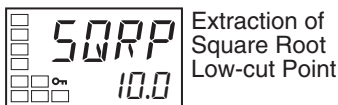

7. Use the Key to set the parameter to 10.0.

Operation Level



8. Press the Key to return to the operation level.

4-18 Setting the Width of MV Variation

MV Change Rate Limit

MV Change Rate Limit (Heating)



- The MV change rate limit sets the maximum allowable width of change in the MV per second. If the change in the MV exceeds this setting, the MV will be changed by the MV change rate limit until the calculated value is reached. This function is disabled when the setting is 0.0.
- The MV change rate limit does not function in the following situations:
 - In manual mode
 - During ST execution (Cannot be set when ST is ON.)
 - During AT execution
 - During ON/OFF control
 - While stopped (during MV at Stop output)
 - During MV at PV Error output

Parameter name	Setting range	Unit	Default
MV Change Rate Limit	0.0 to 100.0	%/s	0.0

Operating Procedure

This procedure sets the MV change rate limit to 5.0%/s. The related parameters are as follows:

PID·ON/OFF = PID

ST = OFF

Operation Level



Initial Setting Level

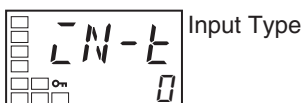

1. Press the Key for at least three seconds to move from the operation level to the initial setting level.



2. Select the PID ON/OFF parameter by pressing the Key.

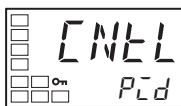

PID-ON/OFF

3. Use the Key to select 2-PID control.

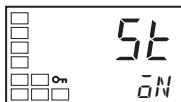

ST

4. Press the Key to select the ST parameter.

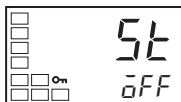

ST

5. Press the Key to select OFF.

Operation Level

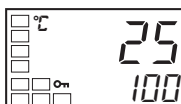

PV/SP

6. Press the Key for at least one second to move from the initial setting level to the operation level.

Adjustment Level

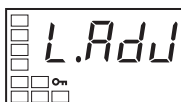

7. Press the Key to move from the operation level to the adjustment level.

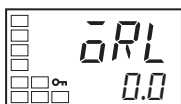

MV
Change
Rate Limit

8. Press the Key to select the MV Change Rate Limit parameter.

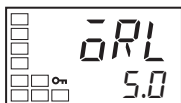

MV
Change
Rate Limit

9. Use the Key to set the parameter to 5.0.

Operation Level

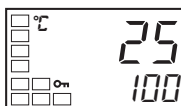

PV/SF

10. Press the Key to return to the operation level.

4-19 Setting the PF Key

4-19-1 PF Setting (Function Key)

PF Setting

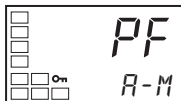

- Pressing the PF Key for at least one second executes the operation set in the PF Setting parameter (E5AN/EN only).

Set value	Symbol	Setting	Function
OFF	OFF	Disabled	Does not operate as a function key.
RUN	RUN	RUN	Specifies RUN status.
STOP	STOP	STOP	Specifies STOP status.
R-S	R-S	RUN/STOP reverse operation	Specifies reversing the RUN/STOP operation status.
AT-2	AT-2	100% AT Execute/Cancel	Specifies reversing the 100% AT Execute/Cancel status. (See note 1.)
AT-1	AT-1	40% AT Execute/Cancel	Specifies reversing the 40% AT Execute/Cancel status. (See note 1.)
LAT	LAT	Alarm Latch Cancel	Specifies canceling all alarm latches. (See note 2.)
A-M	A-M	Auto/Manual	Specifies reversing the Auto/Manual status. (See note 3.)
PFDP	PFdP	Monitor/Setting Item	Specifies the monitor/setting item display. Select the monitor/setting item according to the Monitor/Setting Item 1 to 5 parameters (advanced function setting level).

- Note**
- (1) When AT cancel is specified, it means that AT is cancelled regardless of whether the AT currently being executed is 100% AT or 40% AT.
 - (2) Alarms 1 to 3, heater burnout, HS alarms, and heater overcurrent latches are cancelled.
 - (3) For details on auto/manual operations using the PF Key, refer to 4-13 *Performing Manual Control*.
 - (4) Pressing the PF Key for at least one second executes operation according to the set value. When the Monitor/Setting Item parameter is selected, however, the display is changed in order from Monitor/Setting Item 1 to 5 each time the key is pressed.
 - (5) This function is enabled when PF Key Protect is OFF.

Monitor/Setting Item

Monitor/Setting Item 1





Setting the PF Setting parameter to the Monitor/Setting Item makes it possible to display monitor/setting items using the function key. The following table shows the details of the settings. For setting (monitor) ranges, refer to the applicable parameter.

Set value	Setting	Remarks	
		Monitor/Setting	Symbol
0	Disabled		---
1	PV/SP/Multi-SP	Can be set. (SP)	---
2	PV/SP/MV (See note.)	Can be set. (SP)	---
3	PV/SP /Soak time remain	Can be set. (SP)	---
4	Proportional band (P)	Can be set.	P
5	Integral time (I)	Can be set.	I
6	Derivative time (D)	Can be set.	d
7	Alarm value 1	Can be set.	RL - 1
8	Alarm value upper limit 1	Can be set.	RL 1H
9	Alarm value lower limit 1	Can be set.	RL 1L
10	Alarm value 2	Can be set.	RL - 2
11	Alarm value upper limit 2	Can be set.	RL 2H
12	Alarm value lower limit 2	Can be set.	RL 2L
13	Alarm value 3	Can be set.	RL - 3
14	Alarm value upper limit 3	Can be set.	RL 3H
15	Alarm value lower limit 3	Can be set.	RL 3L

Note For details on MV settings for heating and cooling control, refer to *MV Display for Heating and Cooling Control* on page 84.

Setting Monitor/Setting Items

Pressing the PF Key in either the operation or adjustment level displays the applicable monitor/setting items. Press the PF Key to display in order Monitor/Setting Items 1 to 5. After Monitor/Setting Item 5 has been displayed, the display will switch to the top parameter in the operation level.

- Note**
- (1) Items set as disabled in the Monitor/Setting Items 1 to 5 parameters will not be displayed, and the display will skip to the next enabled setting.
 - (2) While a monitor/setting item is being displayed, the display will be switched to the top parameter in the operation level if the  Key or the  Key is pressed.

Operating Procedure

This procedure sets the PF Setting parameter to PFDP, and the Monitor/Setting Item 1 parameter to 7 (Alarm Value 1).

Operation Level



Initial Setting Level

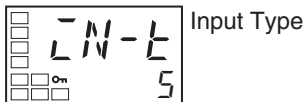

1. Press the  Key for at least three seconds to move from the operation level to the initial setting level.



2. Select the Move to Advanced Function Setting Level parameter by pressing the  Key.

Advanced Function Setting Level



Parameter Initialization

3. Press the Key to enter the password (-169). It is possible to move to the advanced function setting level by either pressing the Key or waiting two seconds without pressing any key.

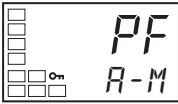

PF Setting

4. Press the Key to select the PF Setting parameter.



PF Setting

5. Press the Key to select PFDP (Monitor/Setting Item).

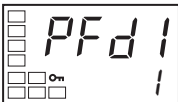

Monitor/Setting Item 1

6. Press the Key to select the Monitor/Setting Item 1 parameter.

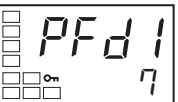

Monitor/Setting Item 1

7. Press the Key to select 7 (Alarm Value 1).

Initial Setting Level

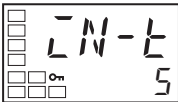

Input Type

8. Press the Key for at least one second to move from the advanced function setting level to the initial setting level.

Operation Level



9. Press the Key for at least one second to move from the initial setting level to the operation level.

Monitor/Setting Item Level

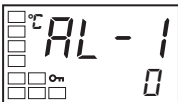

Monitor/Setting Item Display 1

10. Press the PF Key to display Alarm Value 1.

4-20 Counting Control Output ON/OFF Operations

4-20-1 Control Output ON/OFF Count Function

With Control Output 1 and 2 ON/OFF outputs (relay outputs or voltage outputs for driving SSR), the number of times that a control output turns ON and OFF can be counted. Based on the control output ON/OFF count alarm set value, an alarm can be output and an error can be displayed if the set count value is exceeded.

The default setting of the Control Output ON/OFF Alarm Setting parameter is 0. ON/OFF operations are not counted when this parameter is set to 0. To enable counting ON/OFF operations, change the setting to a value other than 0.

Control Output ON/OFF Counter Monitor Function

This function is not displayed when the Control Output 1 ON/OFF Alarm Setting and the Control Output 2 ON/OFF Alarm Setting parameter are set to 0, or when the control outputs are set for linear outputs.

Parameter name	Setting range	Unit	Default
Control Output 1 ON/OFF Count Monitor	0 to 9999	100 times	0
Control Output 2 ON/OFF Count Monitor	0 to 9999	100 times	0

Display When ON/OFF Count Alarm Occurs

When an ON/OFF count alarm occurs, the PV display in the No. 1 display shown below alternates with the *RRLM* display on the No. 2 display.

- PV
- PV/SP (Including the items displayed by setting the “PV/SP” Display Screen Selection parameter.)
- PV/Manual MV, PV/SP/Manual MV
- PV/SP displayed for the monitor/setting items

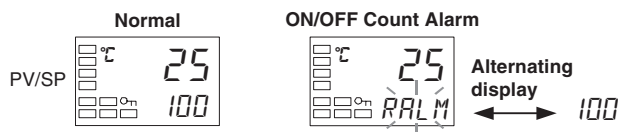

Control Output ON/OFF Count Alarm Function

If the ON/OFF counter exceeds the control output ON/OFF count alarm set value, an ON/OFF count alarm will occur. The alarm status can be assigned to a control output or an auxiliary output, or it can be displayed at the Controller. The ON/OFF count alarm set value function is disabled by setting the ON/OFF count alarm set value to 0.

Parameter name	Setting range	Unit	Default
Control Output 1 ON/OFF Alarm Setting	0 to 9999	100 times	0
Control Output 2 ON/OFF Alarm Setting	0 to 9999	100 times	0

ON/OFF Counter Reset Function

The ON/OFF counter can be reset for a specific control output.

Parameter name	Setting range	Unit	Default
ON/OFF Counter Reset	0: Disable the counter reset function. 1: Reset the control output 1 ON/OFF counter. 2: Reset the control output 2 ON/OFF counter.	---	0

Note After the counter has been reset, the control output ON/OFF count monitor value will be automatically returned to 0.

If an error occurs in the control output ON/OFF counter data, the ON/OFF count monitor value will be set to 9999 and an ON/OFF count alarm will occur. The alarm can be cleared by resetting the ON/OFF counter.

Operating Procedure

This procedure sets the Control Output 1 ON/OFF Alarm Setting parameter to 10 (1,000 times).

Initial Setting Level

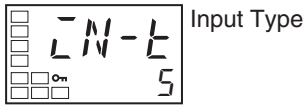

1. Press the Key for at least three seconds to move from the operation level to the initial setting level.

Initial Setting Level



2. Select the Move to Advanced Function Setting Level parameter by pressing the Key.

Advanced Function Setting Level

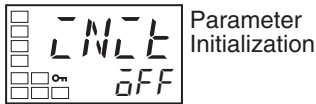

3. Use the Key to enter the password (“-169”). It is possible to move to the advanced function setting level by either pressing the Key or waiting two seconds without pressing any key.



4. Press the Key to select the Control Output 1 ON/OFF Count Alarm Set Value parameter.



5. Use the Key to set the parameter to 10.

Initial Setting Level

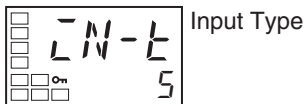

6. Press the Key for at least one second to move to the initial setting level.

Operation Level



7. Press the Key for at least one second to move to the operation level.

4-21 Displaying PV/SV Status

4-21-1 PV and SV Status Display Functions

PV Status Display Function

The PV in the PV/SP, PV, or PV/Manual MV Display and the control and alarm status specified for the PV status display function are alternately displayed in 0.5-s cycles.

Set value	Symbol	Function
OFF	OFF	No PV status display
Manual	MANU	MANU is alternately displayed during manual control.
Stop	STOP	STOP is alternately displayed while operation is stopped.
Alarm 1	ALM1	ALM1 is alternately displayed during Alarm 1 status.
Alarm 2	ALM2	ALM2 is alternately displayed during Alarm 2 status.

Set value	Symbol	Function
Alarm 3	<i>ALM3</i>	ALM3 is alternately displayed during Alarm 3 status.
Alarm 1 to 3 OR status	<i>ALM</i>	ALM is alternately displayed when Alarm 1, 2, or 3 is set to ON.
Heater Alarm (See note.)	<i>HA</i>	HA is alternately displayed when a heater burnout alarm, HS alarm, or heater over-current alarm is ON.

- The default is OFF.

Note “HA” can be selected for models that do not support heater burnout detection, but the function will be disabled.

Example: When STOP Is Selected for the PV Status Display Function



SV Status Display Function

The SP, Blank, or Manual MV in the PV/SP, PV, or PV/Manual MV Display and the control and alarm status specified for the SV status display function are alternately displayed in 0.5-s cycles.

Set value	Symbol	Function
OFF	<i>ōFF</i>	No SV status display
Manual	<i>MANU</i>	MANU is alternately displayed during manual control.
Stop	<i>5tōP</i>	STOP is alternately displayed while operation is stopped.
Alarm 1	<i>ALM1</i>	ALM1 is alternately displayed during Alarm 1 status.
Alarm 2	<i>ALM2</i>	ALM2 is alternately displayed during Alarm 2 status.
Alarm 3	<i>ALM3</i>	ALM3 is alternately displayed during Alarm 3 status.
Alarm 1 to 3 OR status	<i>ALM</i>	ALM is alternately displayed when Alarm 1, 2, or 3 is set to ON.
Heater Alarm (See note.)	<i>HA</i>	HA is alternately displayed when a heater burnout alarm, HS alarm, or heater over-current alarm is ON.

- The default is OFF.

Note “HA” can be selected for models that do not support heater burnout detection, but the function will be disabled.

Example: When ALM1 Is Selected for the SV Status Display Function

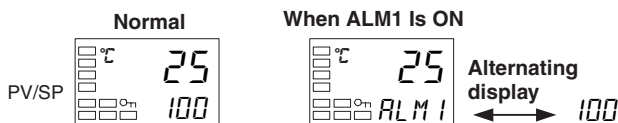

Operating Procedure

This procedure sets the PV Status Display Function parameter to ALM1.

Initial Setting Level

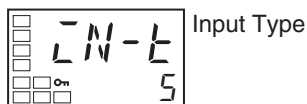

1. Press the Key for at least three seconds to move from the operation level to the initial setting level.

Initial Setting Level



2. Select the Move to Advanced Function Setting Level parameter by pressing the Key.

Advanced Function Setting Level

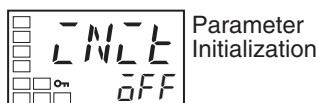

3. Use the Key to enter the password (-169). It is possible to move to the advanced function setting level by either pressing the Key or waiting two seconds without pressing any key.

PV Status Display Function

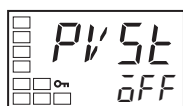

4. Press the Key to select the PV Status Display Function parameter.

PV Status Display Function

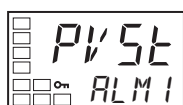

5. Press the Key to select ALM1.

Initial Setting Level

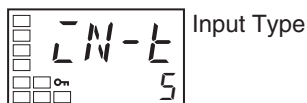

6. Press the Key for at least one second to move to the initial setting level.

Operation Level



7. Press the Key for at least one second to move to the operation level. If the Alarm 1 status is ON, PV and ALM1 will be alternately displayed.

4-22 Logic Operations

4-22-1 The Logic Operation Function (CX-Thermo)

- The logic operation function logically calculates as 1 or 0 the Controller status (alarms, SP ramp, RUN/STOP, auto/manual, etc.) and the external event input status, and outputs the results to work bits. The work bit status can be output to auxiliary or control outputs, and operating status can be switched according to the work bit status.
- Work bit logic operation can be set from 1 to 8. Set them to *No operation (Always OFF)* (the default) when the work bits are not to be used. When logic operations are being used, a dot will be displayed on the No. 2 display of the adjustment level display

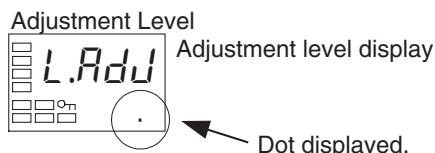

4-22-2 Using Logic Operations

Logic operations are set using the CX-Thermo.

Starting Logic Operations

There are two ways to start logic operations.

- Select *Logic Operation Editor* from the CX-Thermo tree, and click the **Start** Button.

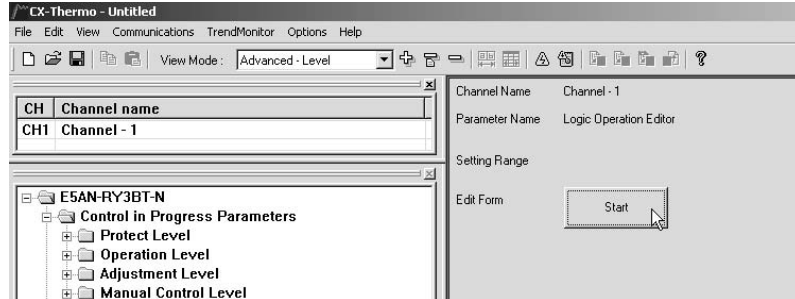

- Select *Logic Operation Editor* from the CX-Thermo Options Menu.

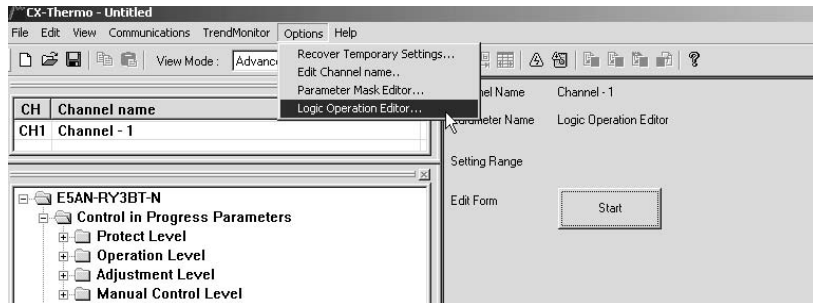

Making the Settings

The following display will appear on the Logic Operation Editor Setting Window. Set each of the parameters.

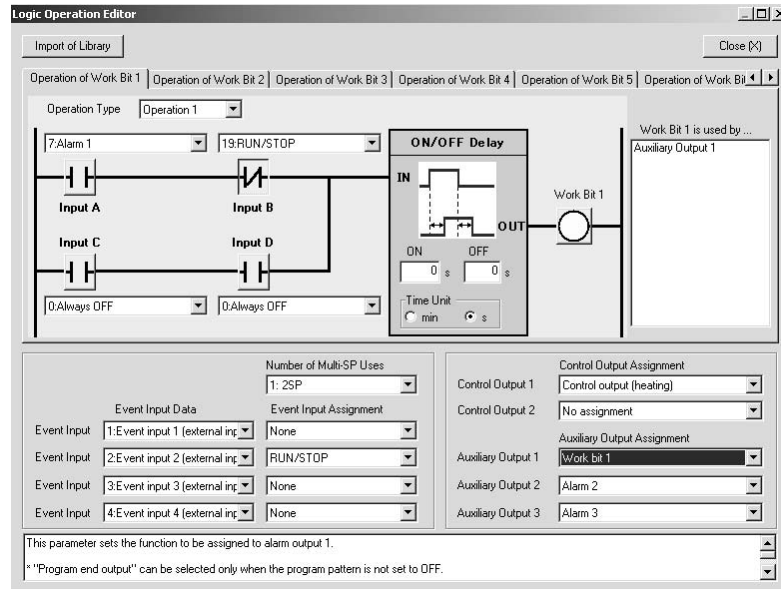

1,2,3...

1. Displaying the Library Import Dialog Box

Logic operation samples for specific cases are set in the library in advance. Examples of settings for specific cases are loaded by selecting them from the library list and clicking the **OK** Button.

Example: Selecting Library 1

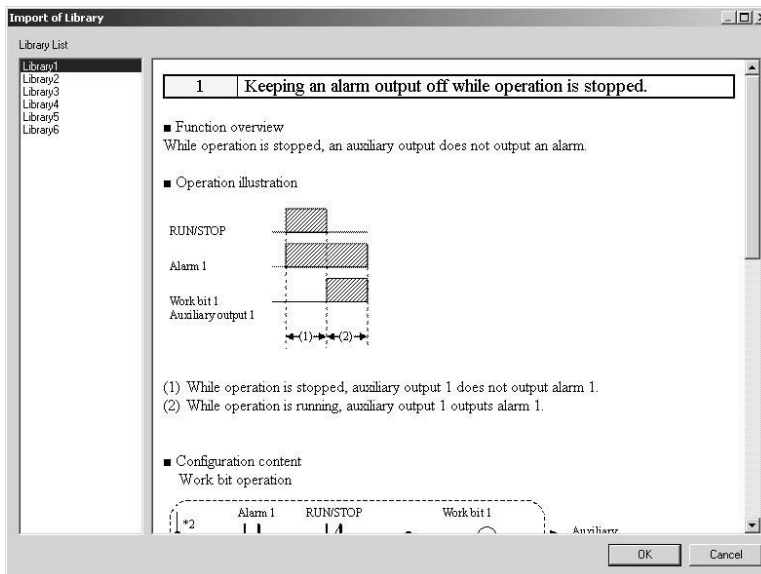

2. Switching Work Bit Operations

Select the work bit logic operations from the Operation of Work Bit 1 to Operation of Work Bit 8 Tab Pages.

3. Selecting the Operation Type

From one to four operations are supported. If work bits are not to be used, set them to *No operation (Always OFF)* (the default).

- No operation (Always OFF)

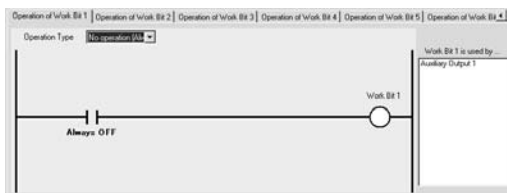

- Operation 1

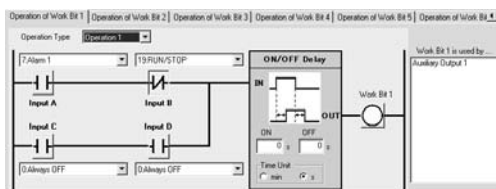

(A and B) or (C and D)
When conditions A and B or conditions C and D are satisfied

- Operation 2

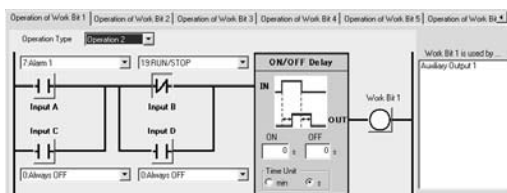

(A or C) and (B or D)
When condition A or C and condition B or D are satisfied

• Operation 3

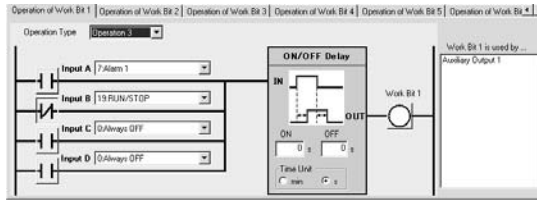

A or B or C or D
When condition A,
B, C or D is satisfied

• Operation 4

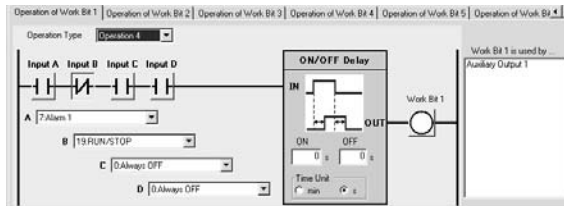

A and B and C
and D
When conditions
A, B, C and D are
all satisfied



4. Selecting Input Assignments

Select the input assignment for the work bit logic operation from the following settings.



Parameter name	Setting range
Work Bit 1 Input Assignment A	0: Always OFF 1: Always ON 2: ON for one cycle when power is turned ON 3: Event input 1 (external input) (See note 1.) 4: Event input 2 (external input) (See note 1.) 5: Event input 3 (external input) (See note 1.) 6: Event input 4 (external input) (See note 1.) 7: Alarm 1 8: Alarm 2 9: Alarm 3 10: Control output ON/OFF count alarm (See note 2.) 11: Control output (heating) 12: Control output (cooling) 13: Input error 14: Disabled 15: HB (heater burnout) alarm 16: HS alarm 17: OC (heater overcurrent) alarm 18: Auto/Manual 19: RUN/STOP 20: Disabled 21: Program start 22: AT Execute/Cancel 23: SP ramp operating 24: Multi-SP (bit 0) 25: Multi-SP (bit 1) 26: Disabled 27: Program end output 28: Work bit 1 29: Work bit 2 30: Work bit 3 31: Work bit 4 32: Work bit 5 33: Work bit 6 34: Work bit 7 35: Work bit 8
Work Bit 1 Input Assignment B	Same as for work bit 1 input assignment A
Work Bit 1 Input Assignment C	Same as for work bit 1 input assignment A
Work Bit 1 Input Assignment D	Same as for work bit 1 input assignment A
to	to
Work Bit 8 Input Assignment D	Same as for work bit 1 input assignment A

Note (1) The event inputs that can be used depend on the Controller model.

- (2) Turns ON when either the control output 1 or 2 ON/OFF count alarm is ON.
- 5. Switching between Normally Open and Normally Closed for Inputs A to D
Click the condition to switch between normally open and normally closed inputs A to D.

Normally open	Normally closed
	

- 6. Switching between Normally Open and Normally Closed for Work Bits
Click the condition to switch between normally open and normally closed work bits.

Normally open	Normally closed
	

- 7. Setting ON Delay Times
When an input with ON delay turns ON, the output will turn ON after the set delay time has elapsed. The setting range is 0 to 9,999. The default is 0 (disabled).
- 8. Setting OFF Delay Times
When an input with OFF delay turns OFF, the output will turn OFF after the set delay time has elapsed. The setting range is 0 to 9,999. The default is 0 (disabled).
- 9. Switching ON/OFF Delay Time Unit
Select either seconds or minutes for the ON/OFF delay time unit. The default is seconds.
- 10. Selecting the Number of Multi-SP Uses
Select the number of Multi-SP uses from 0 to 2.
- 11. Changing Event Input Data
Select the event input conditions from the following setting ranges.

Parameter name	Setting range
Event Input Data 1	0: Not assigned. 1: Event input 1 (external input) 2: Event input 2 (external input) 3: Event input 3 (external input) 4: Event input 4 (external input) 5: Work bit 1 6: Work bit 2 7: Work bit 3 8: Work bit 4 9: Work bit 5 10: Work bit 6 11: Work bit 7 12: Work bit 8
Event Input Data 2	Same as for event input data 1
Event Input Data 3	Same as for event input data 1
Event Input Data 4	Same as for event input data 1

Note The event input data can be changed from the default setting even if there is no event input terminal (external input). By changing the default setting, the event input assignment parameters will be displayed at the Controller display and can be set from the Controller.

12. Changing the Event Input Assignment Function

Select the setting for the event input assignment.
When a work bit is selected as event input data, Communications Write Enable/Disable cannot be assigned to an event input.

13. Changing Control Output and Auxiliary Output Settings

Control output and auxiliary output assignments can be changed. The items that can be changed depend on the Controller model. For details, refer to 3-5-3 *Assigned Output Functions*.

Assigning a work bit to either a control output or to an auxiliary output is also considered to be the same as assigning an alarm. For example, if work bit 1 is set for the Auxiliary Output 1 Assignment parameter, then alarms 1 to 3 have been assigned.

14. Displaying Parameter Guides

A description of the parameters can be displayed.

15. Displaying the Work Bit Use Destinations

Display a list of destinations where the work bits are used.

Operating Procedure

This procedure uses event input 2 to change to RUN or STOP.

Event input 2 ON: RUN

Event input 2 OFF: STOP

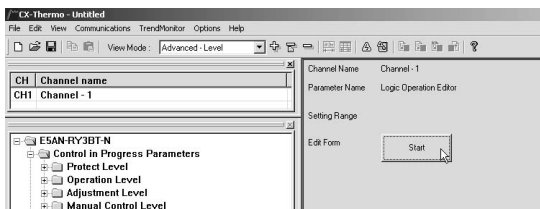
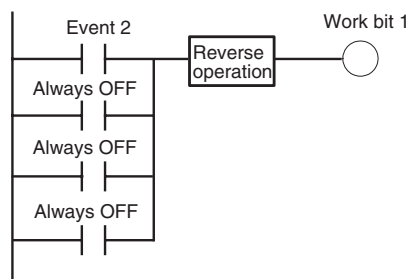

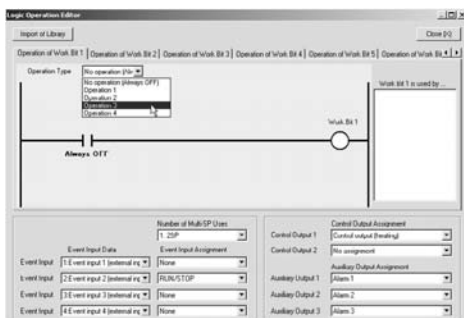

1. Select *Logic Operation Editor* from the CX-Thermo tree, and click the **Start** Button.

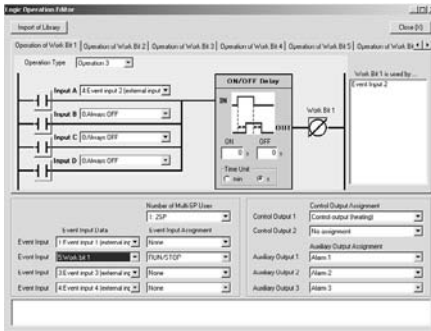

2. The Logic Operation Editor will be displayed. Confirm that the screen for work bit 1 is displayed, and select *Operation 3* from the *Operation Type* Field.



3. Set the operation by selecting one of the following:
 Work bit 1 input assignment A = 4: Event input 2 (external input)
 Work bit 1 input assignment B = 0: Always OFF
 Work bit 1 input assignment C = 0: Always OFF
 Work bit 1 input assignment D = 0: Always OFF
4. Invert work bit 1. Click  (Normally open) to change it to  (Normally closed).
5. Assign RUN/STOP to event input 2. Set “5: Work bit 1” for the event input data for event input 2, and set “RUN/STOP” for the assignment function.
6. Closing the Logic Operation Editor Dialog Box
 Click the **Close** Button.

This completes the procedure for setting parameters using the CX-Thermo. Transfer the settings to the Controller to set the Controller. Refer to CX-Thermo help for the procedure to transfer the settings.

Operating Procedure

This procedure outputs alarm 1 status to auxiliary output 1 during operation (RUN). A library object is used to make the setting.

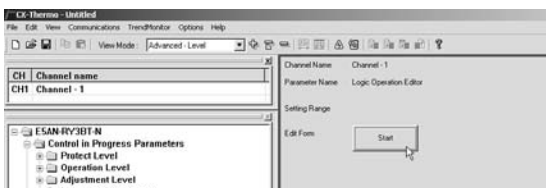
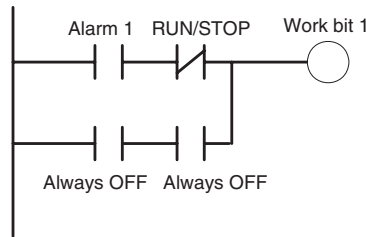

1. Select **Logic Operation Editor** from the CX-Thermo tree, and click the **Start** Button.
2. Click the **Import of Library** Button.

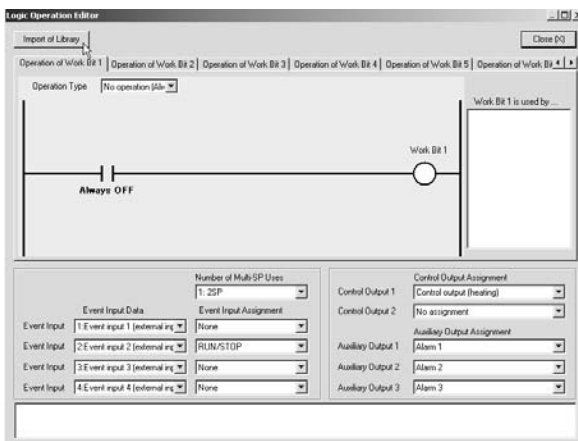

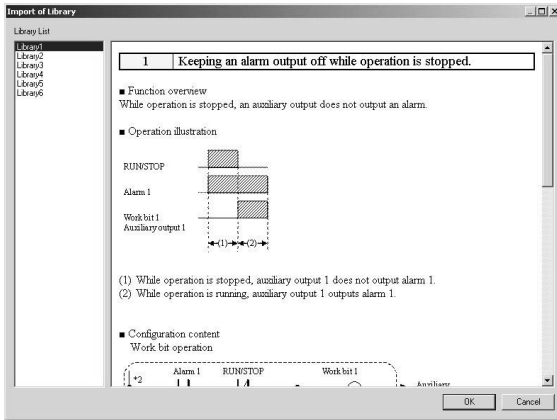

3. Select *Library 1* from the library list, and then click the **OK** Button.

Confirm the following settings, and then click the **OK** Button.

Work bit 1 operation type: Operation 1

Work bit 1 input assignment A = 7: Alarm 1

Work bit 1 input assignment B = 19: Invert for RUN/STOP

Work bit 1 input assignment C = 0: Always OFF

Work bit 1 input assignment D = 0: Always OFF

Auxiliary output 1 = Work bit 1

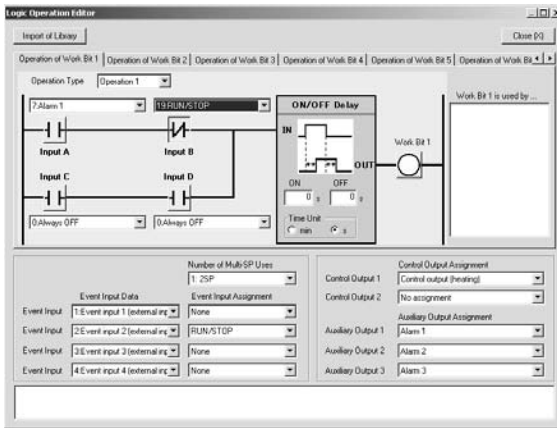

4. Closing the Logic Operation Editor Dialog Box
Click the **Close** Button.

This completes the procedure for setting parameters using the CX-Thermo. Transfer the settings to the Controller to set the Controller. Refer to CX-Thermo help for the procedure to transfer the settings.

SECTION 5

Parameters

This section describes the individual parameters used to setup, control, and monitor operation.

5-1	Conventions Used in this Section	158
5-1-1	Meanings of Icons Used in this Section	158
5-1-2	About Related Parameter Displays	158
5-1-3	The Order of Parameters in This Section	158
5-1-4	Alarms.	158
5-2	Protect Level	159
5-3	Operation Level.	163
5-4	Adjustment Level	177
5-5	Monitor/Setting Item Level.	196
5-6	Manual Control Level.	197
5-7	Initial Setting Level.	199
5-8	Advanced Function Setting Level.	218
5-9	Communications Setting Level.	255

5-1 Conventions Used in this Section

5-1-1 Meanings of Icons Used in this Section



Function

Describes the functions of the parameter.



Setting

Describes the setting range and default of the parameter.



Monitor

Used to indicate parameters used only for monitoring.



Operation

Describes the parameter settings, such as those for Operation Commands, and procedures.



Used to indicate information on descriptions in which the parameter is used or the names of related parameters.

5-1-2 About Related Parameter Displays

Parameters are displayed only when the conditions for use given on the right of the parameter heading are satisfied. Protected parameters are not displayed regardless of the conditions for use, but the settings of these parameters are still valid.



5-1-3 The Order of Parameters in This Section

Parameters are described level by level.

The first page of each level describes the parameters in the level and the procedure to switch between parameters.

5-1-4 Alarms

It will be specified in this section when alarms are set for the Control Output 1 or 2 Assignment parameters, or for the Auxiliary Output 1 or 3 Assignment parameters. For example, when alarm 1 is set for the Control Output 1 Assignment parameter, it will be specified that alarm 1 is assigned.

Assigning a work bit to either control output 1 or 2 or to auxiliary output 1 to 3 is also considered to be the same as assigning an alarm. For example, if work bit 1 is set for the Auxiliary Output 1 Assignment parameter, then alarms 1 to 3 have been assigned.

5-2 Protect Level

Four levels of protection are provided on the E5□N, operation/adjustment protect, initial setting/communications protect, setting change protect, and PF key protect (E5AN/EN only). These protect levels prevent unwanted operation of the keys on the front panel in varying degrees.

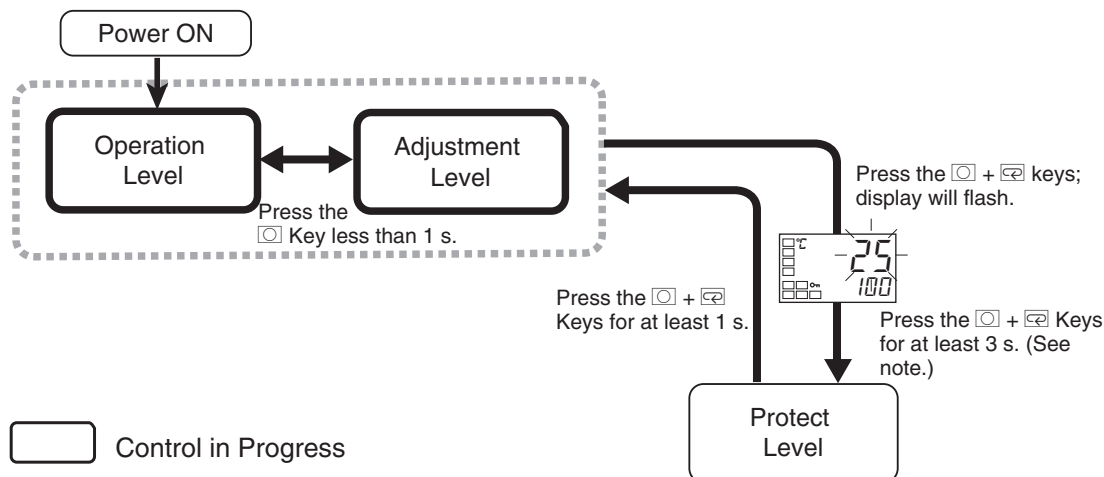

To move from the operation level to the protect level, press [] and [] Keys for three seconds (see note) or more.

Note The time taken to move to the protect level can be adjusted by changing the Move to Protect Level Time parameter setting.

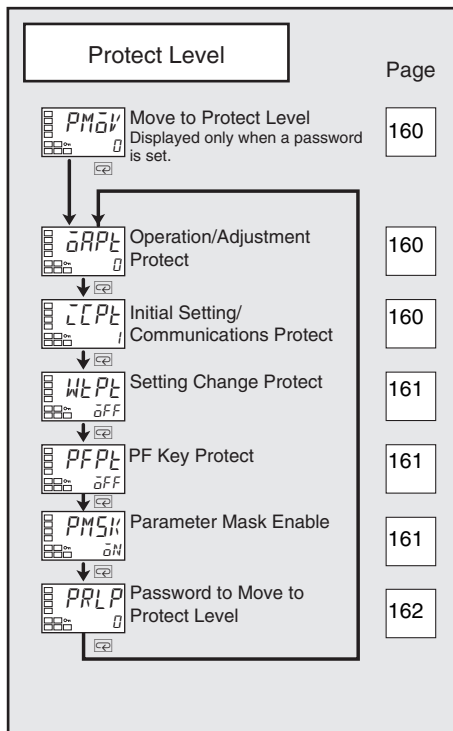

Parameters that are protected will not be displayed and their settings cannot be changed.

PMoV

Move to Protect Level

The Password to Move to Protect Level password must not be set to 0.



Function

The password to move to the protect level is entered for this parameter.

- The password to move to the protect level (i.e., the password set for the Password to Move to Protect Level parameter) is entered for this parameter.
- The Operation/Adjustment Protect parameter will be displayed if the correct password is entered.



■ **Related Parameters**

Password to move to protect level (protect level): Page 162

oAPt

Operation/Adjustment Protect

oCPt

Initial Setting/Communications Protect

These parameters specify the range of parameters to be protected. Shaded settings are the defaults.



Function

■ **Operation/Adjustment Protect**

The following table shows the relationship between set values and the range of protection.



Setting

Level		Set value			
		0	1	2	3
Operation Level	PV	Can be displayed	Can be displayed	Can be displayed	Can be displayed
	PV/SP	Can be displayed and changed	Can be displayed and changed	Can be displayed and changed	Can be displayed
	Others	Can be displayed and changed	Can be displayed and changed	Cannot be displayed and moving to other levels is not possible	Cannot be displayed and moving to other levels is not possible
Adjustment Level		Can be displayed and changed	Cannot be displayed and moving to other levels is not possible	Cannot be displayed and moving to other levels is not possible	Cannot be displayed and moving to other levels is not possible

- Parameters are not protected when the set value is set to 0.

■ **Initial Setting/Communications Protect**

This protect level restricts movement to the initial setting level, communications setting level, and advanced function setting level.

Set value	Initial setting level	Communications setting level	Advanced function setting level
0	Possible to reach	Possible to reach	Possible to reach
1	Possible to reach	Possible to reach	Not possible to reach
2	Not possible to reach	Not possible to reach	Not possible to reach

WLPt

Setting Change Protect

The Event Input Assignment 1 and 2 parameters must not be set to “setting change enable/disable.”

This parameter specifies the range of data to be protected. The shaded cell indicates the default.



Function



Setting

■ Change Setting Protect

Changes to settings using key operations are restricted.

When enabling and disabling of setting changes by event inputs assignment 1 and 2 is selected, this parameter is not displayed.

Setting range	Default
$\bar{a}N$: Enabled, $\bar{a}FF$: Disabled	$\bar{a}N$

Set value	Description
OFF	Settings can be changed using key operations.
ON	Settings cannot be changed using key operations. (The protect level settings, however, can be changed.)

- The all protect indication (**On**) will light when setting is ON.

PFPL

PF Key Protect

The Controller must have a PF Key (E5AN/EN).



Function



Setting

■ PF Key Protect

This parameter enables and disables PF Key operation (E5AN/EN only).

Set value	Description
OFF	PF Key enabled
ON	PF Key disabled (Operation as a function key is prohibited.)

- The shaded cell indicates the default.

PMSK

Parameter Mask Enable

This parameter is displayed only when a parameter mask has been set from the Setup Tool.



Function



Setting

- This parameter turns the parameter mask function ON and OFF.

Setting range	Default
$\bar{a}N$: Enabled, $\bar{a}FF$: Disabled	$\bar{a}N$

Note A parameter mask can be used to hide the displays of parameters that are not needed. The parameter mask function is provided by the Setup Tool.
Setup Tool: CX-Thermo (EST2-2C-MV4)





PRLP

Password to Move to Protect Level



Function

This parameter is used to set the password to move to the protect level.

- To prevent setting the password incorrectly, the  and  Keys or  and  Keys must be pressed simultaneously to set the password.



Setting

Setting range	Default
-1999 to 9999	0

- Set this parameter to 0 when no password is to be set.



■ **Related Parameters**

Move to protect level (protect level): Page 160

Note Protection cannot be cleared or changed without the password. Be careful not to forget it. If you forget the password, contact your OMRON sales representative.

5-3 Operation Level

Display this level to perform control operations on the E5□N. You can set alarm values, monitor the manipulated variable, and perform other operations in this level.

In the advanced function setting level, you can set a parameter to hide or show the set points.

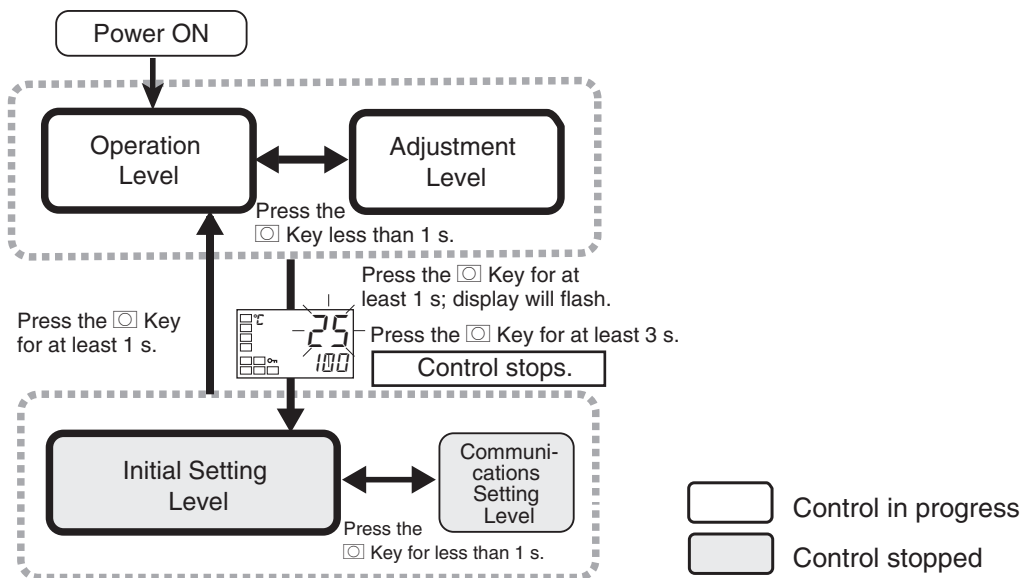

This level is displayed immediately after the power is turned ON.

To move to other levels, press the **□** Key or the **□** and **↵** Keys.

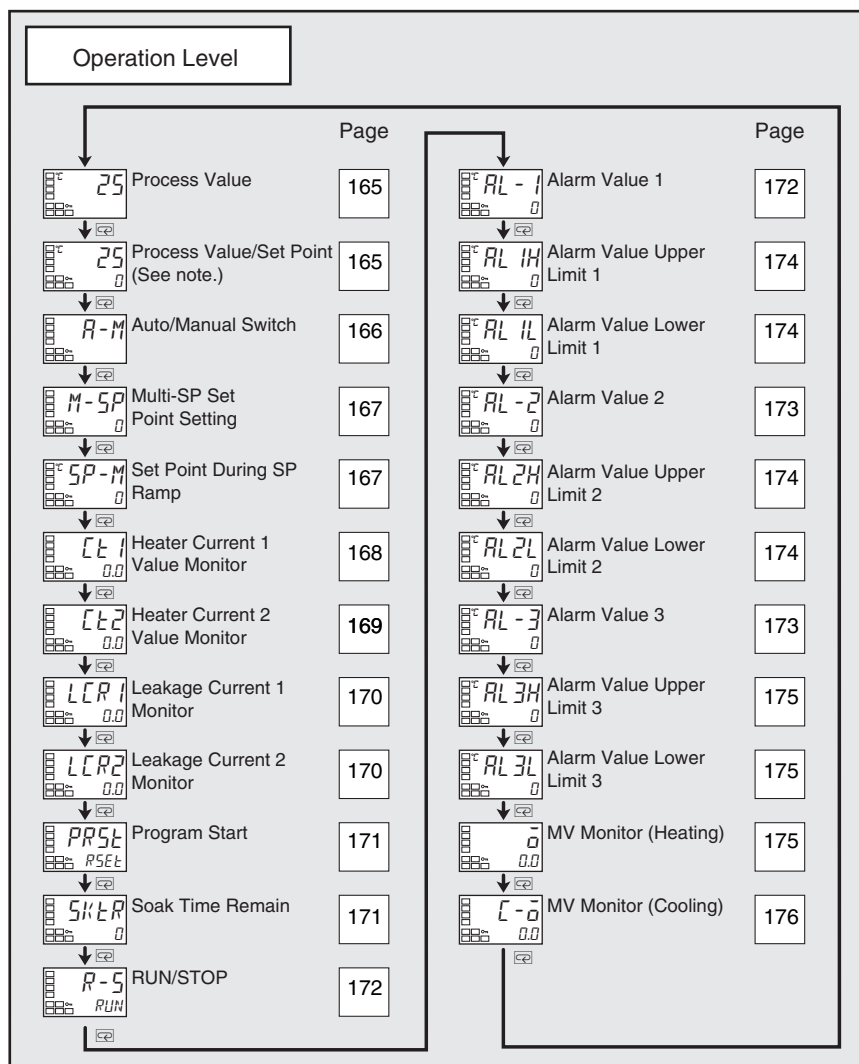

Note For details on the displays of Controllers with a No. 3 display (E5AN/EN), refer to *Process Value/Set Point* on page 165.

Process Value

The Additional PV Display parameter must be set to ON.



Function

The process value is displayed on the No. 1 display, and nothing is displayed on the No. 2 and No. 3 (E5AN/EN only) displays.



Monitor

	Monitor range	Unit
Process value	Temperature: According to indication range for each sensor. Analog: Scaling lower limit -5% FS to Scaling upper limit +5% FS (Refer to page 303.)	EU

During temperature input, the decimal point position depends on the currently selected sensor, and during analog input it depends on the Decimal Point parameter setting.

The default setting is for a K thermocouple (5).

An *S.ERR* error will be displayed if the input type setting is incorrect. To clear the *S.ERR* error, correct the input type or wiring, and then cycle the power.



■ **Related Parameters**

Input type: Page 200, Set point upper limit, Set point lower limit: Page 203 (initial setting level)

Process Value/Set Point (Display 1)

Process Value/Set Point (Display 2)

(E5AN/EN only)



Function

The process value is displayed on the No. 1 display, and the set point is displayed on the No. 2 display.



Monitor

	Monitor range	Unit
Process value	Temperature: According to indication range for each sensor. Analog: Scaling lower limit -5% FS to Scaling upper limit +5% FS (Refer to page 303.)	EU

	Setting range	Unit
Set point	SP lower limit to SP upper limit	EU

During temperature input, the decimal point position depends on the currently selected sensor, and during analog input it depends on the Decimal Point parameter setting.

No. 3 Display (E5AN/EN)

The following table shows the contents of the No. 3 display, according to the setting of the PV/SP Display Screen Selection parameter.

Set value	Display contents
0	Only the PV and SP are displayed. (The No. 3 display is not shown.)
1	PV/SP/Multi-SP and PV/SP/MV are displayed in order.
2	PV/SP/MV and PV/SP/Multi-SP are displayed in order.
3	Only PV/SP/Multi-SP are displayed.
4	PV/SP/MV are displayed
5	PV/SP/Multi-SP and PV/SP/Soak time remain are displayed in order.
6	PV/SP/MV and PV/SP/Soak time remain are displayed in order.
7	Only PV/SP/Soak time remain are displayed.

A 2-level display is set when shipped from the factory.

A 3-level display is activated if parameters are initialized.

When 1, 2, 5, or 6 is selected, press the  Key to display PV/SP (Display 2).

Example: When the PV/SP Display Screen Selection Parameter Is Set to 2

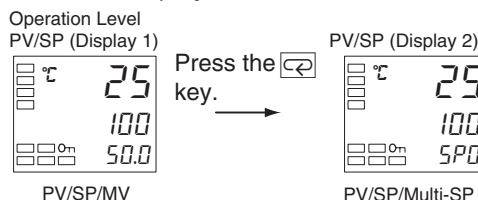

■ Related Parameters

Input type: Page 200, Set point upper limit, Set point lower limit: Page 203 (initial setting level)

PV/SP display screen selection (advanced function setting level): Page 249

R-M

Auto/Manual Switch

The Event Input Assignment 1 and 2 parameters must not be set to Auto/Manual and the Auto/Manual Select Addition parameter must be set to ON.
The control must be set to 2-PID control.



- This parameter switches the Controller between automatic and manual modes.
- If the  Key is pressed for at least 3 seconds when the Auto/Manual Switch parameter is displayed, the manual mode will be entered and the manual control level will be displayed.
- This parameter will not be displayed if an event input is set to “MANU” (auto/manual).



■ Related Parameters

PID ON/OFF (initial setting level): Page 204

Auto/manual select addition (advanced function setting level): Page 234

M-SP

**Multi-SP Set Point Setting
(Set Points 0 to 3)**

The Multi-SP Uses parameter must be set to ON.



Function

To use the multi-SP function, preset the four set points (SP 0 to 3) in the adjustment level, and then switch the set point either by operating the keys or by using external input signals (event inputs).

This parameter is used to select set points 0 to 3.

SP-M

Set Point During SP Ramp

The SP Ramp Set Value parameter must not be set to OFF.
The ST parameter must be set to OFF.



Function

This parameter monitors the set point during SP ramp operation.
A ramp is used to restrict the change width of the set point as a rate of change.

This parameter is displayed when a set value is input for the SP Ramp Set Value parameter (adjustment level).

When not in ramp operation, the set point will be the same as the one displayed for the Process Value/Set Point parameter.



Monitor

Monitor range	Unit
SP: SP lower limit to SP upper limit	EU



■ **Related Parameters**

Process value/set point (operation level): Page 165

SP ramp set value (adjustment level): Page 193

Set point upper limit, Set point lower limit (initial setting level): Page 203

☐ 1

Heater Current 1 Value Monitor

Heater burnout, HS alarm, and heater overcurrent detection must be supported.
Alarm 1 must be assigned.
The Heater Burnout Detection or Heater Overcurrent Use parameter must be set to ON.



Function

This parameter measures the heater current from the CT input used for detecting heater burnout.

This parameter measures and displays the heater current value.

- Heater burnouts and heater overcurrent are not detected if the control output (heating) ON time is 100 ms or less.



Monitor

Monitor range	Unit
0.0 to 55.0	A

- FFFF is displayed when 55.0 A is exceeded.
- If a heater burnout detection 1 or heater overcurrent detection 1 alarm is output, the HA indicator will light and the No. 1 display for the heater current 1 value monitor will flash.



■ **Related Parameters**

Heater burnout detection 1, Heater burnout detection 2 (adjustment level): Pages 181, and 183

HB ON/OFF (advanced function setting level): Page 222

Heater overcurrent detection 1, Heater overcurrent detection 2 (adjustment level): Pages 181, and 183

Heater overcurrent use (advanced function setting level): Page 246

Error Displays ☐ 1: Page 283

☐☐☐

Heater Current 2 Value Monitor

Heater burnout, HS alarm, and heater overcurrent detection must be supported (two CTs). Alarm 1 must be assigned. The Heater Burnout Detection or Heater Overcurrent Use parameter must be set to ON.



Function

This parameter measures the heater current from the CT input used for detecting heater burnout.

This parameter measures and displays the heater current value.

- Heater burnouts and heater overcurrent are not detected if the control output (heating) ON time is 100 ms or less.



Monitor

Monitor range	Unit
0.0 to 55.0	A

- FFFF is displayed when 55.0 A is exceeded.
- If a heater burnout detection 2 or heater overcurrent detection 2 alarm is output, the HA indicator will light and the No. 1 display for the heater current 2 value monitor will flash.



■ **Related Parameters**

Heater burnout detection 1, Heater burnout detection 2 (adjustment level): Pages 181, and 183

HB ON/OFF (advanced function setting level): Page 222

Heater overcurrent detection 1, Heater overcurrent detection 2 (adjustment level): Pages 181, and 183

Heater overcurrent use (advanced function setting level): Page 246

Error Displays ☐☐☐: Page 283

LCR1

Leakage Current 1 Monitor

Heater burnout, HS alarms, and heater overcurrent detection must be supported.
Alarm 1 must be assigned.
The HS Alarm Use parameter must be set to ON.



Function

This parameter measures the heater current from the CT input used for detecting SSR short-circuits.

The heater current is measured and the leakage current 1 monitor is displayed.

- HS alarms are not detected if the control output (heating) OFF time is 100 ms or less.

Monitor range	Unit
0.0 to 55.0	A

- FFFF is displayed when 55.0 A is exceeded.
- If an HS alarm 1 alarm is output, the HA indicator will light and the No. 1 display for the leakage current 1 monitor will flash.



Monitor

■ **Related Parameters**

HS alarm 1, HS alarm 2 (adjustment level): Page 184

Failure detection (advanced function setting level): Page 235

Error Displays LCR1: Page 283



See

LCR2

Leakage Current 2 Monitor

Heater burnout, HS alarms, and heater overcurrent detection must be supported (two CTs).
Alarm 1 must be assigned.
The HS Alarm Use parameter must be set to ON.



Function

This parameter measures the heater current from the CT input used for detecting SSR short-circuits.

This parameter measures and displays the heater current value.

- HS alarms are not detected if the control output (heating) OFF time is 100 ms or less.

Monitor range	Unit
0.0 to 55.0	A

- FFFF is displayed when 55.0 A is exceeded.
- If an HS alarm 2 alarm is output, the HA indicator will light and the No. 1 display for the leakage current 2 monitor will flash.



Monitor

■ **Related Parameters**

HS alarm 1, HS alarm 2 (adjustment level): Page 184

HS alarm use (advanced function setting level): Page 235

Error Displays LCR2: Page 283



See

PR5L

Program Start

The Program Pattern parameter must not be set to OFF.



This parameter starts and stops the simple program function.

- The RUN/STOP status will automatically switch to RUN when this parameter is set to STRT.
- The simple program will stop when this parameter is set to RSET.
- This parameter will function as a monitor display for the start/stop status of the simple program if an event input is selected to start the simple program.



Setting range		Default
RSET	Stops the simpler program.	R5EŁ
STRT	Starts the simpler program.	



■ **Related Parameters**

- Soak time remain: Page 171, RUN/STOP: Page 172 (operation level)
- Soak time, Wait band (adjustment level): Page 191
- Program pattern (initial setting level): Page 205
- Soak time unit (advanced function setting level): Page 243

SKŁR

Soak Time Remain

The Program Pattern parameter must not be set to OFF.



- This parameter measures and displays the remaining time of the soak time for the simple program function.



Monitor range	Unit
0 to 9999	min or h



■ **Related Parameters**

- Program start (operation level): Page 171
- Soak time, Wait band (adjustment level): Page 191
- Program pattern (initial setting level): Page 205
- Soak time unit (advanced function setting level): Page 243

R-5

RUN/STOP

The Event Input Assignment 1 and 2 parameters must not be set to "RUN/STOP"



Operation

This parameter starts and stops the control operation. When *RUN* (RUN) is selected, control is started. When *STOP* (STOP) is selected, control is stopped. The STOP indicator will light when control. The default is *RUN*.



This parameter will not be displayed if an event input is set to "RUN/STOP"

RL - 1

Alarm Value 1

Alarm 1 must be assigned. The alarm 1 type must not be 0, 1, 4, 5, or 12.



Function

This parameter is set to one of the input values "X" in the alarm type list.

- This parameter sets the alarm value for alarm 1.
- During temperature input, the decimal point position depends on the currently selected sensor, and during analog input it depends on the Decimal Point parameter setting.



Setting

Setting range	Unit	Default
-1999 to 9999	EU	0



■ **Related Parameters**

Input type: Page 200, Scaling upper limit, Scaling lower limit, Decimal point (initial setting level): Page 202 (initial setting level)
 Alarm 1 type (initial setting level): Page 207
 Standby sequence reset: Page 221, Auxiliary output * open in alarm: Page 222, Alarm 1 hysteresis: Page 209, Alarm 1 latch: Page 227 (advanced function setting level)

RL - 2

Alarm Value 2

Alarm 2 must be assigned.
The alarm 2 type must not be 0, 1, 4, 5, or 12.



This parameter is set to one of the input values “X” in the alarm type list.

- This parameter sets the alarm value for alarm 2.
- During temperature input, the decimal point position depends on the currently selected sensor, and during analog input it depends on the Decimal Point parameter setting.



Setting range	Unit	Default
-1999 to 9999	EU	0



■ **Related Parameters**

Input type: Page 200, Scaling upper limit, Scaling lower limit, Decimal point (initial setting level): Page 202 (initial setting level)

Alarm 2 type (initial setting level): Page 209

Standby sequence reset: Page 221, Auxiliary output * open in alarm: Page 222, Alarm 2 hysteresis: Page 209, Alarm 2 latch: Page 227 (advanced function setting level)

RL - 3

Alarm Value 3

Alarm 3 must be assigned.
The alarm 3 type must not be 0, 1, 4, 5, or 12.



This parameter is set to one of the input values “X” in the alarm type list.

- This parameter sets the alarm value for alarm 3.
- During temperature input, the decimal point position depends on the currently selected sensor, and during analog input it depends on the Decimal Point parameter setting.



Setting range	Unit	Default
-1999 to 9999	EU	0



■ **Related Parameters**

Input type: Page 200, Scaling upper limit, Scaling lower limit, Decimal point (initial setting level): Page 202 (initial setting level)

Alarm 3 type (initial setting level): Page 210

Standby sequence reset: Page 221, Auxiliary output * open in alarm: Page 222, Alarm 3 hysteresis: Page 209, Alarm 3 latch: Page 227 (advanced function setting level)

AL 1H
AL 1L

Alarm Value Upper Limit 1
Alarm Value Lower Limit 1

Alarm 1 must be assigned.
The alarm 1 type must not be 1, 4, or 5.



These parameters independently set the alarm value upper and lower limits when the mode for setting the upper and lower limits is selected for the Alarm 1 Type parameter (initial setting level).

- This parameter sets the upper and lower limit values of alarm 1.
- During temperature input, the decimal point position depends on the currently selected sensor, and during analog input it depends on the Decimal Point parameter setting.



Setting range	Unit	Default
-1999 to 9999	EU	0



■ **Related Parameters**

Input type: Page 200, Scaling upper limit, Scaling lower limit, Decimal point: Page 202, Alarm 1 type: Page 207 (initial setting level), Standby sequence reset: Page 221, Auxiliary output * open in alarm: Page 222, Alarm 1 hysteresis: Page 209, Alarm 1 latch: Page 227 (advanced function setting level)

AL 2H
AL 2L

Alarm Value Upper Limit 2
Alarm Value Lower Limit 2

Alarm 2 must be assigned.
The alarm 2 type must not be 1, 4, or 5.



These parameters independently set the alarm value upper and lower limits when the mode for setting the upper and lower limits is selected for the Alarm 2 Type parameter (initial setting level).

- This parameter sets the upper and lower limit values of alarm 2.
- During temperature input, the decimal point position depends on the currently selected sensor, and during analog input it depends on the Decimal Point parameter setting.



Setting range	Unit	Default
-1999 to 9999	EU	0



■ **Related Parameters**

Input type: Page 200, Scaling upper limit, Scaling lower limit, Decimal point: Page 202, Alarm 2 type: Page 209 (initial setting level), Standby sequence reset: Page 221, Auxiliary output * open in alarm: Page 222, Alarm 2 hysteresis: Page 209, Alarm 2 latch: Page 227 (advanced function setting level)

AL 3H
AL 3L

Alarm Value Upper Limit 3
Alarm Value Lower Limit 3

Alarm 3 must be assigned.
The alarm 3 type must not be 1, 4, or 5.



These parameters independently set the alarm value upper and lower limits when the mode for setting the upper and lower limits is selected for the Alarm 3 Type parameter (initial setting level).

- This parameter sets the upper and lower limit values of alarm 3.
- During temperature input, the decimal point position depends on the currently selected sensor, and during analog input it depends on the Decimal Point parameter setting.



Setting range	Unit	Default
-1999 to 9999	EU	0



■ **Related Parameters**

Input type: Page 200, Scaling upper limit, Scaling lower limit, Decimal point: Page 202, Alarm 3 type: Page 210 (initial setting level), Standby sequence reset: Page 221, Auxiliary output * open in alarm: Page 222, Alarm 3 hysteresis: Page 209, Alarm 3 latch: Page 227 (advanced function setting level)

ō

MV Monitor (Heating)

The MV Display parameter must be set to ON.



This parameter is used to check the manipulated variable for the heating control output during operation.

- This parameter cannot be set.
- During standard control, the manipulated variable is monitored. During heating/cooling control, the manipulated variables on the control output (heating) is monitored.
- The default is OFF and the manipulated variable is not displayed.



Control	Monitor range	Unit
Standard	-5.0 to 105.0	%
Heating/cooling	0.0 to 105.0	%



■ **Related Parameters**

MV display (advanced function setting level): Page 227

[- 0]

MV Monitor (Cooling)

The control system must be set to heating/cooling control.
The MV Display parameter must be set to ON.



Function

This parameter is used to check the manipulated variable for the cooling control output during operation.

- This parameter cannot be set.
- During heating/cooling control, the manipulated variable on the control output (cooling) is monitored.
- The default is OFF and the manipulated variable is not displayed.



Monitor

Control	Monitor range	Unit
Heating/cooling	0.0 to 105.0	%



■ **Related Parameters**

Standard or heating/cooling (initial setting level): Page 204

MV display (advanced function setting level): Page 227

5-4 Adjustment Level

This level is for executing AT (auto-tuning) and other operations, and for set control parameters.

This level provides the basic Controller parameters for PID control (proportional band, integral time, derivative time) and heating/cooling control.

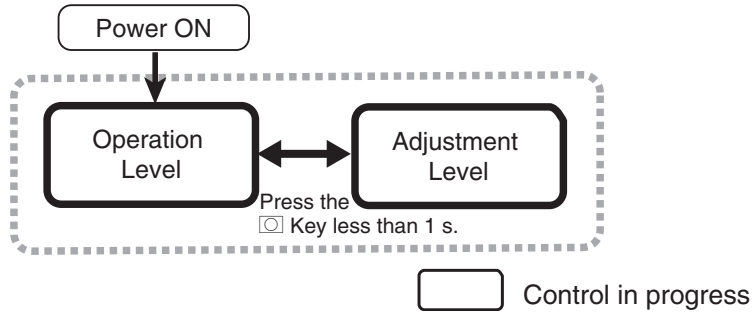

To move to the adjustment level from the operation level, press the Key once.

- The set points 0 to 3 in the adjustment level are the set values for switching the set point during multi-SP input.
- The following parameters are displayed for Controllers with CT Inputs: Heater current monitors, Leakage current monitors, heater burnout detections, HS alarms, and heater overcurrent detections.
- Adjustment level parameters can be changed after setting the Operation/Adjustment Protect parameter to 0. Displays and changing levels are not possible if the Operation/Adjustment Protect parameter is set to 1 to 3. Protection is set in the protect level.

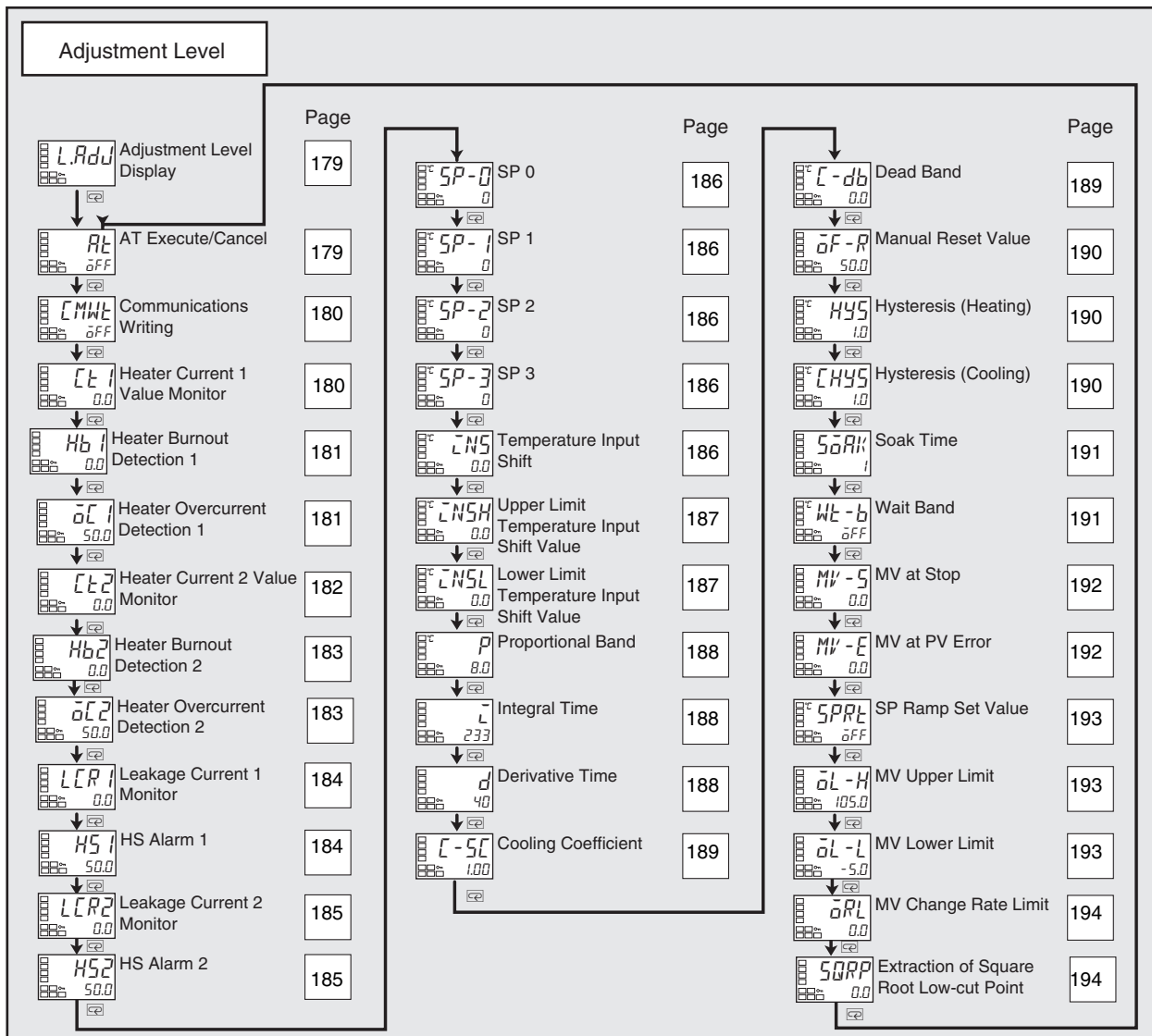

L.RdU

Adjustment Level Display

This parameter is displayed after moving to the adjustment level. When a logic operation is set, a period “.” will be displayed on the No. 2. display.



Function

- This parameter indicates that the adjustment level has been entered. (The Adjustment Level parameter will not be displayed again even if the  Key is pressed in the adjustment level to scroll through the parameters.)

Rt

AT Execute/Cancel

The ramp must be in operation, and 2-PID control must be used. Event Input Assignments 1 and 2 parameters must be other than 100% or 40% AT Execute/Cancel.

This parameter executes auto-tuning (AT).



Function

- The MV is forcibly increased and decreased around the set point to find the characteristics of the control object. From the results, the PID constants are automatically set in the Proportional Band (P), Integral Time (I), and Derivative Time (D) parameters.
- Both 100% AT and 40% AT are supported for AT.
- Only 100% AT can be executed for heating and cooling control.
- This parameter will not be displayed when either 100% or 40% AT execute/cancel is set to be executed using an event input.



Operation

Setting rage	Default
OFF: AT Cancel	OFF
AT-2: 100%AT Execute	
AT-1: 40%AT Execute	

- This parameter is normally OFF. Press the  Key and select Rt-2 or Rt-1 to execute AT. AT cannot be executed when control is stopped or during ON/OFF control.
- When AT execution ends, the parameter setting automatically returns to OFF.



■ **Related Parameters**

Proportional band, Integral time, Derivative time (adjustment level): Page 188
 PID ON/OFF (initial setting level): Page 204

[MWE]

Communications Writing

Communications must be supported.
The Event Input Assignments 1 and 2 parameters must not be set to enable communications writing.



Function

- This parameter enables/disables writing of parameters to the E5CN from the host (personal computer) using communications.
- This parameter is not displayed if communications write enable/disable is set for execution using an event input assignment 1 and 2.



Setting

- ON: Writing enabled
OFF: Writing disabled
- Default: OFF



■ **Related Parameters**

MB command logic switching (advanced function setting level): Page 229
Communications Unit No., Communications baud rate, Communications data length, Communications parity, Communications stop bits (communications setting level): Page 255

[E 1]

Heater Current 1 Value Monitor

Heater burnout, HS alarms, and heater overcurrent detection must be supported.

Alarm 1 must be assigned.

The HB ON/OFF parameter or Heater Overcurrent Use parameter must be set to ON.



Function

This parameter measures the heater current from the CT input used for detecting heater burnout.

This parameter measures and displays the heater current value.

- Heater burnouts or heater overcurrent are not detected if the control output (heating) ON time is 100 ms or less.

Monitor range	Unit
0.0 to 55.0	A

- FFFF is displayed when 55.0 A is exceeded.
- If a heater burnout detection 1 or heater overcurrent detection 1 alarm is output, the HA indicator will light and the No. 1 display for the heater current 1 value monitor will flash.



Monitor



■ **Related Parameters**

Heater burnout detection 1, Heater burnout detection 2 (adjustment level): Pages 181, and 183

HB ON/OFF (advanced function setting level): Page 222

Heater overcurrent detection 1, Heater overcurrent detection 2 (adjustment level): Pages 181, and 183

Heater overcurrent use (advanced function setting level): Page 246

Error displays [E 1]: Page 283

Hb 1

Heater Burnout Detection 1

Heater burnout, HS alarms, and heater overcurrent detection must be supported.
Alarm 1 must be assigned.
The HB ON/OFF parameter must be set to ON.



Function



Setting

This parameter sets the current for the heater burnout alarm to be output.

- The heater burnout alarm is output when the heater current value falls below the setting of this parameter.
- When the set value is 0.0, the heater burnout alarm output is turned OFF. When the set value is 50.0, the heater burnout alarm output is turned ON.

Setting range	Unit	Default
0.0 to 50.0	A	0.0



■ **Related Parameters**

Heater current 1 value monitor (adjustment level): Page 180

Heater burnout detection, Heater burnout latch, Heater burnout hysteresis (advanced function setting level): Page 222

āC 1

Heater Overcurrent Detection 1

Heater burnout, HS alarms, and heater overcurrent detection must be supported.
Alarm 1 must be assigned.
The Heater Overcurrent Use ON/OFF parameter must be set to ON.



Function



Setting

This parameter sets the current value for heater overcurrent alarm outputs.

- A heater overcurrent alarm is output when the heater current exceeds the value set for this parameter.
- When the set value is 50.0, the heater overcurrent alarm is turned OFF. When the set value is 0.0, the heater overcurrent alarm is turned ON.

Setting range	Unit	Default
0.0 to 50.0	A	50.0



■ **Related Parameters**

Heater current 1 value monitor (adjustment level): Page 180

Heater overcurrent use, Heater overcurrent latch, Heater overcurrent hysteresis (advanced function setting level): Page 222

ⒺⒺ

Heater Current 2 Value Monitor

Heater burnout, HS alarms, and heater overcurrent detection must be supported (two CTs).
 Alarm 1 must be assigned.
 The HB ON/OFF or Heater Overcurrent Use parameter must be set to ON.



Function



Monitor

This parameter measures the heater current from the CT input used for detecting heater burnout.

This parameter measures and displays the heater current value.

- Heater burnouts and heater overcurrent are not detected if the control output (heating) ON time is 100 ms or less.

Monitor range	Unit
0.0 to 55.0	A

- *FFFF* is displayed when 55.0 A is exceeded.
- If a heater burnout detection 2 or heater overcurrent detection 2 alarm is output, the HA indicator will light and the No. 1 display for the heater current 2 value monitor will flash.



■ **Related Parameters**

Heater burnout detection 1, Heater burnout detection 2 (adjustment level): Pages 181, and 183

HB ON/OFF (advanced function setting level): Page 222

Heater overcurrent detection 1, Heater overcurrent detection 2 (adjustment level): Pages 181, and 183

Heater overcurrent use (advanced function setting level): Page 246

Error Displays ⒺⒺ: Page 283

Hb2

Heater Burnout Detection 2

Heater burnout, HS alarms, and heater overcurrent detection must be supported (two CTs). Alarm 1 must be assigned. The HB ON/OFF parameter must be set to ON.



Function



Setting

This parameter sets the current for the heater burnout alarm to be output.

- The heater burnout alarm is output when the heater current value falls below the setting of this parameter.
- When the set value is 0.0, the heater burnout alarm output is turned OFF. When the set value is 50.0, the heater burnout alarm output is turned ON.

Setting range	Unit	Default
0.0 to 50.0	A	0.0



■ Related Parameters

Heater current 2 value monitor (adjustment level): Page 182

HB ON/OFF, Heater burnout latch, Heater burnout hysteresis (advanced function setting level): Page 222

ō[2

Heater Overcurrent Detection 2

Heater burnout, HS alarms, and heater overcurrent detection must be supported (two CTs). Alarm 1 must be assigned. The Heater Overcurrent Use parameter must be set to ON.



Function



Setting

This parameter sets the current value for heater overcurrent alarm outputs.

- A heater overcurrent alarm is output when the heater current exceeds the value set for this parameter.
- When the set value is 50.0, the heater overcurrent alarm is turned OFF. When the set value is 0.0, the heater overcurrent alarm is turned turn ON.

Setting range	Unit	Default
0.0 to 50.0	A	50.0



■ Related Parameters

Heater current 2 value monitor (adjustment level): Page 180

Heater overcurrent use, Heater overcurrent latch, Heater overcurrent hysteresis (advanced function setting level): Page 222

*LCR 1***Leakage Current 1 Monitor**

Heater burnout, HS alarms, and heater overcurrent detection must be supported.
Alarm 1 must be assigned.
The HS Alarm parameter must be set to ON.



Function

This parameter measures the heater current from the CT input used for detecting SSR short-circuits.

This parameter measures and displays the heater current when the heater is OFF.

- HS alarms are not detected if the control output (heating) OFF time is 100 ms or less.



Monitor

Monitor range	Unit
0.0 to 55.0	A

- *FFFF* is displayed when 55.0 A is exceeded.
- If an HS alarm 1 alarm is output, the HA indicator will light and the No. 1 display for the leakage current 1 monitor will flash.



See

■ **Related Parameters**

HS alarm 1, HS alarm 2 (adjustment level): Page 184

HS alarm use (advanced function setting level): Page 235

Error Displays *LCR 1*: Page 283

*HS 1***HS Alarm 1**

Heater burnout, HS alarms, and heater overcurrent detection must be supported.
Alarm 1 must be assigned.
The HS Alarm parameter must be set to ON.



Function

This parameter sets the current for the HS alarm to be output.

- An HS alarm is output when the leakage current value exceeds the setting of this parameter.
- When the set value is 50.0, the HS alarm output is turned OFF. When the set value is 0.0, the HS alarm output is turned ON.



Setting

Setting range	Unit	Default
0.0 to 50.0	A	50.0



See

■ **Related Parameters**

Leakage current 1 monitor (adjustment level): Page 184

HS alarm, HS alarm latch, HS alarm hysteresis (advanced function setting level): Page 235

LCR2

Leakage Current 2 Monitor

Heater burnout, HS alarms, and heater overcurrent detection must be supported (two CTs). Alarm 1 must be assigned. The HS Alarm parameter must be set to ON.



Function

This parameter measures the heater current from the CT input used for detecting SSR short-circuits.

This parameter measures and displays the heater current value.

- HS alarms are not detected if the control output (heating) OFF time is 100 ms or less.



Monitor

Monitor range	Unit
0.0 to 55.0	A

- FFFF is displayed when 55.0 A is exceeded.
- If an HS alarm 2 alarm is output, the HA indicator will light and the No. 1 display for the leakage current 2 monitor will flash.



■ **Related Parameters**

HS alarm 1, HS alarm 2 (adjustment level): Page 184

HS alarm use (advanced function setting level): Page 235

Error Displays LCR2: Page 283

HS2

HS Alarm 2

Heater burnout, HS alarms, and heater overcurrent detection must be supported (two CTs). Alarm 1 must be assigned. The HS Alarm parameter must be set to ON.



Function

This parameter sets the current for the HS alarm to be output.

- An HS alarm is output when the leakage current value exceeds the setting of this parameter.
- When the set value is 50.0, the HS alarm output is turned OFF. When the set value is 0.0, the HS alarm output will turn ON.



Setting

Setting range	Unit	Default
0.0 to 50.0	A	50.0



■ **Related Parameters**

Leakage current 2 monitor (adjustment level): Page 185

HS alarm use, HS alarm latch, HS alarm hysteresis (advanced function setting level): Page 235

SP-0

SP 0

SP-1

SP 1

SP-2

SP 2

SP-3

SP 3

The Number of Multi-SP Uses parameter must be set to 1 or 2. The Multi-SP Uses parameter must be set to ON.



Function

These parameters set the set points when the multi-SP function is used.

The values set in these parameters can be selected by operating the keys on the front panel or by using event inputs.

- When the set point has been changed, the set value of the set point (0 to 3) selected by the multi-SP inputs is also changed to the same value.
- The decimal point position depends on the selected sensor. During analog input, it depends on the Decimal Point parameter setting.



Setting

Setting range	Unit	Default
SP lower limit to SP upper limit	EU	0



See

■ Related Parameters

Process value/set point (operation level): Page 165

Input type (initial setting level): Page 200

Number of multi-SP uses: Page 213, Event input assignment 1 and 2 (initial setting level): Page 216, Multi-SP uses: Page 220 (advanced function setting level)

INS

Temperature Input Shift

The Input Type parameter must be set for a thermocouple or resistance thermometer, and the Input Shift Type parameter must be set to a one-point shift.



Function

Sometimes an error occurs between the set point and the actual temperature. To offset this, a compensated value can be obtained by adding an input shift value to the input. The compensated value is displayed as the measurement value and used for control.

The entire input range is shifted by a fixed rate (1-point shift). If the input shift value is set to -1°C , control will be performed for a value 1°C lower than the measured temperature.



Setting

Setting range	Unit	Default
-199.9 to 999.9	$^{\circ}\text{C}$ or $^{\circ}\text{F}$	0.0



See

■ Related Parameters

Input type (initial setting level): Page 200

Input shift type (advanced function setting level): Page 233

$\bar{N}SH$	Upper-limit Temperature Input Shift Value	The Input Type parameter must be set for a thermocouple or resistance thermometer and the Input Shift Type parameter must be set to a 2-point shift, or the Input Type parameter must be set for an infrared sensor.
$\bar{N}SL$	Lower-limit Temperature Input Shift Value	

These parameters are used to shift the input temperature at two points: an upper-limit temperature and a lower-limit temperature (as opposed to the Temperature Input Shift parameter, which shifts the input temperature by setting the shift for only one point). A 2-point shift enables more accurate offset of the input range compared with a 1-point shift if the input shift values at the upper and lower limits differ.

This parameter sets input shift values for the upper and lower limits (2-point shift) of the input range.



Function



Setting

Setting range	Unit	Default
-199.9 to 999.9	°C or °F	0.0

■ **Related Parameters**

Input type (initial setting level): Page 200

Input shift type (advanced function setting level): Page 233



See

<p><i>P</i></p> <p><i>I</i></p> <p><i>d</i></p>	<p>Proportional Band</p> <p>Integral Time</p> <p>Derivative Time</p>	<p>The control must be set to 2-PID control.</p>
---	---	--



Function

These parameters set PID control constants. PID constants are automatically set when AT or ST is executed.

P action: Refers to control in which the MV is proportional to the deviation (control error).

I action: Refers to a control action that is proportional to the time integral of the deviation. With proportional control, there is normally an offset (control error). Proportional action is thus used in combination with integral action. As time passes, this control error disappears, and the control temperature (process value) comes to agree with the set point.

D action: Refers to a control action that is proportional to the time derivative of the control error. The proportional control and integral control correct for errors in the control result, and thus the control system is late in responding to sudden changes in temperature. The derivative action increases the MV in proportion to the slope of the change in the temperature as a corrective action.



Setting

Parameter name	Models	Setting range		Unit	Default
Proportional Band	Controllers with Thermocouple/Resistance Thermometer Multi-inputs	0.1 to 999.9		°C or °F (See note 1.)	8.0
	Controllers with Analog Inputs			%FS	10.0
Integral Time		0 to 3999		Second	233
Derivative Time		RT is OFF.	0 to 3999	Second	40
		RT is ON.	0.0 to 999.9	Second	40.0

- Note**
- (1) Set "None" as the unit for Controllers with Analog Inputs.
 - (2) If the settings for RT (robust tuning) are changed, the proportional band (P), integral time (I), and derivative time (D) will be initiated.



■ **Related Parameters**

AT execute/cancel (adjustment level): Page 179

[- 5]

Cooling Coefficient

The control must be heating/cooling control and 2-PID control.



Function

If the heating characteristics and cooling characteristics of the control object are very different and good control characteristics cannot be achieved with the same PID constants, the cooling coefficient can be used to adjust the proportional band (P) for the control output assigned to the cooling side.

- In heating/cooling control, the proportional band P for the cooling control output is calculated using the following formula to set the cooling coefficient:
Cooling control output side P = Cooling coefficient × P (proportional band)
- When the Automatic Cooling Coefficient Adjustment parameter is set to ON, the cooling coefficient is set automatically when AT is executed. If there is strong non-linear gain for the cooling characteristics, however, it may not be possible to obtain the optimum cooling coefficient at the Controller.



Setting

Setting range	Unit	Default
0.01 to 99.99	None	1.00



See

■ **Related Parameters**

Proportional band (adjustment level): Page 188

Automatic cooling coefficient adjustment (advanced function setting level): Page 245

[- db

Dead Band

The control system must be set to heating/cooling control.



Function

This parameter sets the output dead band width for heating/cooling control. A negative setting sets an overlapping band.

- This parameter sets an area in which the control output is 0 centering around the set point for a heating/cooling control.
- During temperature input, the decimal point position depends on the currently selected sensor, and during analog input it depends on the Decimal Point parameter setting.



Setting

Model	Setting range	Unit	Default
Controllers with Thermocouple/Resistance Thermometer Universal Inputs	-199.9 to 999.9	°C or °F (See note.)	0.0
Controllers with Analog Inputs	-19.99 to 99.99	%FS	0.00

Note Set "None" as the unit for Controllers with Analog Inputs.

$\bar{\alpha}F-R$

Manual Reset Value

The control must be standard control and 2-PID control.
The Integral Time parameter must be set to 0.



Function

- This parameter sets the required manipulated variable to remove offset during stabilization of P or PD control.



Setting

Setting range	Unit	Default
0.0 to 100.0	%	50.0



■ **Related Parameters**

Integral time (adjustment level): Page 188
PID ON/OFF (initial setting level): Page 204

HYS

Hysteresis (Heating)

The control must be ON/OFF control.
For the Hysteresis (Cooling) parameter, the control must be heating/cooling control.

[*HYS*

Hysteresis (Cooling)



Function

This parameter sets the hysteresis for ensuring stable operation at the ON/OFF switching point.

- For standard control, use the Hysteresis (Heating) parameter. The Hysteresis (Cooling) parameter cannot be used.
- For heating/cooling control, the hysteresis can be set independently for heating/cooling. The Hysteresis (Heating) parameter is used for the heating side, and the Hysteresis (Cooling) parameter is used for the cooling side.



Setting

Parameter name	Model	Setting range	Unit	Default
Hysteresis (Heating)	Controllers with Thermocouple/Resistance Thermometer Universal Inputs	0.1 to 999.9	°C or °F (See note.)	1.0
	Controllers with Analog Inputs	0.01 to 99.99	%FS	0.10
Hysteresis (Cooling)	Controllers with Thermocouple/Resistance Thermometer Universal Inputs	0.1 to 999.9	°C or °F (See note.)	1.0
	Controllers with Analog Inputs	0.01 to 99.99	%FS	0.10

Note Set "None" as the unit for Controllers with Analog Inputs.



■ **Related Parameters**

PID ON/OFF, Standard or heating/cooling (initial setting level): Page 204

50R11

Soak Time

The Program Pattern parameter must not be set to OFF.



Function

- This parameter sets the time for the control operation when using the simple program function.



Setting

Setting range	Unit	Default
1 to 9999	min or h	1



■ **Related Parameters**

- Program start, Soak time remain (operation level): Page 171
- Wait band (adjustment level): Page 191
- Program pattern (initial setting level): Page 205
- Soak time unit (advanced function setting level): Page 243

WT-b

Wait Band

The Program Pattern parameter must not be set to OFF.



Function

- This parameter sets the stable band within which the soak time is measured for the simple program function.



Setting

Model	Setting range	Unit	Default
Controllers with Thermocouple/Resistance Thermometer Universal Inputs	OFF or 0.1 to 999.9	°C or °F (See note.)	OFF
Controllers with Analog Inputs	OFF or 0.01 to 99.99	%FS	

Note Set "None" as the unit for Controllers with Analog Inputs.



■ **Related Parameters**

- Program start, Soak time remain (operation level): Page 171
- Soak time (adjustment level): Page 191
- Program pattern (initial setting level): Page 205
- Soak time unit (advanced function setting level): Page 243

MV-5**MV at Stop**

The control must be set to 2-PID control.
The MV at Stop and Error Addition parameter must be ON.



Function



Setting

- This parameter sets the MV to use when the RUN/STOP status changes from RUN to STOP.

Setting range	Unit	Default
-5.0 to 105.0 for standard control	%	0.0
-105.0 to 105.0 (heating/cooling control)		

■ **Related Parameters**

RUN/STOP (operation level): Page 172

MV at stop and error addition (advanced function setting level): Page 233

**MV-E****MV at PV Error**

The control must be set to 2-PID control.
The MV at Stop and Error Addition parameter must be ON.



Function



Setting

- This parameter sets the MV to use when an input error occurs.

Setting range	Unit	Default
-5.0 to 105.0 for standard control	%	0.0
-105.0 to 105.0 (heating/cooling control)		

■ **Related Parameters**

MV at stop and error addition (advanced function setting level): Page 233



SPRt

SP Ramp Set Value

The ST parameter must be set to OFF.



- This parameter sets the rate of change during SP ramp operation. Set the maximum permissible change width per unit of time as the SP ramp set value. The SP ramp function is disabled if this parameter is set to OFF.
- During temperature input, the decimal point position of the SP ramp set value is dependent on the currently selected sensor, and during analog input it is dependent on scaling.



Setting range	Unit	Default
OFF or 1 to 9999	EU/s, EU/minute, or EU/h	OFF



■ **Related Parameters**

Input type: Page 200, Scaling upper limit, Scaling lower limit, Decimal point (initial setting level): Page 202, ST: Page 205 (initial setting level)
 SP ramp time unit (advanced function setting level): Page 220

oL-H

MV Upper Limit

The control must be set to 2-PID control.

oL-L

MV Lower Limit

The ST parameter must be set to OFF.



- The MV Upper Limit and MV Lower Limit parameters set the upper and lower limits of the manipulated variable. When the calculated manipulated variable exceeds the upper or lower limit value, the upper or lower limit value will be the output level.
- MV Upper Limit
 The setting ranges during standard control and heating/cooling control are different.



Control method	Setting range	Unit	Default
Standard	MV lower limit + 0.1 to 105.0	%	105.0
Heating/cooling	0.0 to 105.0		

- MV Lower Limit
 The setting ranges during standard control and heating/cooling control are different. The manipulated variable for the cooling control output side during heating/cooling control is expressed as a negative value.

Control method	Setting range	Unit	Default
Standard	-5.0 to MV upper limit - 0.1	%	-5.0
Heating/cooling	-105.0 to 0.0		-105.0



■ **Related Parameters**

PID ON/OFF: Page 204, ST: Page 205 (initial setting level)

oRL

MV Change Rate Limit

2-PID control must be used.
ST must be OFF.



Function

- The MV Change Rate Limit parameter sets the maximum allowable variation in the MV per second. If the change in the MV exceeds this setting, the MV will be changed by the MV change rate limit until the calculated value is reached. If the limit is set to 0.0, this function will be disabled.
- The MV Change Rate Limit parameter will not operate in the following situations.
 - In manual mode
 - During ST execution (Cannot be set when ST is ON.)
 - During AT execution
 - During ON/OFF control
 - While stopped (MV output during STOP)
 - During MV output when error occurs



Setting

Setting range	Unit	Default
0.0 to 100.0	%/s	0.0



■ **Related Parameters**

Proportional band (adjustment level): Page 188

5QRP

Extraction of Square Root Low-cut Point

The input type must be an analog input, and the Extraction of Square Root Enable parameter must be set to ON.



Function

- This parameter sets the extraction of square root low-cut point used for the inputs. The data after extracting the square root is shown below.
- The low-cut point is used for extracting the square root for flowrate sensors.

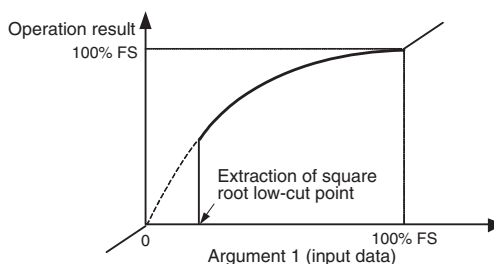

Setting

Setting range	Unit	Default
0.0 to 100.0	%	0.0



■ **Related Parameters**

Extraction of square root enable (initial setting level): Page 216

5-5 Monitor/Setting Item Level

Monitor/setting items can be displayed by means of the function key when the PF Setting parameter (advanced function setting level) is set to PFDP: Monitor/Setting Item (for the E5AN/EN only).

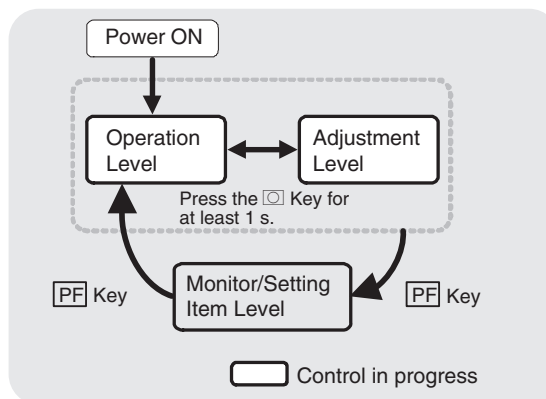

Monitor/Setting Item Display 1 to 5

The PF Setting parameter must be set to PFDP, and the Monitor/Setting Item 1 to 5 parameters must not be set to OFF.



- When the PF Key is set to display monitor/setting items, pressing the PF Key will display in order the contents of the Monitor/Setting Item 1 to 5 parameters. The contents of these parameters are shown in the following table. For the setting (monitor) ranges, refer to the applicable parameters.

Set value	Setting	Remarks	
		Monitor/Setting	Symbol
0	Disabled		---
1	PV/SP/Multi-SP	Can be set. (SP)	---
2	PV/SP/MV	Can be set. (SP)	---
3	PV/SP /Soak time remain	Can be set. (SP)	---
4	Proportional band (P)	Can be set.	<i>P</i>
5	Integral time (I)	Can be set.	<i>I</i>
6	Derivative time (D)	Can be set.	<i>d</i>
7	Alarm value 1	Can be set.	<i>AL - 1</i>
8	Alarm value upper limit 1	Can be set.	<i>AL 1H</i>
9	Alarm value lower limit 1	Can be set.	<i>AL 1L</i>
10	Alarm value 2	Can be set.	<i>AL - 2</i>
11	Alarm value upper limit 2	Can be set.	<i>AL 2H</i>
12	Alarm value lower limit 2	Can be set.	<i>AL 2L</i>
13	Alarm value 3	Can be set.	<i>AL - 3</i>
14	Alarm value upper limit 3	Can be set.	<i>AL 3H</i>
15	Alarm value lower limit 3	Can be set.	<i>AL 3L</i>

■ Related Parameters

PF setting (advanced function setting level): Page 247

Monitor/setting items 1 to 5 (advanced function setting level): Page 248



5-6 Manual Control Level

The manipulated variable can be set in manual mode while the PV/MV parameter is displayed.

The final MV used in automatic mode will be used as the initial manual MV when moving from automatic mode to manual mode. In manual mode, the change value will be saved immediately and reflected in the actual MV.

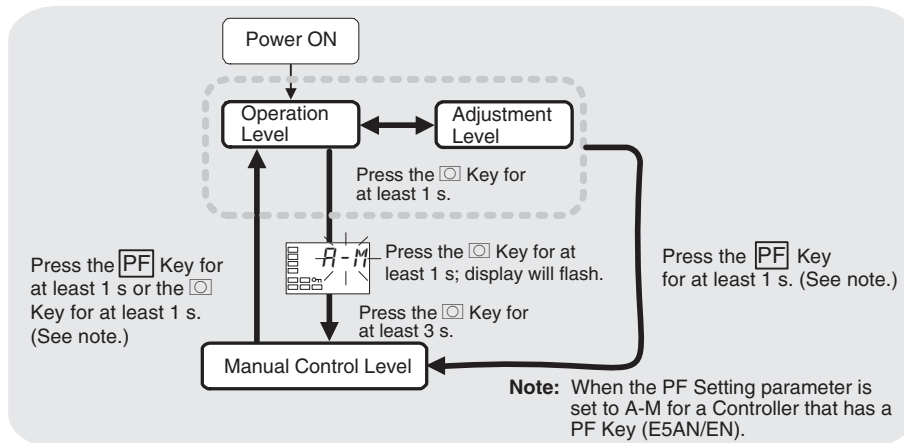

To move from the operation level to the manual control level, press the Key for at least three seconds with the Auto/Manual Switch parameter displayed. In addition, this operation can be performed using the PF Key by setting the PF Key parameter (advanced function setting level) to A-M (Auto/Manual). For details on the setting method, refer to 4-13 Performing Manual Control.

This setting cannot be made during ON/OFF operation.

- The MANU indicator will light during manual control.
- It is not possible to move to any displays except for the PV/MV parameter during manual operation.
- To return to the operation level, press the Key or the PF Key in the manual control level for at least one second.

PV/MV (Manual MV)



The manual control level display appears as shown below.

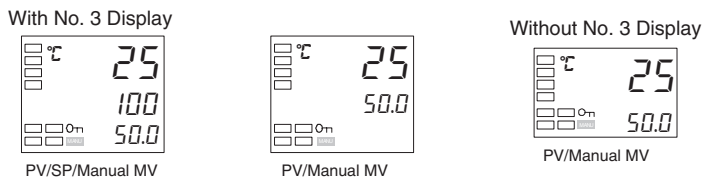

Note: When the PV/SP Display Screen Selection parameter is 0.

	Monitor range	Unit
Process value	Temperature: According to indication range for each sensor. Analog: Scaling lower limit -5% FS to Scaling upper limit +5% FS (Refer to page 303.)	EU
Set point	SP lower limit to SP upper limit	EU

	Setting range		Unit
MV (manual MV)	Standard control	-5.0 to 105.0 (See note.)	%
	Heating/cooling control	-105.0 to 105.0 (See note.)	

Note When the Manual MV Limit Enable parameter is set to ON, the setting range will be the MV lower limit to the MV upper limit.



■ **Related Parameters**

Standard or heating/cooling (initial setting level): Page 204

5-7 Initial Setting Level

This level is used to set up the basic Temperature Controller specifications. In this level, you can set the Input Type parameter to set the sensor input to be connected, limit the setting range of set points, set the alarm modes, and perform other operations.

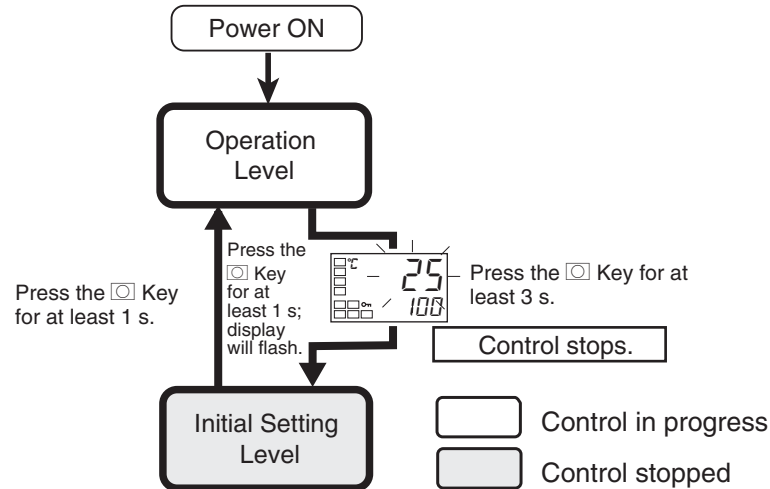

To move from the operation level to the initial setting level, press the \square Key for at least three seconds with any parameter displayed except for the Auto/Manual Switch parameter.

- The initial setting level is not displayed when the Initial Setting/Communications Protect parameter is set to 2. It can be used when the Initial Setting/Communications Protect parameter is set to 0 or 1.
- If the Input Type parameter is set for an analog input, the following parameters will be set: Scaling upper limit, Scaling lower limit, and Decimal point.

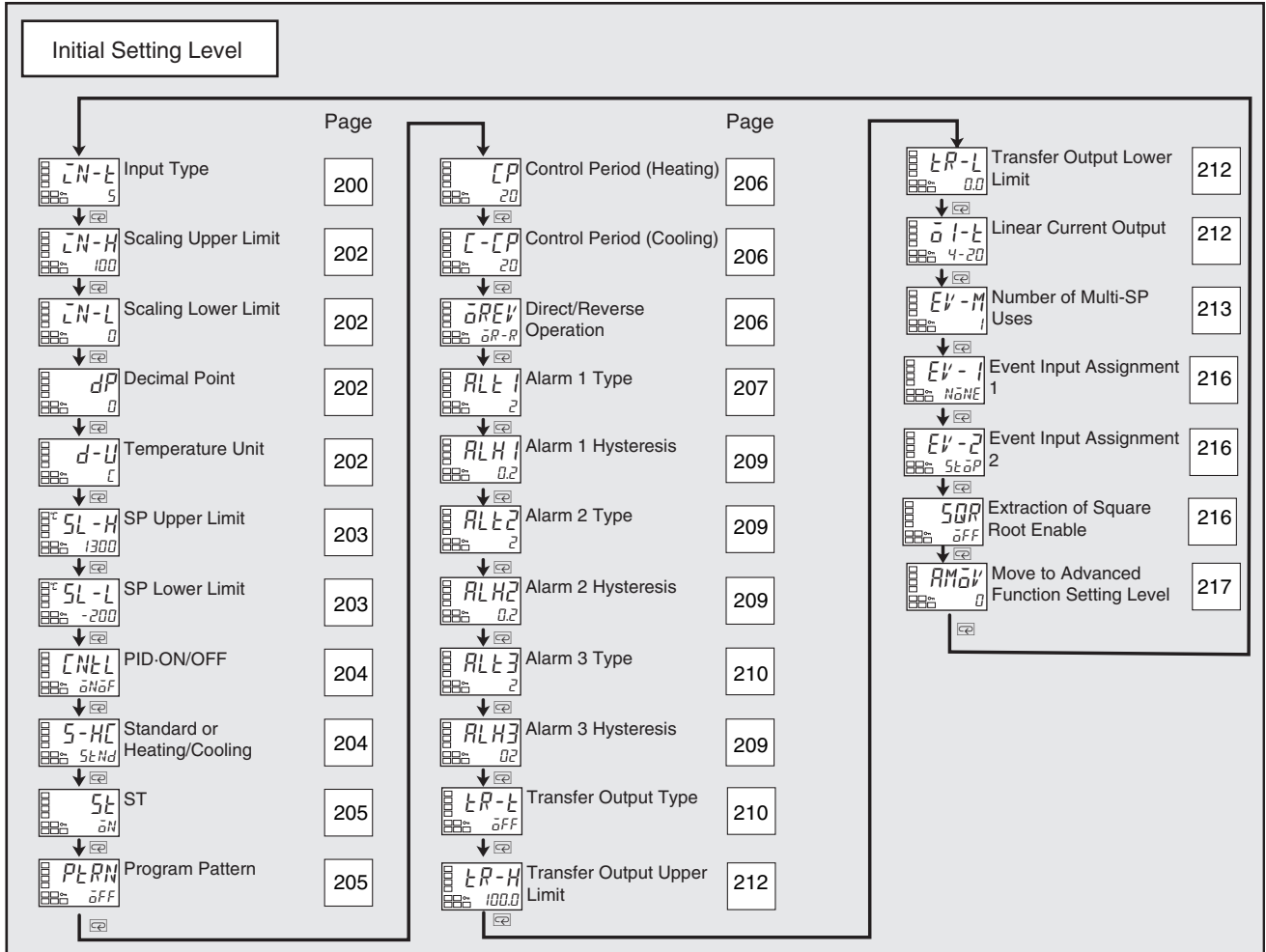

LN-L Input Type



Function



Setting

- This parameter sets the type of sensor.
- When this parameter is changed, the set point limiter is changed to the defaults. If the limiter must be specified, set the SP Upper Limit and SP Lower Limit parameters (initial setting level) again.
- Set one of the set values from the following table. The defaults are as follows:
 Controllers with Thermocouple/Resistance Thermometer Universal Inputs: 5 (K thermocouple)
 Controllers with Analog Inputs: □ (current input, 4 to 20 mA)
- If a platinum resistance thermometer is mistakenly connected while a setting for other than a platinum resistance thermometer is in effect, S.ERR will be displayed. To clear the S.ERR display, check the wiring and then cycle the power.

	Input type	Specifications	Set value	Input temperature range
Controllers with Thermocouple/Resistance Thermometer Multi-inputs	Platinum resistance thermometer	Pt100	0	-200 to 850 (°C)/-300 to 1,500 (°F)
			1	-199.9 to 500.0 (°C)/-199.9 to 900.0 (°F)
		JPt100	2	0.0 to 100.0 (°C)/0.0 to 210.0 (°F)
			3	-199.9 to 500.0 (°C)/-199.9 to 900.0 (°F)
	Thermocouple	K	4	0.0 to 100.0 (°C)/0.0 to 210.0 (°F)
			5	-200 to 1,300 (°C)/-300 to 2,300 (°F)
		J	6	-20.0 to 500.0 (°C)/0.0 to 900.0 (°F)
			7	-100 to 850 (°C)/-100 to 1,500 (°F)
		T	8	-20.0 to 400.0 (°C)/0.0 to 750.0 (°F)
			9	-200 to 400 (°C)/-300 to 700 (°F)
		E	10	-199.9 to 400.0 (°C)/-199.9 to 700.0 (°F)
			11	-200 to 600 (°C)/-300 to 1,100 (°F)
		L	12	-100 to 850 (°C)/-100 to 1,500 (°F)
			13	-200 to 400 (°C)/-300 to 700 (°F)
		U	14	-199.9 to 400.0 (°C)/-199.9 to 700.0 (°F)
			15	-200 to 1,300 (°C)/-300 to 2,300 (°F)
		R	16	0 to 1,700 (°C)/0 to 3,000 (°F)
			17	0 to 1,700 (°C)/0 to 3,000 (°F)
	S	18	100 to 1,800 (°C)/300 to 3,200 (°F)	
		19	0 to 90 (°C)/0 to 190 (°F)	
	Infrared Temperature Sensor ES1B	20	0 to 120 (°C)/0 to 240 (°F)	
		21	0 to 165 (°C)/0 to 320 (°F)	
		22	0 to 260 (°C)/0 to 500 (°F)	
		23	One of the following ranges depending on the scaling. -1,999 to 9,999 -199.9 to 999.9	
	Analog input	0 to 50 mV	24	0 to 2,300 (°C)/0 to 3,200 (°F)
W		25	0 to 1,300 (°C)/0 to 2,300 (°F)	
Thermocouple	PLII			

	Input type	Specifications	Set value	Input temperature range
Controllers with Analog Inputs	Current input	4 to 20 mA	0	One of the following ranges depending on the scaling. -1,999 to 9,999 -199.9 to 999.9 -19.99 to 99.99 -1.999 to 9.999
		0 to 20 mA	1	
	Voltage input	1 to 5 V	2	
		0 to 5 V	3	
		0 to 10 V	4	



■ Related Parameters

Temperature unit, Set point upper limit, Set point lower limit (initial setting level): Page 202

┌N-H
┌N-L
dP

Scaling Upper Limit
Scaling Lower limit
Decimal Point

The input type must be set for an analog input.



- These parameters can be used when the input type is set for an analog input.
- When an analog input is used, scaling is performed. Set the upper limit in the Scaling Upper Limit parameter and the lower limit in the Scaling Lower Limit parameter.
- The Decimal Point parameter specifies the decimal point position of parameters (set point, etc.) whose unit is EU.
- Scaling Upper Limit, Scaling Lower Limit



Parameter name	Setting range	Unit	Default
Scaling Upper Limit	Scaling lower limit + 1 to 9999	None	100
Scaling Lower Limit	-1999 to scaling upper limit - 1	None	0

- Decimal Point

Parameter name	Model	Setting range	Default
Decimal Point	Controllers with Thermocouple/Resistance Thermometer Universal Inputs	0 to 1	0
	Controllers with Analog Inputs	0 to 3	0

Set value	Settings	Example
0	0 digits past decimal point	1234
1	1 digits past decimal point	123.4
2	2 digits past decimal point	12.34
3	3 digits past decimal point	1.234

■ **Related Parameters**

Input type (initial setting level): Page 200



d-U

Temperature Unit

The input type must be set for a temperature input.



- Set the temperature input unit to either °C or °F.



Setting range	Default
┌: °C, F: °F	┌

■ **Related Parameters**

Input type (initial setting level): Page 200



5L -H
5L -L

SP Upper Limit
SP Lower Limit



- These parameters set the upper and lower limits of the set points. A set point can be set within the range defined by the upper and lower limit set values in the SP Upper Limit and SP Lower Limit parameters. If these parameters are reset, any set point that is outside of the new range will be forcibly changed to either the upper limit or the lower limit.
- When the temperature input type and temperature unit have been changed, the set point upper limit and set point lower limit are forcibly changed to the upper and lower limits of the sensor.
- During temperature input, the decimal point position depends on the currently selected sensor, and during analog input it depends on the Decimal Point parameter setting.



Controllers with Thermocouple/Resistance Thermometer Universal Inputs

Parameter name		Setting range	Unit	Default
Set Point Upper Limit	Temperature	SP lower limit + 1 to Input setting range upper limit	EU	1300
	Analog	SP lower limit + 1 to scaling upper limit	EU	100
Set Point Lower Limit	Temperature	Input setting range lower limit to SP upper limit - 1	EU	-200
	Analog	Scaling lower limit to SP upper limit - 1	EU	0

Controllers with Analog Inputs

Parameter name	Setting range	Unit	Default
Set Point Upper Limit	SP lower limit + 1 to scaling upper limit	EU	100
Set Point Lower Limit	Scaling lower limit to SP upper limit - 1	EU	0



■ **Related Parameters**

Input type: Page 200, Temperature unit: Page 202 (initial setting level)

ENL

PID ON/OFF



Function

- This parameter selects 2-PID control or ON/OFF control.
- The auto-tuning and self-tuning functions can be used in 2-PID control.



Setting

Setting range	Default
$P\bar{L}d$: 2-PID, $\bar{a}N\bar{a}F$: ON/OFF	$\bar{a}N\bar{a}F$



See

■ Related Parameters

AT execute/cancel: Page 179, Manual reset value, Hysteresis (heating), and Hysteresis (cooling): Page 190 (adjustment level)

ST stable range (advanced function setting level): Page 224

5-HC

Standard or Heating/Cooling



Function

- This parameter selects standard control or heating/cooling control.
- When heating/cooling control is selected for the E5CN or E5CN-U, the auxiliary output 2 terminal (SUB2) is assigned as the control output (cooling).
- When heating/cooling control is selected for the E5AN or E5EN, the auxiliary output 3 terminal (SUB3) is assigned as the control output (cooling).
- When heating/cooling control is selected for the E5GN, the auxiliary output 1 terminal (SUB1) is assigned as the control output (cooling).

Note If standard control is selected, set the Control Output 1 Assignment to \bar{a} (control output (heating)) for either direct (cooling) or reverse (heating) operation.



Setting

Setting range	Default
$S\bar{L}N\bar{d}$: Standard, $H-\bar{C}$: Heating/cooling	$S\bar{L}N\bar{d}$



See

■ Related Parameters

MV monitor (heating): Page 175, MV monitor (cooling): Page 176 (operation level)

Cooling coefficient, Dead band: Page 189, Hysteresis (heating), Hysteresis (cooling): Page 190 (adjustment level)

Control period (heat), Control period (cool) (initial setting level): Page 206

Control output 1 assignment: Page 238, Control output 2 assignment, Auxiliary output 1 assignment: Page 240, Auxiliary output 2 assignment: Page 241, Auxiliary output 3 assignment: Page 242 (advanced function setting level)

5t

ST (self-tuning)

The control must be set to a temperature input, standard control, and 2-PID control.



Function

- The ST (self-tuning) function executes tuning from the start of program execution to calculate PID constants matched to the control target. When the ST function is in operation, be sure to turn ON the power supply of the load connected to the control output simultaneously with or before starting Controller operation.
- Auto-tuning can be started during self-tuning.



Setting

Parameter name	Setting range	Unit	Default
ST	$\bar{o}FF$: ST function OFF, $\bar{o}N$: ST function ON	None	$\bar{o}N$



■ **Related Parameters**

Input type: Page 200, PID ON/OFF: Page 204 (initial setting level), ST stable range (advanced function setting level): Page 224

PLRN

Program Pattern

This parameter sets the type of control when using the simple program function.



Function

- If the program pattern is set to $\bar{o}FF$, the simple program will not operate.
- If the program pattern is set to $5t\bar{o}P$, the RUN/STOP status will change to STOP after the soak time has expired. If the program pattern is set to $[\bar{o}Nt$, control will continue in RUN status after the soak time has expired.



Setting

	Setting range	Default
$\bar{o}FF$	Simple program function turned OFF	$\bar{o}FF$
$5t\bar{o}P$	Go to STOP mode at end of program.	
$[\bar{o}Nt$	Continue in RUN mode at end of program.	



■ **Related Parameters**

Program start, Soak time remain: Page 171, RUN/STOP: Page 172 (operation level)

Soak time, Wait band (adjustment level): Page 191

Soak time unit (advanced function setting level): Page 243

\overline{CP} **Control Period (Heating)**

The cooling control output and heating control output must be assigned to relay or voltage outputs (for driving SSR).

The control must be set to 2-PID control.

\overline{CP} **Control Period (Cooling)**

For the Control Period (Cooling) parameter, the control must be set to heating/cooling control.



Function

- These parameters set the output periods. Set the control periods taking the control characteristics and the electrical durability of the relay into consideration.
- For standard control, use the Control Period (Heating) parameter. The Control Period (Cooling) parameter cannot be used.
- When the heating control output is a current output, the Control Period (Heating) parameter cannot be used.
- For heating/cooling control, the control period can be set independently for heating and cooling. The Control Period (Heating) parameter is used for the heating control output, and the Control Period (Cooling) parameter is used for the cooling control output



Setting

Parameter name	Setting range	Unit	Default
Control Period (Heating)	0.5 or 1 to 99	Second	20
Control Period (Cooling)	0.5 or 1 to 99	Second	20



See

■ **Related Parameters**

PID ON/OFF (initial setting level): Page 204

\overline{REV} **Direct/Reverse Operation**



Function

- “Direct operation” refers to control where the manipulated variable is increased when the process value increases. Alternatively, “reverse operation” refers to control where the manipulated variable is increased when the process value decreases.



Setting

Setting range	Default
\overline{R} - \overline{R} : Reverse operation, \overline{R} - d : Direct operation	\overline{R} - \overline{R}

RL1

Alarm 1 Type

Alarm 1 must be assigned.



Function

- Select one of the following alarm 1 types:
Deviation, deviation range, absolute value, LBA, or PV change rate alarm.



Setting

Set value	Alarm type	Alarm output operation		Description of function
		When alarm value X is positive	When alarm value X is negative	
0	Alarm function OFF	Output OFF		No alarm
1 (See note 1.)	Upper- and lower-limit		See note 2.	Set the deviation in the set point by setting the alarm upper limit (H) and alarm lower limit (L).
2	Upper-limit			Set the upward deviation in the set point by setting the alarm value (X).
3	Lower-limit			Set the downward deviation in the set point by setting the alarm value (X).
4 (See note 1.)	Upper- and lower-limit range		See note 3.	Set the deviation in the set point by setting the alarm upper limit (H) and alarm lower limit (L).
5 (See note 1.)	Upper- and lower-limit with standby sequence		See note 4.	A standby sequence is added to the upper- and lower-limit alarm (1). (See note 6.)
6	Upper-limit with standby sequence			A standby sequence is added to the upper-limit alarm (2). (See note 6.)
7	Lower-limit with standby sequence			A standby sequence is added to the lower-limit alarm (3). (See note 6.)
8	Absolute-value upper-limit			The alarm will turn ON if the process value is larger than the alarm value (X) regardless of the set point.
9	Absolute-value lower-limit			The alarm will turn ON if the process value is smaller than the alarm value (X) regardless of the set point.
10	Absolute-value upper-limit with standby sequence			A standby sequence is added to the absolute-value upper-limit alarm (8). (See note 6.)
11	Absolute-value lower-limit with standby sequence			A standby sequence is added to the absolute-value lower-limit alarm (9). (See note 6.)
12	LBA (alarm 1 type only)	---		Refer to page 118. (See note 7.)
13	PV change rate alarm	---		Refer to page 72. (See note 8.)

- Note**
- (1) With set values 1, 4 and 5, the upper- and lower- limit values can be set independently for each alarm type, and are expressed as “L” and “H.”
 - (2) Set value: 1 (Upper- and lower-limit alarm)

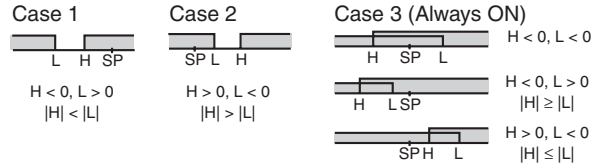

- (3) Set value: 4 (Lower limit range)

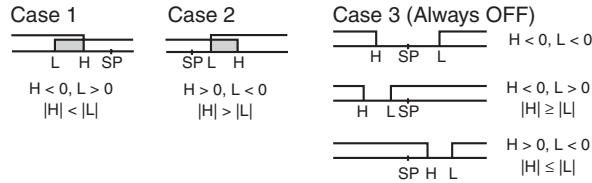

- (4) Set value: 5 (Upper- and lower-limit with standby sequence)
 - For the lower-limit alarms in cases 1 and 2 above, the alarm is normally OFF if upper- and lower-limit hysteresis overlaps.
 - In case 3, the alarm is always OFF.
- (5) Set value: 5 (The alarm is always OFF if upper- and lower-limit alarm hysteresis with standby sequence overlaps.)
- (6) Refer to 4-2-1 *Standby Sequence* for information on the operation of the standby sequence.
- (7) Refer to 4-12-1 *Loop Burnout Alarm (LBA)*
- (8) Refer to *PV Change Rate Alarm* on page 72.
 - Set the alarm type independently for each alarm in the Alarm 1 to 3 Type parameters in the initial setting level. The default is 2 (Upper-limit alarm).



■ **Related Parameters**

Alarm value 1: Page 172, Alarm value upper limit 1, Alarm value lower limit 1: Page 174 (operation level)
 Standby sequence reset: Page 221, Auxiliary output 1 open in alarm: Page 222, Alarm 1 latch: Page 227 (advanced function setting level), Alarm 1 hysteresis: Page 209 (initial setting level)

ALH1	Alarm 1 Hysteresis	Alarm 1 must be assigned. The alarm 1 type must not be 0, 12, or 13.
ALH2	Alarm 2 Hysteresis	Alarm 2 must be assigned. The alarm 2 type must not be 0, 12, or 13.
ALH3	Alarm 3 Hysteresis	Alarm 3 must be assigned. The alarm 3 type must not be 0, 12, or 13.



- These parameters set the hysteresis for alarms 1, 2, and 3.



Models	Setting range	Unit	Default
Model with thermocouple/resistance thermometer universal input	0.1 to 999.9	°C or °F (See note.)	0.2
Model with analog Input	0.01 to 99.99	%FS	0.02

Note Set “None” as the unit for analog inputs.



■ **Related Parameters**

Alarm value 1 to 3: Page 173, Alarm value upper limit 1 to 3, Alarm value lower limit 1 to 3: Page 174 (operation level)
 Alarm 1 to 3 type (initial setting level): Pages 207 to 210
 Standby sequence reset: Page 221, Auxiliary output 1 to 3 open in alarm: Page 222, Alarm 1 to 3 latch: Page 227 (advanced function setting level)

ALL2	Alarm 2 Type	Alarm 2 must be assigned.
-------------	---------------------	---------------------------



- Select one of the following four alarm 2 types:
 Deviation, deviation range, absolute value, or PV change rate alarm.



Refer to the alarm 1 type list. The 12: LBA (Loop Burnout Alarm) setting in that list cannot be used.



■ **Related Parameters**

Alarm value 2: Page 173, Alarm value upper limit 2, Alarm value lower limit 2: Page 174 (operation level)
 Standby sequence reset: Page 221, Auxiliary output * open in alarm: Page 222, Alarm 2 hysteresis: Page 209, Alarm 2 latch: Page 227 (advanced function setting level)

AL3

Alarm 3 Type

Alarm 3 must be assigned.



Function

- Select one of the following four alarm 3 types:
Deviation, deviation range, absolute value, or PV change rate alarm.



Setting

Refer to the alarm 1 type list. The 12: LBA (Loop Burnout Alarm) setting in that list cannot be used.



■ **Related Parameters**

Alarm value 3: Page 173, Alarm value upper limit 3, Alarm value lower limit 3: Page 175 (operation level)

Standby sequence reset: Page 221, Auxiliary output * open in alarm: Page 222, Alarm 3 hysteresis: Page 209, Alarm 3 latch: Page 227 (advanced function setting level)

LR-t

Transfer Output Type

There must be a transfer output or a current output.

- This parameter sets the transfer output type.
- The operation is shown in the following table.

■ **Transfer Output Destination**

Control output 1	Control output 2	Transfer output destination
Current output	<ul style="list-style-type: none"> • No • Relay output • Voltage output (for driving SSR) 	Control output 1
<ul style="list-style-type: none"> • Relay output • Voltage output (for driving SSR) 	<ul style="list-style-type: none"> • No • Relay output • Voltage output (for driving SSR) 	No

■ **Precision and User Calibration**

	Precision	User calibration
Transfer output	±0.3% FS	Supported (See note.)
Simple transfer output	±0.3% FS	Not supported.

Note Refer to *SECTION 6 CALIBRATION* for details on the calibration procedure.



Setting

Transfer output type		Default
OFF	\bar{OFF}	\bar{OFF}
Set point	SP	
Set point during SP ramp	$SP-M$	
PV	PV	
MV monitor (heating)	MV	
MV monitor (cooling)	$\bar{C-MV}$	

**■ Related Parameter**

Transfer output upper limit, Transfer output lower limit (initial setting level):
Page 212

LR-H Transfer Output Upper Limit

There must be a transfer output or a current output.

LR-L Transfer Output Lower Limit

The transfer output type must not be set to OFF.



- This parameter sets the upper and lower limit values of transfer outputs.



Transfer output type	Setting range		Default		Unit
			Transfer output lower limit	Transfer output upper limit	
Set point	SP lower limit to SP upper limit		SP lower limit	SP upper limit	EU
Set point during SP ramp	SP lower limit to SP upper limit				
PV	Temperature	Input setting range lower limit to input setting range upper limit	Input setting range lower limit	Input setting range upper limit	
	Analog	Analog scaling lower limit to analog scaling upper limit	Scaling lower limit	Scaling upper limit	
MV monitor (heating)	Standard	-5.0 to 105.0	0.0	100.0	%
	Heating/cooling	0.0 to 105.0			
MV monitor (cooling)	0.0 to 105.0				



■ **Related Parameter**

Transfer output type (initial setting level): Page 210

01-t Linear Current Output

Control output 1 must be a current output.

This parameter selects the output type for linear current outputs.



Linear current output	Default
4-20: 4 to 20 mA	4-20
0-20: 0 to 20 mA	

Note Even when control output 1 is used as a control output or a simple transfer output, 0 to 20 mA can be used.



■ **Related Parameter**

Transfer output type (initial setting level): Page 210

EV - M

Number of Multi-SP Uses

An event input must be assigned.



Function

- Multi-SP is a function for setting set points 0 to 3 in advance, and switching between these set points using a combination of event input ON/OFF signals.
- The Number of Multi-SP Uses parameter is used to switch between using two and four preset set points.



Setting

Setting range	Default
0 to 2	1

- Whether the Event Input Assignments 1 and 2 parameters are displayed or hidden is determined by the Number of Multi-SP Uses parameter setting.

Models with Two Event Inputs, 1 and 2

	Event input assignment 1	Event input assignment 2	Description of EV1 and EV2 operation
Number of multi-SP uses	0	Displayed (Multi-SP not used).	EV1 and EV2 will perform the operation command assigned using the Event Input Assignment 1 and 2 parameters.
	1	Not displayed (Operation performed with two Multi-SP points.)	Displayed (Event input 2 not used as multi-SP switch). EV1 will be used for the Multi-SP function to switch between set points 0 and 1. EV2 will perform the operation command assigned using the Event Input Assignment 2 parameter.
	2	Not displayed (Operation performed with four Multi-SP points.)	EV1 and EV2 will be used for the Multi-SP function to switch between set points 0, 1, 2, and 3.

The following tables show the relationships between ON/OFF combinations of event inputs 1 and 2 and selected set points.

Number of Multi-SP Uses: 1:

Even input 1	Selected set point
OFF	Set point 0
ON	Set point 1

Number of Multi-SP Uses: 2

Even input 1	Even input 2	Selected set point
OFF	OFF	Set point 0
ON	OFF	Set point 1
OFF	ON	Set point 2
ON	ON	Set point 3

Models with Two Event Inputs, 3 and 4

		Event input assignment 3	Event input assignment 4	Description of EV3 and EV4 operation
Number of multi-SP uses	0	Displayed (Multi-SP not used).		EV3 and EV4 will perform the operation command assigned using the Event Input Assignment 3 and 4 parameters.
	1	Not displayed (Operation performed with two Multi-SP points.)	Displayed (Event input 4 not used as multi-SP switch).	EV3 will be used for the Multi-SP function to switch between set points 0 and 1. EV4 will perform the operation command assigned using the Event Input Assignment 4 parameter.
	2	Not displayed (Operation performed with four Multi-SP points.)		EV3 and EV4 will be used for the Multi-SP function to switch between set points 0, 1, 2, and 3.

The following tables show the relationships between ON/OFF combinations of event inputs 3 and 4 and selected set points.

Number of Multi-SP Uses: 1:

Even input 3	Selected set point
OFF	Set point 0
ON	Set point 1

Number of Multi-SP Uses: 2:

Even input 3	Even input 4	Selected set point
OFF	OFF	Set point 0
ON	OFF	Set point 1
OFF	ON	Set point 2
ON	ON	Set point 3

Models with Four Event Inputs, 1 to 4

		Event input assignment 1	Event input assignment 2	Event input assignment 3	Event input assignment 4	Description of EV1, EV2, EV3, and EV4 operation
Number of Multi-SP Uses	0	Displayed (Multi-SP not used).				EV1, EV2, EV3, and EV4 will perform the operation command assigned using the Event Input Assignment 1, 2, 3, and 4 parameters.
	1	Not displayed (Operation performed with two Multi-SP points.)	Displayed (Event inputs 2, 3, and 4 cannot be used for multi-SP switching.)			EV1 will be used for the Multi-SP function to switch between set points 0 and 1. EV2, EV3, and EV4 will perform the operation command assigned using the Event Input Assignment 2, 3, and 4 parameters.
	2	Not displayed (Operation performed with four Multi-SP points.)	Displayed (Event inputs 3 and 4 cannot be used for multi-SP switching.)			EV1 and EV2 will be used for the Multi-SP function to switch between set points 0, 1, 2, and 3. EV3 and EV4 will perform the operation command assigned using the Event Input Assignment 3 and 4 parameters.

Only event inputs 1 and 2 are used for the multi-SP function.

The following tables show the relationships between ON/OFF combinations of event inputs 1 and 2 and selected set points.

Number of Multi-SP Uses: 1:

Even input 1	Selected set point
OFF	Set point 0
ON	Set point 1

Number of Multi-SP Uses: 2:

Even input 1	Even input 2	Selected set point
OFF	OFF	Set point 0
ON	OFF	Set point 1
OFF	ON	Set point 2
ON	ON	Set point 3

- The following table shows the functions assigned when an Event Input Assignment (1 or 2) is displayed.

Setting	Function
<i>NONE</i>	None
<i>StōP</i>	RUN/STOP
<i>MANU</i>	Auto/Manual Switch
<i>PRSt</i>	Program start (See note 1.)
<i>dRS</i>	Invert Direct/Reverse Operation
<i>RE - 2</i>	100% AT Execute/Cancel
<i>RE - 1</i>	40% AT Execute/Cancel (See note 2.)
<i>WTPT</i>	Setting Change Enable/Disable
<i>LRL</i>	Alarm Latch Cancel

- Note**
- (1) PRST (Program Start) can be set even when the Program Pattern parameter is set to OFF, but the function will be disabled.
 - (2) This function can be set for heating/cooling control, but the function will be disabled.
- When any of the following functions is set for an Event Input Assignment parameter, the same function cannot be set for another Event Input Assignment parameter: STOP (RUN/STOP), MANU (Auto/Manual Switch), PRST (Program Start), DRS (Invert Direct/Reverse Operation), AT-2 (100% AT Execute/Cancel), AT-1 (40% AT Execute/Cancel), WTPT (Setting Change Enable/Disable), or LAT (Alarm Latch Cancel).

- Note** Event inputs can be used on the E5CN-□M□ (with an E53-CN□B□N2) or E5AN/EN-□M□-N (with an E53-AKB) Controllers. Turn event inputs ON and OFF while the power is being supplied. Event input ON/OFF changes are detected for inputs of 50 ms or longer.

■ Related Parameter

SP0 to SP3 (adjustment level): Page 186

Event input assignment 1 and 2: Page 216 (initial setting level), Multi-SP use: Page 220 (advanced function setting level)



EV -*

Event Input Assignment * (*: 1 and 2)

An event input must be assigned.
Multi-SP must not be used.



Function

- The following functions can be assigned to event inputs 1 and 2.
 - RUN/STOP
 - Auto/Manual Switch
 - Program Start
 - Invert Direct/Reverse Operation
 - 100% AT Execute/Cancel
 - 40% AT Execute/Cancel
 - Setting Change Enable/Disable
 - Alarm Latch Cancel
- Default: Event Input Assignment 1: *NONE*
Event Input Assignment 2: *STOP*



Setting

Setting	Function
<i>NONE</i>	None
<i>STOP</i>	RUN/STOP
<i>MANU</i>	Auto/Manual
<i>PRST</i>	Program start (See note 1.)
<i>dRS</i>	Invert Direct/Reverse Operation
<i>RE - 2</i>	100% AT Execute/Cancel
<i>RE - 1</i>	40% AT Execute/Cancel (See note 2.)
<i>WEPE</i>	Setting Change Enable/Disable
<i>LAL</i>	Alarm Latch Cancel

- Note**
- (1) PRST (Program Start) can be set even when the Program Pattern parameter is set to OFF, but the function will be disabled.
 - (2) This function can be set for heating/cooling control, but the function will be disabled.

■ **Related Parameter**

- SP0 to SP3 (adjustment level): Page 186
- Number of multi-SP uses (initial setting level): Page 213



See

SQR

Extraction of Square Root Enable

An analog input must be supported.



Function

This parameter enables and disables square root extraction.



Setting

Setting range	Default
<i>ON</i> : Enabled, <i>OFF</i> : Disabled	OFF

**■ Related Parameter**



Extraction of square root low-cut point (adjustment level): Page 194

AMOV**Move to Advanced Function Setting Level**

The Initial Setting/Communications Protect parameter must be set to 0.



Function

- Set the Move to Advanced Function Setting Level parameter set value to “-169.”
- Move to the advanced function setting level either by pressing  Key or  Key or by waiting or two seconds to elapse.



**■ Related Parameter**

Initial setting/communication protect (protect level): Page 160

5-8 Advanced Function Setting Level

The advanced function setting level is used for optimizing Controller performance. To move to this level, input the password (“-169”) from the initial setting level.

To be able to enter the password, the Initial Setting/Communications Protect parameter in the protect level must be set to 0.

- The parameters in this level can be used when the Initial Setting/Communications Protect parameter is set to 0.
- To switch between setting levels, press the  Key.
- To change set values, press the  and  Keys.

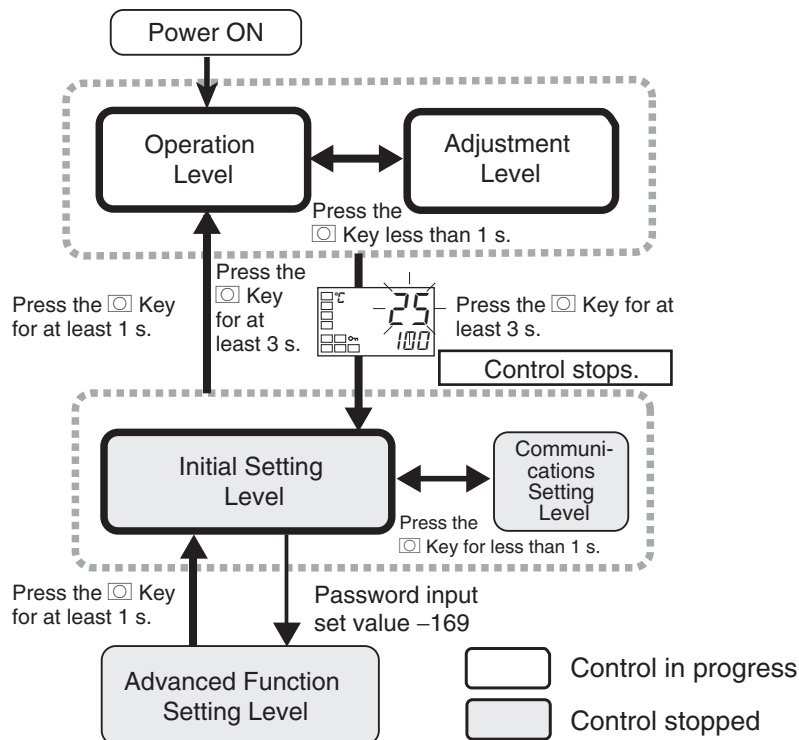

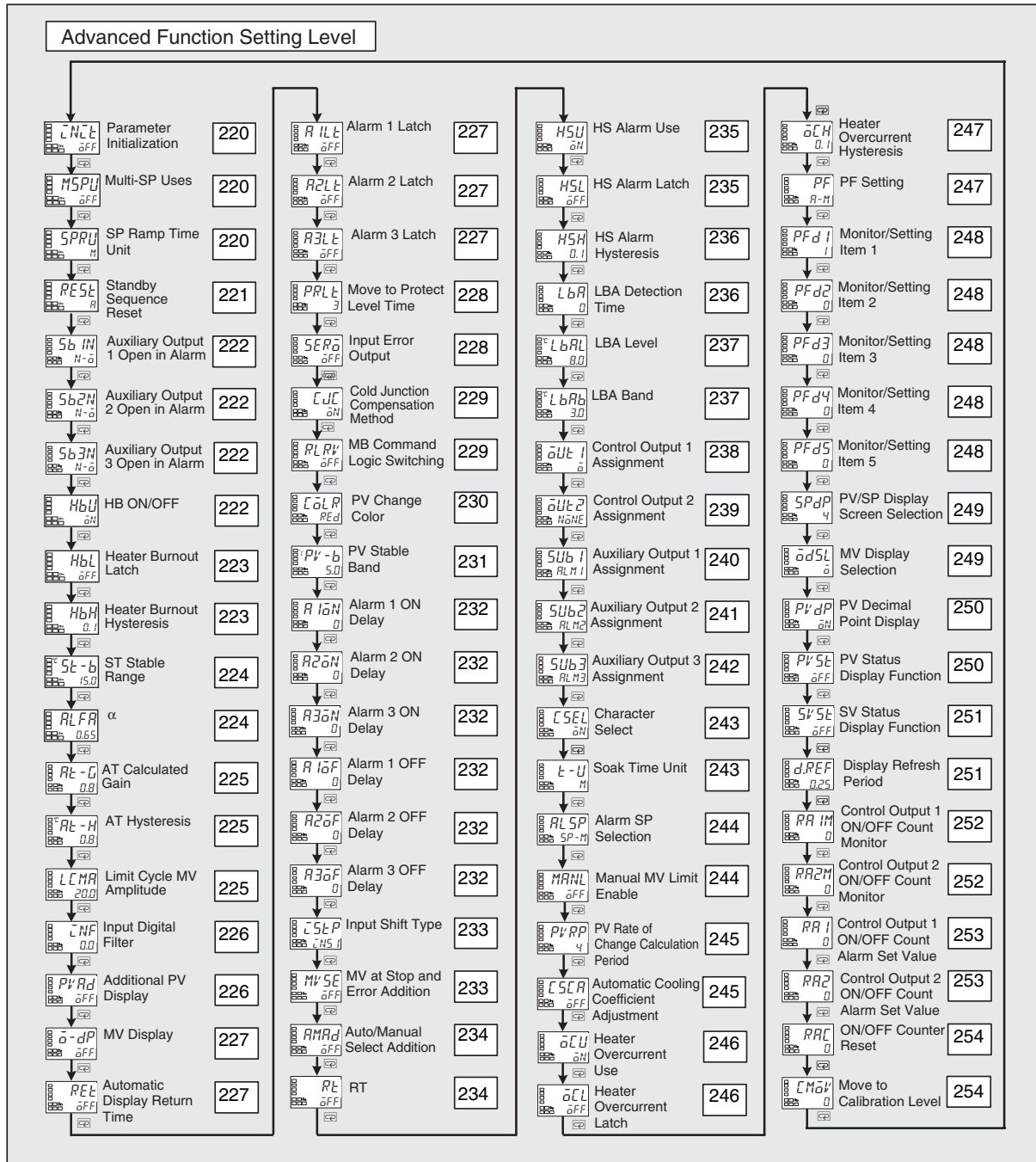

INLE

Parameter Initialization



Function

- This parameter returns all parameter settings to their defaults.
- After the initialization, the set value automatically turns \bar{OFF} .



Setting

Setting range	Default
\bar{OFF} : Initialization is not executed.	\bar{OFF}
$FALL$: Initializes to the factory settings described in the manual.	

MSPU

Multi-SP Uses

The model must not support event inputs, or the number of multi-SP uses must be 0.



Function

This parameter enables switching between set points 0 to 3 by operating the keys on the front panel.

Prerequisites

- A model without event inputs
- The Number of Multi-SP Uses parameter set to 0 on a model with event inputs

\bar{ON} : Set points 0 to 3 can be selected.

\bar{OFF} : Set points 0 to 3 cannot be selected.

- Default: OFF



Setting



■ **Related Parameters**

Multi-SP set point setting (operation level): Page 167

Number of multi-SP uses (Initial setting level): Page 213

SPRU

SP Ramp Time Unit

The ST parameter must be set to OFF.



Function

- This parameter sets the time unit for the rate of change during SP ramp operation.



Setting

Setting range	Default
S : EU/s, M : EU/min, H : EU/h	M



■ **Related Parameters**

Ramp SP monitor (operation level): Page 167

SP ramp set value (adjustment level): Page 193

RESL

Standby Sequence Reset

Alarm 1 to 3 type must be 5, 6, 7, 10, or 11.



- This parameter selects the conditions for enabling reset after the standby sequence of the alarm has been canceled.
- Output is turned OFF when switching to the initial setting level, communications setting level, advanced function setting level, or calibration level.
- Condition A
Control started (including power ON), and set point, alarm value (alarm value upper/lower limit), or input shift value (upper/lower-limit temperature input shift value) changed.
- Condition B
Power ON
- The following example shows the reset action when the alarm type is lower-limit alarm with standby sequence.

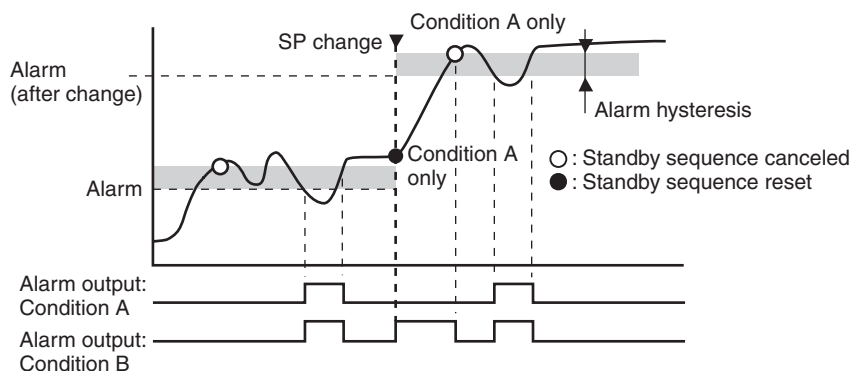

Setting range	Default
R: Condition A, b: Condition B	R



■ Related Parameters

Alarm 1 to 3 type (initial setting level): Page 207 to 209

Alarm 1 to 3 latch (advanced function setting level): Page 227

5b*N

Auxiliary Output * Open in Alarm
(*: 1 to 3)

Auxiliary output 1, 2, or 3 must be assigned.



- This parameter sets the output status of auxiliary outputs 1 to 3.
- When Close in Alarm is set, the status of the auxiliary output function is output unchanged. When Open in Alarm is set, the status of the auxiliary output function is reversed before being output. The following table shows the relationship between the auxiliary output function, auxiliary output, and operation displays (SUB1 to SUB3).



	Auxiliary output function	Auxiliary output	Operation display (SUB1 to SUB3)
Close in Alarm	ON	ON	Lit
	OFF	OFF	Not lit
Open in Alarm	ON	OFF	Lit
	OFF	ON	Not lit

Setting range	Default
$N-\bar{a}$: Close in alarm, $N-\bar{L}$: Open in alarm	$N-\bar{a}$



■ **Related Parameters**

Auxiliary output 1 to 3 assignment (advanced function setting level): Pages 240 to 242

HbU

HB ON/OFF

Heater burnout, HS alarms, and heater overcurrent detection must be supported.
Alarm 1 must be assigned.



- Set to use the heater burnout alarm.



Setting range	Default
$\bar{a}N$: Enabled, $\bar{a}FF$: Disabled	$\bar{a}N$

HbL

Heater Burnout Latch

Heater burnout, HS alarms, and heater overcurrent detection must be supported.
Alarm 1 must be assigned.
The Heater Burnout Detection parameter must be set to ON.



Function

- When this parameter is set to ON, the heater burnout alarm is held until either of the following conditions is satisfied.
 - a Heater burnout detection is set to 0.0 A.
 - b The power is cycled.
 - c The latch is cancelled by the PF Key.
(PF Setting = LAT: Alarm Latch Cancel)
 - d The latch is cancelled by an event input.
(Event Input Assignment 1 and 2 = LAT: Alarm Latch Cancel)
- Output is turned OFF when switching to the initial setting level, communications setting level, advanced function setting level, or calibration level.



Setting

Setting range	Default
$\bar{a}N$: Enabled, $\bar{a}FF$: Disabled	$\bar{a}FF$



See

■ **Related Parameters**

Event input assignment 1 and 2 (initial setting level): Page 216
HB ON/OFF: Page 222, PF setting: Page 247 (advanced function setting level)

HbH

Heater Burnout Hysteresis

The Heater Burnout parameter must be set to ON.
The Heater Burnout Latch parameter must be set to OFF.
Heater burnout, HS alarms, and heater overcurrent detection must be supported.
Alarm 1 must be assigned.



Function

- This parameter sets hysteresis for heater burnout detection.



Setting

Setting range	Unit	Default
0.1 to 50.0	A	0.1



See

■ **Related Parameters**

HB ON/OFF (advanced function setting level): Page 222

5t-b

ST Stable Range

ST must be ON and temperature input, standard control, 2-PID control must be set.



Function

- The setting of this parameter determines when ST operates. This parameter cannot be used when ST is set to OFF.



Setting

Setting range	Unit	Default
0.1 to 999.9	°C or °F	15.0

■ **Related Parameters**

Input type: Page 200, PID ON/OFF: Page 204, ST: Page 205 (initial setting level)



ALFA

α

ST must be OFF and 2-PID control must be set.



Function

- Normally, use the default for this parameter.
- This parameter sets the 2-PID control α constant.



Setting

Setting range	Unit	Default
0.00 to 1.00	None	0.65

■ **Related Parameters**

PID ON/OFF: Page 204, ST: Page 205 (initial setting level)



RE-G
RE-H
LCMA

AT Calculated Gain
AT Hysteresis
Limit Cycle MV Amplitude

Control must be set to 2-PID control.



Function

- Normally use the default values for these parameters.
- The AT Calculated Gain parameter sets the gain for when PID values are calculated using AT. When emphasizing response, decrease the set value. When emphasizing stability, increase the set value.
- The AT Hysteresis parameter sets the hysteresis for limit cycle operation during autotuning when switching ON and OFF.
- The Limit Cycle MV Amplitude parameter sets the MV amplitude for limit cycle operation during autotuning.



Setting

Parameter name	Setting range	Unit	Default
AT Calculated Gain	0.1 to 10.0	---	0.8
AT Hysteresis	Universal input: 0.1 to 999.9	°C or °F	0.8 (See note.)
	Analog input: 0.01 to 9.99	%FS	0.20
Limit Cycle MV Amplitude	5.0 to 50.0	%	20.0

Note When the temperature unit is °F, the default is 1.4.



See

■ **Related Parameters**

AT execute/cancel (adjustment level): Page 179

INF

Input Digital Filter



Function

- This parameter sets the time constant for the input digital filter. The following diagram shows the effect on data after passing through the digital filter:

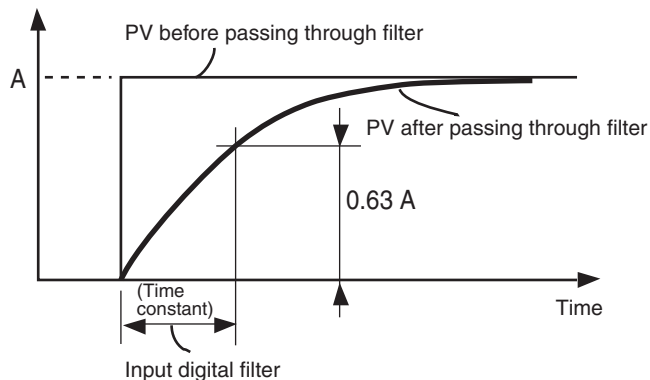

Setting range	Unit	Default
0.0 to 999.9	Second	0.0



Setting

PvAd

Additional PV Display



Function

This parameter adds a display at the beginning of the operation level for the process value (PV). If there is no need to display the set point, use this to display only the present temperature.

Set to ON to display, and OFF to not display.

Setting range	Default
$\bar{a}N$: Displayed, $\bar{a}FF$: Not displayed	$\bar{a}FF$



Setting

\bar{a} -dP

MV Display



This parameter is used to display the manipulated variable (MV).
 The manipulated variable is displayed when the MV Monitor (Heating) and MV Monitor (Cooling) parameters are set to ON, and not displayed when these parameters are set to OFF.



Setting range	Default
$\bar{a}N$: Displayed, $\bar{a}FF$: Not displayed	$\bar{a}FF$



■ **Related Parameters**

MV monitor (heating): Page 175, MV monitor (cooling): Page 176 (operation level)

REt

Automatic Display Return Time



- In the operation level, adjustment level, or monitor/setting item level, the display automatically returns to the PV/SP if there are no key operations for the time set for this parameter.
- The automatic display return time is disabled when the parameter is set to OFF. (In that case, the display will not be automatically switched.)



Setting range	Unit	Default
OFF, 1 to 99	Second	$\bar{a}FF$

R1Lt

Alarm 1 Latch

Alarm 1 must be assigned, and the alarm 1 type must not be 0.

R2Lt

Alarm 2 Latch

Alarm 2 must be assigned, and the alarm 2 type must not be 0 or 12.

R3Lt

Alarm 3 Latch

Alarm 3 must be assigned, and the alarm 3 type must not be 0 or 12.



- When this parameter is set to ON, the alarm function is held until one of the following conditions is satisfied.
 - The power is cycled.
 - The latch is cancelled by the PF Key. (PF Setting = LAT: Alarm Latch Cancel)
 - The latch is cancelled by an event input. (Event Input Assignment 1 and 2 = LAT: Alarm Latch Cancel)

- The output is turned OFF when switching to the initial setting level, communications setting level, advanced function setting level, or calibration level.
- If an auxiliary output is set to close in alarm, the output is kept closed. If it is set to open in alarm, it is kept open.



Setting range	Default
$\bar{a}N$: Enabled, $\bar{a}FF$: Disabled	$\bar{a}FF$



■ **Related Parameters**

Alarm value 1 to 3: Page 172 to 173, Alarm value upper limit 1 to 3: Page 174 to 175, Alarm value lower limit 1 to 3: Page 174 to 175 (operation level)
 Alarm 1 to 3 type (initial setting level): Page 207 to 210
 Standby sequence reset: Page 221, Auxiliary output 1 to 3 open in alarm: Page 222 (advanced function setting level), Alarm 1 to 3 hysteresis: Page 209 (initial setting level)
 Event input assignment 1 and 2 (initial setting level): Page 216
 HB ON/OFF: Page 222, PF setting: Page 247 (advanced function setting level)

PRLt

Move to Protect Level Time



- This parameter sets the key pressing time required to move to the protect level from the operation level, the adjustment level, or monitor/setting item level.



Setting range	Unit	Default
1 to 30	Second	3



■ **Related Parameters**

Operation/adjustment protect, Initial setting/communications protect, Setting change protect (protect level): Page 160

SEPa

Input Error Output

Alarm 1 must be assigned, but not to a work bit output.



- When this parameter is set to ON, the output assigned for alarm 1 turns ON for input errors.
Note For details on input errors, refer to *Error Displays* on page 281.
- The alarm 1 output is an OR output of alarm 1, HB alarm/HS alarm, heater overcurrent alarm, and input error.
- Output is turned OFF when switching to the initial setting level, communications setting level, advanced function setting level, or calibration level.



Setting range	Default
$\bar{0}N$: Enabled, $\bar{0}FF$: Disabled	$\bar{0}FF$

EJC

Cold Junction Compensation Method

Input type must be thermocouple or infrared temperature sensor



Function

- This parameter specifies whether cold junction compensation is to be performed internally by the Controller or to be performed externally when the input type setting is 5 to 22, 24, or 25.
- The cold junction compensation external setting is enabled when the temperature difference is measured using two thermocouples or two ES1B Sensors.



Setting

Setting range	Default
$\bar{0}N$: Internally, $\bar{0}FF$: Externally	$\bar{0}N$

■ **Related Parameters**

Input type (initial setting level): Page 200



See

RLRV

MB Command Logic Switching

Communications must be supported. CompoWay/F must be selected as the protocol.



Function

- This parameter switches the logic of the MB command (communications writing switch) for the SYSWAY communications protocol
- The MB command (communications writing switch) is the equivalent of the MB command (remote/local switch) of the E5□J.
- The setting indicated by the shaded cell indicates the default (same logic as E5□J).



Setting

Set value	Text data of MB command	
	0000	0001
OFF	Communications writing enabled (remote mode selection)	Communications writing disabled (local mode selection)
ON	Communications writing disabled (local mode selection)	Communications writing enabled (remote mode selection)

(Terms in parentheses () are the terms used on the E5□J.)

■ **Related Parameters**

Communications writing (adjustment level): Page 180

Protocol setting (communications setting level): Page 255



See

CoLR

PV Change Color



Function

Use the PV color change function to change the color of the PV display (No. 1 display).

There are three display colors, orange, red, and green, and you can select from the following three modes and eight types.

- Constant: This mode displays orange, red, or green all the time.
- Linked to Alarm 1: This mode switches the PV display color from red to green when alarm 1 turns ON or from green to red when alarm 1 turns ON.
- Linked to PV stable band: This mode switches the PV display color between red outside the PV stable band and green within PV stable band, or between green outside the PV stable band and red within PV stable band. Set the PV stable band in the PV Stable Band parameter in the advanced function setting level.
- The default is *REd* (red).

The following table shows the display functions that can be set using the PV color change function.



Setting

Mode	Setting	Function	PV change color		Application example
Constant	<i>ORg</i>	Orange	Constant: Orange		To match the display color with other Controller models
	<i>REd</i>	Red	Constant: Red		To match the display color with other Controller models
	<i>GRN</i>	Green	Constant: Green		To match the display color with other Controller models
Linked to alarm 1					
			ALM1 ON	ALM1 OFF	Application example
	<i>R-G</i>	Red to Green	Red	Green	To display the PV reached signal
	<i>G-R</i>	Green to Red	Green	Red	To display error signals

Mode	Setting	Function	PV change color			Application example
Linked to PV stable band						
			Low	PV stable band	High	Application example
	$R-\bar{L},R$	Red to Green to Red	Red	Green	Red	To display stable status
	$\bar{L}-\bar{a},R$	Green to Orange to Red	Green	Orange	Red	To display stable status
	$\bar{a}-\bar{L},R$	Orange to Green to Red	Orange	Green	Red	To display stable status

■ **Related Parameters**

PV stable band (advanced function setting level): Page 231



PV -b

PV Stable Band



This parameter sets the PV stable band width within which the PV display color is changed.

- When the mode to link to the PV stable band is selected with the PV Change Color parameter, the PV display color will change according to whether the present value (PV) is lower than, within, or higher than the PV stable band, as shown in the following figure.
- There is a hysteresis of 0.2 (°C or °F).

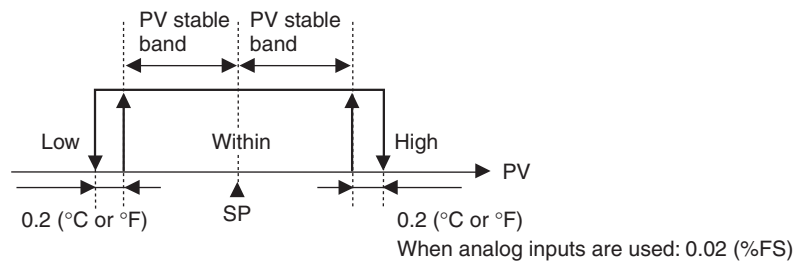

Models	Setting range	Unit	Default
Controllers with Thermocouple/Resistance Thermometer Universal Inputs	0.1 to 999.9	°C or °F (See note.)	5.0
Controllers with Analog Inputs	0.01 to 99.99	%FS	5.00

Note Set “None” as the unit for Controllers with Analog Inputs.

■ **Related Parameters**

PV change color (advanced function setting level): Page 230



R1 \bar{o} N

Alarm 1 ON Delay

Alarm 1 must be assigned, and the alarm 1 type must not be 0, 12, or 13.

R2 \bar{o} N

Alarm 2 ON Delay

Alarm 2 must be assigned, and the alarm 2 type must not be 0, 12, or 13.

R3 \bar{o} N

Alarm 3 ON Delay

Alarm 3 must be assigned, and the alarm 3 type must not be 0, 12, or 13.



Function



Setting

Alarm 1, 2, or 3 outputs are prevented from turning ON until after the delay times set in these parameters have elapsed.

- Set the time for which the ON delay is to be enabled.
- To disable the ON delay, set 0.

Setting range	Unit	Default
0 to 999	Second	0



■ **Related Parameters**

Alarm 1 to 3 type (initial setting level): Pages 207 to 210

R1 \bar{o} F

Alarm 1 OFF Delay

Alarm 1 must be assigned, and the alarm 1 type must not be 0, 12, or 13.

R2 \bar{o} F

Alarm 2 OFF Delay

Alarm 2 must be assigned, and the alarm 2 type must not be 0, 12, or 13.

R3 \bar{o} F

Alarm 3 OFF Delay

Alarm 3 must be assigned, and the alarm 3 type must not be 0, 12, or 13.



Function



Setting

Alarm 1, 2, or 3 outputs are prevented from turning OFF until after the delay times set in these parameters have elapsed.

- Set the time for which the OFF delay is to be enabled.
- To disable the OFF delay, set 0.

Setting range	Unit	Default
0 to 999	Second	0



■ **Related Parameters**

Alarm 1 to 3 type (initial setting level): Pages 207 to 210

↳5LP

Input Shift Type

The input type must be thermocouple or resistance thermometer.

This parameter sets the shift method for thermocouple or resistance thermometer inputs.

- When the input type is thermocouple or resistance thermometer, set either a 1-point shift or a 2-point shift.



Function



Setting

Setting range	Default
↳NS1: 1-point shift, ↳NS2: 2-point shift	↳NS1

■ **Related Parameters**

Temperature input shift, Upper-limit temperature input shift value, Lower-limit temperature input shift value (adjustment level): Page 186

Input type (initial setting level): Page 200



↳VSE

MV at Stop and Error Addition

The control must be set to 2-PID control.

This parameter sets whether or not the MV at Stop and MV at PV Error parameters are to be displayed.

- Set whether or not the MV at Stop and MV at PV Error parameters are to be displayed.



Function



Setting

Setting range	Default
↳N: Displayed, ↳FF: Not displayed	↳FF

■ **Related Parameters**

MV at stop, MV at PV error (adjustment level): Page 192



RMRd**Auto/Manual Select Addition**

The control must be set to 2-PID control.



Function



Setting

This parameter sets whether the Auto/Manual Switch parameter is to be displayed.

- Set whether the Auto/Manual Switch parameter is to be displayed.

Setting range	Default
$\bar{a}N$: Displayed, $\bar{a}FF$: Not displayed	$\bar{a}FF$



■ **Related Parameters**

Auto/manual switch (operation level): Page 166

RL**RT**

The control must be set to 2-PID control.
The input type must be set to temperature input.



Function



Setting

This parameter executes robust tuning (RT).

- When AT or ST is executed with RT selected, PID constants are automatically set which make it hard for control performance to degenerate even when control object characteristics are changed.
- Even when hunting occurs for PID constants when AT or ST is executed in normal mode, it is less likely to occur when AT or ST is executed in RT mode.

Setting range	Default
$\bar{a}N$: RT function OFF, $\bar{a}FF$: RT function ON	$\bar{a}FF$



■ **Related Parameters**

AT execute/cancel: Page 179, Proportional band, Integral time, Derivative time: Page 188 (adjustment level)

PID ON/OFF: Page 204, ST: Page 205 (initial setting level)

H5U

HS Alarm Use

Heater burnout, HS alarms, and heater overcurrent detection must be supported.
Alarm 1 must be assigned.



Function

- Set this parameter to use HS alarms.



Setting

Setting range	Default
$\bar{0}N$: Enabled, $\bar{0}FF$: Disabled	$\bar{0}N$

H5L

HS Alarm Latch

Heater burnout, HS alarms, and heater overcurrent detection must be supported.
Alarm 1 must be assigned.
The HS Alarm parameter must be set to ON.



Function

- When this parameter is set to ON, the HS alarm is held until any of the following conditions is satisfied.
 - The HS alarm current is set to 50.0 A.
 - The power is cycled.
 - The latch is cancelled by the PF Key.
(PF Setting = LAT: Alarm Latch Cancel)
 - The latch is cancelled by an event input.
(Event Input Assignment 1 and 2 = LAT: Alarm Latch Cancel)
- Output is turned OFF when switching to the initial setting level, communications setting level, advanced function setting level, or calibration level.



Setting

Setting range	Default
$\bar{0}N$: Enabled, $\bar{0}FF$: Disabled	OFF



See

■ **Related Parameters**

- HS alarm use (advanced function setting level): Page 235
- Event input assignment 1 and 2 (initial setting level): Page 216
- HB ON/OFF: Page 222, PF setting: Page 247 (advanced function setting level)

HS

HS Alarm Hysteresis

Heater burnout and HS alarms must be supported.
 Alarm 1 must be assigned.
 The HS Alarm parameter must be set to ON.
 The HS Alarm Latch parameter must be set to OFF.



Function

- This parameter sets the hysteresis for HS alarms.



Setting

Setting range	Unit	Default
0.1 to 50.0	A	0.1

■ **Related Parameters**

HS alarm use (advanced function setting level): Page 235



See

LbA

LBA Detection Time

Alarm 1 must be assigned.
 The alarm type must be set to 12 (LBA).



Function

This parameter enables or disables the LBA function and sets the detection time interval.

- Set the time interval for detecting loop burnouts.
- To disable the LBA function, set 0.



Setting

Setting range	Unit	Default
0 to 9999	Second	0

■ **Related Parameters**

Alarm 1 type (initial setting level): Page 207

LBA level: Page 237, LBA band: Page 237 (advanced function setting level)



See

LbAL

LBA Level

Alarm 1 must be assigned.
The alarm type must be set to 12 (LBA).
The LBA detection time must not be 0.



Function

- This parameter sets the LBA level.
- If the deviation between the SP and PV exceeds the LBA level, a loop burnout is detected.



Setting

Models	Setting range	Unit	Default
Controllers with Thermocouple/Resistance Thermometer Universal Inputs	0.1 to 999.9	°C or °F (See note.)	8.0
Controllers with Analog Inputs	0.01 to 99.99	%FS	10.00

Note Set “None” as the unit for Controllers with Analog Inputs.



■ **Related Parameters**

Process value/set point (operation level): Page 165

Alarm 1 type (initial setting level): Page 207

LBA detection time: Page 236, LBA band: Page 237 (advanced function setting level)

LbAb

LBA Band

Alarm 1 must be assigned.
The alarm type must be set to 12 (LBA).
The LBA detection time must not be 0.



Function

- This parameter sets the LBA band.
- If a control deviation greater than the LBA band is not reduced when the LBA level is exceeded, an loop burnout is detected.



Setting

Models	Setting range	Unit	Default
Controllers with Thermocouple/Resistance Thermometer Universal Inputs	0.0 to 999.9	°C or °F (See note.)	3.0
Controllers with Analog Inputs	0.00 to 99.99	%FS	0.20

Note Set “None” as the unit for Controllers with Analog Inputs.



■ **Related Parameters**

Process value/set point (operation level): Page 165

Alarm 1 type (initial setting level): Page 207

LBA detection time, LBA level (advanced function setting level): Page 236

āūē 1

Control Output 1 Assignment

The transfer output type must be set to OFF when the control output is a current output.



Function



Setting

- This parameter sets the function to be assigned to control output 1.

Setting range	Default
<i>nāNE</i> : No function is assigned to control output 1.	<i>ā</i>
<i>ā</i> : Heating control output is output.	
<i>ē - ā</i> : Cooling control output is output. (See note 1.)	
<i>RLM1</i> : Alarm 1 is output. (See note 2.)	
<i>RLM2</i> : Alarm 2 is output. (See note 2.)	
<i>RLM3</i> : Alarm 3 is output. (See note 2.)	
<i>P.ENd</i> : Program end is output. (See notes 2 and 3.)	
<i>RRLM</i> : Control output ON/OFF count alarm (See note 2.)	
<i>WR1</i> : Work bit 1 (See notes 2 and 4.)	
<i>WR2</i> : Work bit 2 (See notes 2 and 4.)	
<i>WR3</i> : Work bit 3 (See notes 2 and 4.)	
<i>WR4</i> : Work bit 4 (See notes 2 and 4.)	
<i>WR5</i> : Work bit 5 (See notes 2 and 4.)	
<i>WR6</i> : Work bit 6 (See notes 2 and 4.)	
<i>WR7</i> : Work bit 7 (See notes 2 and 4.)	
<i>WR8</i> : Work bit 8 (See notes 2 and 4.)	

- Note**
- (1) If *ē - ā* is assigned for standard control, a value equivalent to 0% is output.
 - (2) Can be selected for relay and voltage outputs (for driving SSR) only.
 - (3) Can be selected when the Program Pattern parameter is set to OFF, but the function will be disabled.
 - (4) WR1 to WR8 are not displayed when the logic operation function is not used.

■ **Related Parameters**

Standard or heating/cooling: Page 204, Program pattern: Page 205, Transfer output type: Page 210 (initial setting level)





Control Output 2 Assignment

Control output 2 must be assigned.



Function



Setting

- This parameter sets the function to be assigned to control output 2.

Setting range	Default
<i>NONE</i> : No function is assigned to control output 2.	<i>NONE</i> (See note 3.)
<i>h</i> : Heating control output is output.	
<i>c-h</i> : Cooling control output is output. (See note 1.)	
<i>ALM1</i> : Alarm 1 is output.	
<i>ALM2</i> : Alarm 2 is output.	
<i>ALM3</i> : Alarm 3 is output.	
<i>PEND</i> : Program end is output. (See note 2.)	
<i>RRM</i> : Control output ON/OFF count alarm	
<i>WR1</i> : Work bit 1 (See note 4.)	
<i>WR2</i> : Work bit 2 (See note 4.)	
<i>WR3</i> : Work bit 3 (See note 4.)	
<i>WR4</i> : Work bit 4 (See note 4.)	
<i>WR5</i> : Work bit 5 (See note 4.)	
<i>WR6</i> : Work bit 6 (See note 4.)	
<i>WR7</i> : Work bit 7 (See note 4.)	
<i>WR8</i> : Work bit 8 (See note 4.)	

- Note**
- (1) If *c-h* is assigned for standard control, a value equivalent to 0% will be output.
 - (2) Can be selected when the Program Pattern parameter is set to OFF, but the function will be disabled.
 - (3) If the Standard or Heating/Cooling parameter is set to heating/cooling control, control automatically switches to *c-h*.
 - (4) WR1 to WR8 are not displayed when the logic operation function is not used.

■ **Related Parameters**

Standard or heating/cooling: Page 204, Program pattern: Page 205, (initial setting level)



Sub 1

Auxiliary Output 1 Assignment

Auxiliary output 1 must be assigned.



Function



Setting

- This parameter sets the function to be assigned to auxiliary output 1.

Setting range	Default
<i>NONE</i> : No function is assigned to auxiliary output 1.	<i>RLM 1</i> (See note 3.) (See note 5.)
\bar{a} : Heating control output is output.	
$\bar{c} - \bar{a}$: Cooling control output is output. (See note 1.)	
<i>RLM 1</i> : Alarm 1 is output.	
<i>RLM 2</i> : Alarm 2 is output.	
<i>RLM 3</i> : Alarm 3 is output.	
<i>P.END</i> : Program end is output. (See note 2.)	
<i>RRLM</i> : Control output ON/OFF count alarm	
<i>WR 1</i> : Work bit 1 (See note 4.)	
<i>WR 2</i> : Work bit 2 (See note 4.)	
<i>WR 3</i> : Work bit 3 (See note 4.)	
<i>WR 4</i> : Work bit 4 (See note 4.)	
<i>WR 5</i> : Work bit 5 (See note 4.)	
<i>WR 6</i> : Work bit 6 (See note 4.)	
<i>WR 7</i> : Work bit 7 (See note 4.)	
<i>WR 8</i> : Work bit 8 (See note 4.)	

- Note**
- (1) If $\bar{c} - \bar{a}$ is assigned for standard control, a value equivalent to 0% will be output.
 - (2) Can be selected when the Program Pattern parameter is set to OFF, but the function will be disabled.
 - (3) If a setting is changed when the Program Pattern parameter is not set to OFF, control automatically switches to *P.END*.
 - (4) WR1 to WR8 are not displayed when the logic operation function is not used.
 - (5) If the Standard or Heating/Cooling parameter is set to heating/cooling control, this parameter will automatically be set to $\bar{c} - \bar{a}$.

■ **Related Parameters**

Program pattern (initial setting level): Page 205

See

Sub 2

Auxiliary Output 2 Assignment

Auxiliary output 2 must be assigned.



Function

- This parameter sets the function to be assigned to auxiliary output 2.

Setting range	Default
<i>NONE</i> : No function is assigned to auxiliary output 2.	<i>RLM2</i> (See note 3.)
\bar{a} : Heating control output is output.	
$\bar{c} - \bar{a}$: Cooling control output is output. (See note 1.)	
<i>RLM1</i> : Alarm 1 is output.	
<i>RLM2</i> : Alarm 2 is output.	
<i>RLM3</i> : Alarm 3 is output.	
<i>P. END</i> : Program end is output. (See note 2.)	
<i>RRLM</i> : Control output ON/OFF count alarm	
<i>WR1</i> : Work bit 1 (See note 4.)	
<i>WR2</i> : Work bit 2 (See note 4.)	
<i>WR3</i> : Work bit 3 (See note 4.)	
<i>WR4</i> : Work bit 4 (See note 4.)	
<i>WR5</i> : Work bit 5 (See note 4.)	
<i>WR6</i> : Work bit 6 (See note 4.)	
<i>WR7</i> : Work bit 7 (See note 4.)	
<i>WR8</i> : Work bit 8 (See note 4.)	

- Note**
- (1) If $\bar{c} - \bar{a}$ is assigned for standard control, a value equivalent to 0% will be output.
 - (2) Can be selected when the Program Pattern parameter is set to OFF, but the function will be disabled.
 - (3) If the Standard or Heating/Cooling parameter is set to heating/cooling control when there is no control output 2 (E5CN/CN-U), control automatically switches to $\bar{c} - \bar{a}$.
 - (4) WR1 to WR8 are not displayed when the logic operation function is not used.

■ **Related Parameters**

Standard or heating/cooling: Page 204, Program pattern: Page 205, (initial setting level)



Sub3

Auxiliary Output 3 Assignment

Auxiliary output 3 must be assigned (E5AN and E5EN only).



- This parameter sets the function to be assigned to Auxiliary output 3.

Setting range	Default
<i>NONE</i> : No function is assigned to auxiliary output 3.	<i>RLM3</i> (See note 3.)
<i>ā</i> : Heating control output is output.	
<i>Ē - ā</i> : Cooling control output is output. (See note 1.)	
<i>RLM1</i> : Alarm 1 is output.	
<i>RLM2</i> : Alarm 2 is output.	
<i>RLM3</i> : Alarm 3 is output.	
<i>P.ENd</i> : Program end is output. (See note 2.)	
<i>PRLM</i> : Control output ON/Off count alarm	
<i>WR1</i> : Work bit 1 (See note 4.)	
<i>WR2</i> : Work bit 2 (See note 4.)	
<i>WR3</i> : Work bit 3 (See note 4.)	
<i>WR4</i> : Work bit 4 (See note 4.)	
<i>WR5</i> : Work bit 5 (See note 4.)	
<i>WR6</i> : Work bit 6 (See note 4.)	
<i>WR7</i> : Work bit 7 (See note 4.)	
<i>WR8</i> : Work bit 8 (See note 4.)	

- Note**
- (1) If *Ē - ā* is assigned for standard control, a value equivalent to 0% will be output.
 - (2) Can be selected when the Program Pattern parameter is set to OFF, but the function will be disabled.
 - (3) If the Standard or Heating/Cooling parameter is set to heating/cooling control when there is no control output 2 (E5AN/EN), control automatically switches to *Ē - ā*.
 - (4) WR1 to WR8 are not displayed when the logic operation function is not used.



■ **Related Parameters**

Standard or heating/cooling: Page 204, Program pattern: Page 205, (initial setting level)

ESEL

Character Select



Function

- This parameter switches the characters to be displayed. The following two types of characters can be displayed.
11-segment display
7-segment display



Setting

Setting range	Default
$\bar{a}N$: 11-segment display, $\bar{a}FF$: 7-segment display	$\bar{a}N$

When set to $\bar{a}N$, an 11-segment display is used.

E-U

Soak Time Unit

The Program Pattern parameter must not be set to OFF.



Function

- Set the soak time unit for the simple program function.



Setting

Setting range	Default
M: Minutes, H: Hours	M



See

■ **Related Parameters**

- Program start, Soak time remain (operation level): Page 171
- Soak time, Wait band (adjustment level): Page 191
- Program pattern (initial setting level): Page 205

RLSP

Alarm SP Selection

Alarm 1, 2, and 3 functions must be assigned.
 The SP Ramp Set Value parameter must not be set to OFF.
 The ST parameter must be set to OFF.
 The alarm type must be set to 1, 2, 3, 4, 5, 6, or 7.



Function

This parameter sets whether the set point that triggers a deviation alarm during SP ramp operation is to be the ramp SP or target SP.

- Set whether the set point that triggers a deviation alarm is the ramp SP or target SP.



Setting

Setting range	Default
SP-M: Ramp SP, SP: SP	SP-M



See

■ **Related Parameters**

SP ramp set value (adjustment level): Page 193
 ST (initial setting level): Page 205

MRNL

Manual MV Limit Enable

The control must be set to 2-PID control.



Function

This parameter sets whether the MV Upper Limit and MV Lower Limit parameters are to be enabled for manual MV in manual mode.



Setting

Setting range	Default
ON: Enabled, OFF: Disabled	OFF



See

■ **Related Parameters**

MV upper limit, MV lower limit (adjustment level): Page 193

PV RP

PV Rate of Change Calculation Period

Alarms 1, 2, and 3 must be assigned. The alarm type must be set to 13.



- The change width can be found for PV input values in any set period. Differences with previous values in each set period are calculated, and an alarm is output if the results exceed the alarm value.
- The PV rate of change calculation period can be set in units of 250 ms (sampling period).



Setting range	Unit	Default
1 to 999	Sampling period	4 (1 s)



■ **Related Parameters**

Present value, Process value/set point (operation level): Page 165
 Alarm 1 to 3 type, (Initial setting level): Pages 207 to 210

ESCA

Automatic Cooling Coefficient Adjustment

The control must be set to heating/cooling control and 2-PID control.



- By setting the Automatic Cooling Coefficient Adjustment parameter to ON, autotuning can be executed during heating/cooling control to automatically calculate the cooling coefficient at the same time as the PID parameters. If there is strong non-linear gain for the cooling characteristics, such as when cooling water boils for cooling control, it may not be possible to obtain the optimum cooling coefficient at the Controller, and control may take the form of oscillating waves. If that occurs, increase the proportional band or the cooling coefficient to improve control.



Setting range	Default
ON: Enabled, OFF: Disabled	OFF



■ **Related Parameters**

Cooling coefficient (adjustment level): Page 189

$\bar{a}CU$

Heater Overcurrent Use

Heater burnout, HS alarms, and heater overcurrent detection must be supported.
Alarm 1 must be assigned.



Function

- Set this parameter to use the heater overcurrent alarm.



Setting

Setting range	Default
$\bar{a}N$: Enabled, $\bar{a}FF$: Disabled	ON

$\bar{a}CL$

Heater Overcurrent Latch

Heater burnout, HS alarms, and heater overcurrent detection must be supported (two CTs).
Alarm 1 must be assigned.



Function

- When this parameter is set to ON, the heater overcurrent alarm is held until any of the following conditions is satisfied.
 - Heater overcurrent detection is set to 50.0 A.
 - The power is cycled.
 - The latch is cancelled by the PF Key.
(PF Setting = LAT: Alarm Latch Cancel)
 - The latch is cancelled by an event input.
(Event Input Assignment 1 and 2 = LAT: Alarm Latch Cancel)
- Output is turned OFF when switching to the initial setting level, communications setting level, advanced function setting level, or calibration level.



Setting

Setting range	Default
$\bar{a}N$: Enabled, $\bar{a}FF$: Disabled	OFF



See

■ **Related Parameters**

- Heater overcurrent detection 1, Heater overcurrent detection 2 (adjustment level): Pages 181, and 183
- Heater overcurrent use (advanced function setting level): Page 246
- Heater overcurrent hysteresis (advanced function setting level): Page 247
- Event input assignment 1 and 2 (initial setting level): Page 216
- HB ON/OFF: Page 222, PF setting: Page 247 (advanced function setting level)

$\bar{a}CH$

Heater Overcurrent Hysteresis

Heater burnout, HS alarms, and heater overcurrent detection must be supported, and alarm 1 must be assigned. The Heater Overcurrent Use parameter must be set to ON, and the Heater Overcurrent Latch parameter must be set to OFF.



Function

- This parameter sets the hysteresis for heater overcurrent detection.



Setting

Setting range	Unit	Default
0.1 to 50.0	A	0.1

■ Related Parameters

Heater overcurrent use (advanced function setting level): Page 246



See

PF

PF Setting

The PF Key must be supported (E5AN/EN).



Function

- This parameter sets the function of the PF Key.

- The default is A-M.



Setting

Set value	Setting	Function
OFF: $\bar{a}FF$	Disabled	Does not operate as a function key.
RUN: RUN	RUN	Specifies RUN status.
STOP: $St\bar{a}P$	STOP	Specifies STOP status.
R-S: $R-S$	Reversing RUN/STOP operation	Specifies reversing RUN/STOP operation status.
AT-2: $Rt-2$	100%AT Execute/Cancel	Specifies reversing 100% AT Execute/Cancel status. (See note 1.)
AT-1: $Rt-1$	40%AT Execute/Cancel	Specifies reversing 40% AT Execute/Cancel status. (See note 1.)
LAT: LRL	Alarm Latch Cancel	Specifies canceling alarm latches. (See note 2.)
A-M: $R-M$	Auto/Manual	Specifies reversing Auto/Manual status (See note 3.)
PFDP: $PFdP$	Monitor/Setting Item	Specifies the monitor/setting item display. Select the monitor/setting item using the Monitor/Setting Item 1 to 5 parameters (advanced function setting level).

Note

(1) When AT cancel is specified, it means that AT is cancelled regardless of whether the AT currently being executed is 100% AT or 40% AT.

- (2) Alarms 1 to 3, heater burnout, HS alarms, and heater overcurrent latches are cancelled.
- (3) For details on auto/manual operations using the PF Key, refer to 4-13 Performing Manual Control.



■ **Related Parameters**

Monitor/setting item 1 to 5 (advanced function setting level): Page 248

PFd*

Monitor/Setting Item * (*: 1 to 5)

The PF Setting parameter must be set to PFDP.



- Set the PF Key parameter to Monitor/Setting Item to enable using the function key to display monitor/setting items. The items that will be displayed are set using the Monitor/Setting Item 1 to 5 parameters. The settings are listed in the following table.



Set value	Setting	Remarks	
		Monitor/Setting	Symbol
0	Disabled		---
1	PV/SP/Multi-SP	Can be set. (SP)	---
2	PV/SP/MV (See note.)	Can be set. (SP)	---
3	PV/SP/Soak time remain	Can be set. (SP)	---
4	Proportional band (P)	Can be set.	P
5	Integral time (I)	Can be set.	I
6	Derivative time (D)	Can be set.	d
7	Alarm value 1	Can be set.	AL - 1
8	Alarm value upper limit 1	Can be set.	AL 1H
9	Alarm value lower limit 1	Can be set.	AL 1L
10	Alarm value 2	Can be set.	AL - 2
11	Alarm value upper limit 2	Can be set.	AL 2H
12	Alarm value lower limit 2	Can be set.	AL 2L
13	Alarm value 3	Can be set.	AL - 3
14	Alarm value upper limit 3	Can be set.	AL 3H
15	Alarm value lower limit 3	Can be set.	AL 3L

Note The MV for heating and cooling control is set in the MV Display Selection parameter.



■ **Related Parameters**

PF setting: Page 247, MV display selection: Page 249 (advanced function setting level)

SPdP

PV/SP Display Screen Selection

The No. 3 display must be supported (E5AN/EN).



- This parameter sets the PV/SP Screen No. 3 display and order of display.
- The default is 4.*
 - * A 2-level display is set at the time of shipping from the factory. (set value: 0)
 - A 3-level display is activated if parameters are initialized. (set value: 4)



Set value	Display contents
0	Only PV/SP is displayed (with no No. 3 display).
1	PV/SP/Multi-SP and PV/SP/MV are displayed in order. (See note.)
2	PV/SP/MV and PV/SP/Multi-SP are displayed in order. (See note.)
3	Only PV/SP/Multi-SP is displayed.
4	PV/SP/MV is displayed (See note.)
5	PV/SP/Multi-SP and PV/SP/Soak time remain are displayed in order. (See note.)
6	PV/SP/MV and PV/SP/Soak time remain are displayed in order. (See note.)
7	Only PV/SP/Soak time remain is displayed.

Note The MV for heating and cooling control is set in the MV Display Selection parameter.



■ **Related Parameters**

Process value/set point (operation level): Page 165

MV display selection (advanced function setting level): Page 249

ōd5L

MV Display Selection

The No. 3 display must be supported (E5AN/EN).

Heating and cooling control must be used.

The PV/SP Display Screen Selection parameter must be set to 1, 2, 4, or 6, or the Monitor/Setting Item 1 to 5 parameter must be set to 2.



- This parameter selects the MV display for PV/SP/MV during heating and cooling control. Either heating MV or cooling MV can be selected.



Setting range	Default
ō: MV (heating)	ō
[-ō: MV (cooling)	

PV dP

PV Decimal Point Display

The input type must be set to temperature input.



Function

The display below the decimal point in the PV can be hidden for temperature inputs.

- The PV decimals below the decimal point can be hidden by setting the PV Decimal Point Display parameter to OFF. When this parameter is set to ON, the display below the decimal point will appear according to the input type setting.



Setting

Setting range	Default
$\bar{o}N$: ON, $\bar{o}FF$: OFF	ON



■ **Related Parameters**

Input type (initial setting level): Page 200

PV St

PV Status Display Function



Function

- The PV in the No. 1 display for the PV/SP, PV, or PV/Manual MV Screen is alternately displayed in 0.5-s cycles with the control and alarm status specified for the PV status display function.



Monitor

Monitor range	Default
$\bar{o}FF$: No PV status display	$\bar{o}FF$
$M\bar{A}N\bar{U}$: MANU is alternately displayed during manual control.	
$S\bar{T}O\bar{P}$: STOP is alternately displayed while operation is stopped.	
$ALM1$: ALM1 is alternately displayed during Alarm 1 status.	
$ALM2$: ALM2 is alternately displayed during Alarm 2 status.	
$ALM3$: ALM3 is alternately displayed during Alarm 3 status.	
ALM : ALM is alternately displayed when Alarm 1, 2, or 3 is set to ON.	
$H\bar{A}$: HA is alternately displayed when a heater burnout alarm, HS alarm, or heater overcurrent alarm is ON.	



■ **Related Parameters**

Process value/set point, PV (operation level): Page 165

PV/MV (manual MV) (manual control level): Page 197

SVSt SV Status Display Function



Function

- The SP, Blank, or Manual MV in the No. 2 display for the PV/SP, PV, or PV/Manual MV Screen is alternately displayed in 0.5-s cycles with the control and alarm status specified for the SV status display function.



Monitor

Monitor range	Default
<i>OFF</i> : No SV status display	<i>OFF</i>
<i>MANU</i> : MANU is alternately displayed during manual control.	
<i>StOP</i> : STOP is alternately displayed while operation is stopped.	
<i>ALM1</i> : ALM1 is alternately displayed during Alarm 1 status.	
<i>ALM2</i> : ALM2 is alternately displayed during Alarm 2 status.	
<i>ALM3</i> : ALM3 is alternately displayed during Alarm 3 status.	
<i>ALM</i> : ALM is alternately displayed when Alarm 1, 2, or 3 is set to ON.	
<i>HA</i> : HA is alternately displayed when a heater burnout alarm, HS alarm, or heater overcurrent alarm is ON.	



■ **Related Parameters**

- Process value/set point, PV (operation level): Page 165
- PV/MV (manual MV) (manual control level): Page 197

d.REF Display Refresh Period



Function

- This parameter delays the display refresh period for monitor values. Only display refreshing is delayed, and the refresh period for process values used in control is not changed.
- This function is disabled by setting the parameter to OFF.



Monitor

Setting range	Unit	Default
OFF, 0.25, 0.5, 1.0	Second	0.25

RR1M

Control Output 1 ON/OFF Count Monitor

Control output 1 must be supported.
Relay or voltage outputs (for driving SSR) must be used.
The Control Output 1 ON/OFF Count Alarm Set Value parameter must not be set to 0.



Function

- This parameter monitors the number of times that control output 1 is turned ON and OFF.
- This function is not displayed when the set value is 0, or when the control output is a linear output.



Monitor

Monitor range	Unit
0 to 9999	100 times

RR2M

Control Output 2 ON/OFF Count Monitor

Control output 2 must be supported.
Relay or voltage outputs (for driving SSR) must be used.
The Control Output 2 ON/OFF Count Alarm Set Value parameter must not be set to 0.



Function

- This parameter monitors the number of times that control output 2 is turned ON and OFF.
- This function is not displayed when the set value is 0, or when the control output is a linear output.



Monitor

Monitor range	Unit
0 to 9999	100 times

RR1

Control Output 1 ON/OFF Count Alarm Set Value

Control output 1 must be supported. Relay or voltage outputs (for driving SSR) must be used.



Function

- An ON/OFF count alarm occurs when the ON/OFF counter exceeds the value set for this parameter.
- It is possible to assign ON/OFF count alarms to auxiliary outputs and to have them displayed on the screen.
- This function is disabled when the set value is 0.



Monitor

Setting range	Unit	Default
0 to 9999	100 times	0



■ **Related Parameters**

Control output 1 ON/OFF count monitor (advanced function setting level):
Page 252

RR2

Control Output 2 ON/OFF Count Alarm Set Value

Control output 2 must be supported. Relay or voltage outputs (for driving SSR) must be used.



Function

- An ON/OFF count alarm occurs when the ON/OFF counter exceeds the value set for this parameter.
- It is possible to assign ON/OFF count alarms to auxiliary outputs and to have them displayed on the screen.
- This function is disabled when the set value is 0.



Monitor

Setting range	Unit	Default
0 to 9999	100 times	0



■ **Related Parameters**

Control output 2 ON/OFF count monitor (advanced function setting level):
Page 252

RAC

ON/OFF Counter Reset

Control outputs 1 and 2 must be supported.
Relay or voltage outputs (for driving SSR) must be used.



Function

- This parameter resets the ON/OFF counter for specified control outputs.



Setting

Setting range	Default
0: Disable the counter reset function.	0
1: Reset the control output 1 ON/OFF counter.	
2: Reset the control output 2 ON/OFF counter.	

Note After the counter has been reset, the set value will be automatically returned to 0.



■ **Related Parameters**

Control output 1 ON/OFF count monitor, Control output 2 ON/OFF count monitor (advanced function setting level): Page 252

EMOV

Move to Calibration Level

Initial setting/communications protect must be 0.



Function

This parameter sets the password to move to the calibration level.

- Set the password to move to the calibration level. The password is 1201.
- Move to the calibration level either by pressing the Key or Key or by waiting for two seconds to elapse.



■ **Related Parameter**

Initial setting/communications protect (protect level): Page 160

5-9 Communications Setting Level

<i>PSEL</i>	Protocol Setting	Communications must be supported.
<i>U-N\bar{o}</i>	Communications Unit No.	
<i>bPS</i>	Communications Baud Rate	
<i>LEN</i>	Communications Data Length	CompoWay/F must be selected as the protocol.
<i>Sb$\bar{c}t$</i>	Communications Stop Bits	CompoWay/F must be selected as the protocol.
<i>PR$\bar{t}y$</i>	Communications Parity	
<i>Sd$\bar{w}t$</i>	Send Data Wait Time	

- Each parameter is enabled when the power is reset.
- Match the communications specifications of the E5□N and the host computer. If multiple devices are connected, ensure that the communications specifications for all devices in the system (except the Communications unit number) are the same.

Item	Symbol	Set values	Settings	Default
Protocol setting	<i>PSEL</i>	<i>ENF, M$\bar{o}d$</i>	CompoWay/F (SYSWAY), Modbus	<i>ENF</i>
Communications Unit No.	<i>U-N\bar{o}</i>	0 to 99	0 to 99	<i>1</i>
Communications baud rate	<i>bPS</i>	1.2, 2.4, 4.8, 9.6, 19.2, 38.4, or 57.6 (kbps)	1.2, 2.4, 4.8, 9.6, 19.2, 38.4, or 57.6 (kbps)	<i>9.6</i>
Communications data length	<i>LEN</i>	7 or 8 bits	7 or 8 bits	<i>7</i>
Stop bits	<i>Sb$\bar{c}t$</i>	1 or 2 bits	1 or 2 bits	<i>2</i>
Communications parity	<i>PR$\bar{t}y$</i>	<i>N$\bar{o}NE$, EV$\bar{E}N$, $\bar{o}dd$</i>	None, Even, Odd	<i>EV$\bar{E}N$</i>
Send data wait time	<i>Sd$\bar{w}t$</i>	0 to 99	0 to 99 (ms)	<i>20</i>

■ **Related Parameter**

Communications writing (adjustment level): Page 180



SECTION 6 CALIBRATION

This section describes how the user can calibrate the E5CN and E5CN-U Digital Temperature Controllers.

6-1	Parameter Structure	258
6-2	User Calibration	260
6-2-1	Calibrating Inputs	260
6-2-2	Registering Calibration Data	260
6-3	Thermocouple Calibration (Thermocouple/Resistance Thermometer Input) .	260
6-3-1	Preparations	261
6-4	Platinum Resistance Thermometer Calibration (Thermocouple/Resistance Thermometer Input)	264
6-5	Analog Input Calibration (Thermocouple/Resistance Thermometer Input) . .	265
6-6	Calibrating Analog Input (Analog Input)	267
6-6-1	Calibrating a Current Input	267
6-6-2	Calibrating a Voltage Input	268
6-7	Checking Indication Accuracy	270
6-7-1	Thermocouple or Infrared Temperature Sensor	270
6-7-2	Platinum Resistance Thermometer	271
6-7-3	Analog Input	272

6-1 Parameter Structure

- To execute user calibration, enter the password “1201” at the Move to Calibration Level parameter in the advanced function setting level. The mode will be changed to the calibration mode, and *RdU* will be displayed.
- The Move to Calibration Level parameter may not be displayed when the user is doing the calibration for the first time. If this happens, set the Initial Setting/Communications Protect parameter in the protect level to 0 before moving to the advanced function setting level.
- The calibration mode is ended by turning the power OFF.
- The parameter calibrations in the calibration mode are structured as shown below.

Controllers with Thermocouple/Resistance Thermometer Universal Inputs

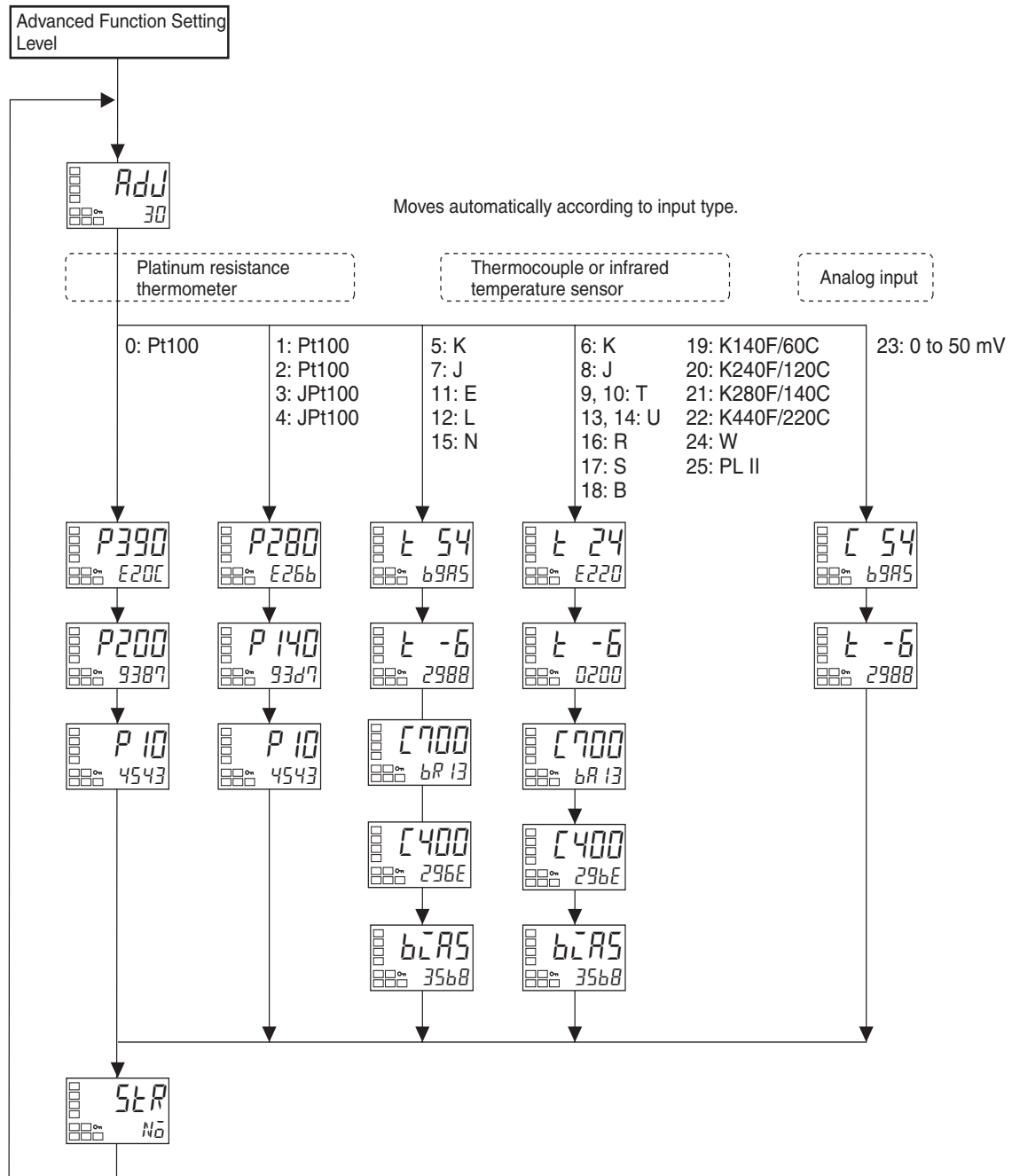

Controllers with an Analog Input

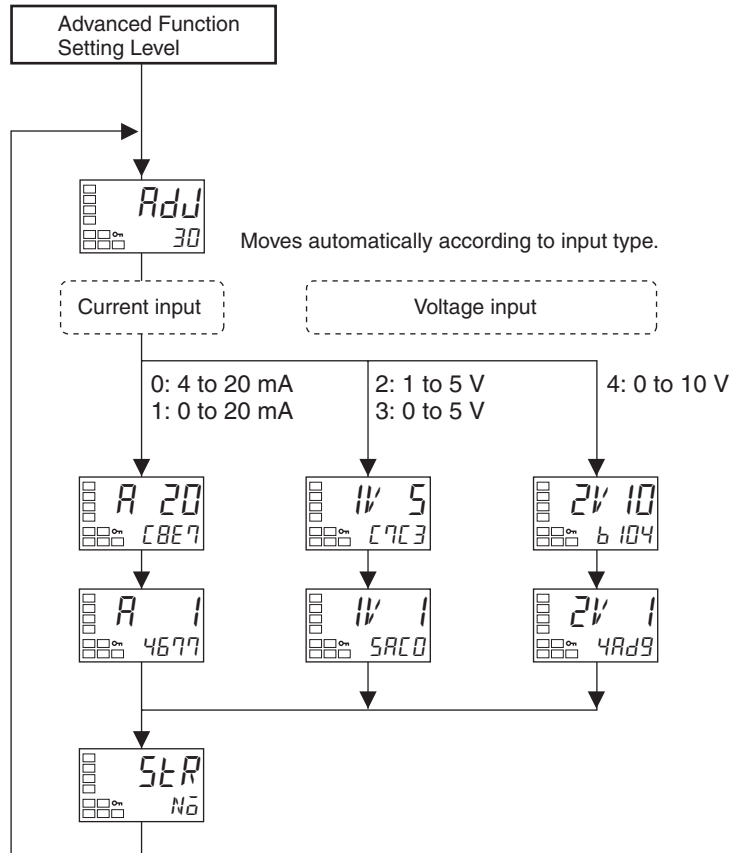

When calibration has been performed after purchase, the user calibration information shown in the following illustration will be displayed when moving to the calibration level.

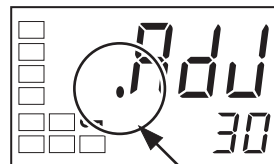

A dot is displayed.

6-2 User Calibration

The E5CN/CN-U/AN/EN/GN is correctly calibrated before it is shipped from the factory, and normally need not be calibrated by the user.

If, however, it must be calibrated by the user, use the parameters for calibrating temperature input and analog input. OMRON, however, cannot ensure the results of calibration by the user. Also, calibration data is overwritten with the latest calibration results. The default calibration settings cannot be restored after user calibration. Perform user calibration with care.

6-2-1 Calibrating Inputs

The input type selected in the parameter is used for calibration. The input types are as follows:

Controllers with Thermocouple/Resistance Thermometer Universal Inputs

- Thermocouple: 16 types
- Infrared temperature sensor: 4 types
- Analog input: 1 type
- Platinum resistance thermometer: 5 types

Controllers with Analog Inputs

- Current input: 2 types
- Voltage input: 3 types

6-2-2 Registering Calibration Data

The new calibration data for each item is temporarily registered. It can be officially registered as calibration data only when all items have been calibrated to new values. Therefore, be sure to temporarily register all items when you perform the calibration. When the data is registered, it is also recorded that user calibration has been performed.

Prepare separate measuring devices and equipment for calibration. For details on how to handle measuring devices and equipment, refer to the respective instruction manuals.

6-3 Thermocouple Calibration (Thermocouple/Resistance Thermometer Input)

- Calibrate according to the type of thermocouple: thermocouple 1 group (input types 5, 7, 11, 12, 15) and thermocouple 2 group (input types 6, 8, 9, 10, 13, 14, 16, 17, 18, 19, 20, 21, 22, 24, 25).
- When calibrating, do not cover the bottom of the Controller. Also, do not touch input terminals/pins (terminals 4 and 5 on the E5CN, pins 1 and 2 on the E5CN-U, pins 19 and 20 on the E5AN/E5EN, or pins 11 and 12 on the E5GN) or compensating conductors.

6-3-1 Preparations

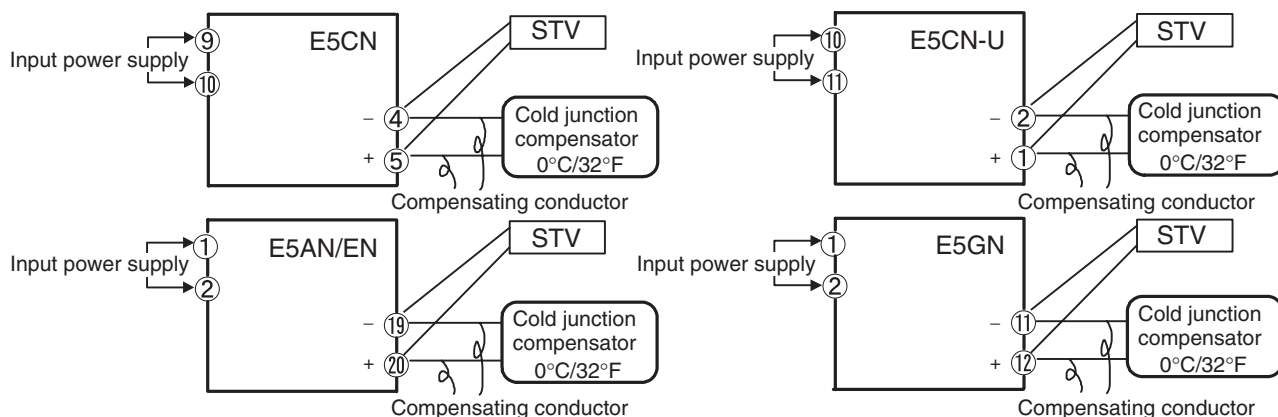

- Set the cold junction compensator designed for compensation of internal thermocouples to 0°C. Make sure that internal thermocouples are disabled (i.e., that tips are open).
- In the above figure, STV indicates a standard DC current/voltage source.
- Use the compensating conductor designed for the selected thermocouple. When thermocouples R, S, E, B, W, or PLII or an infrared temperature sensor is used, the cold junction compensator and the compensating conductor can be substituted with the cold junction compensator and the compensating conductor for thermocouple K.

■ Connecting the Cold Junction Compensator

Correct process values cannot be obtained if you touch the contact ends of the compensating conductor during calibration of a thermocouple. Accordingly, short-circuit (enable) or open (disable) the tip of the thermocouple inside the cold junction compensator as shown in the figure below to create a contact or non-contact state for the cold junction compensator.

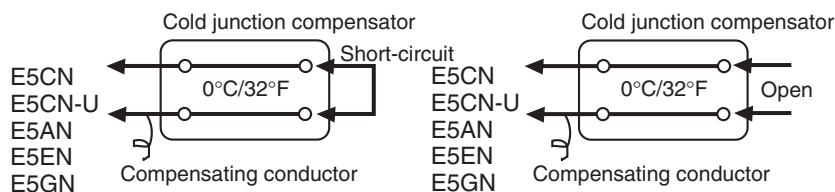

In this example, calibration is shown for a Controller with a Thermocouple/Resistance Thermometer Universal Input, with thermocouple/infrared temperature sensor set as the input type.

- 1,2,3... 1. Connect the power supply.
 2. Connect a standard DC current/voltage source (STV), precision digital multimeter (DMM), and contact junction compensator (e.g., a zero controller as in the figure) to the thermocouple input terminals, as shown in the figure below.

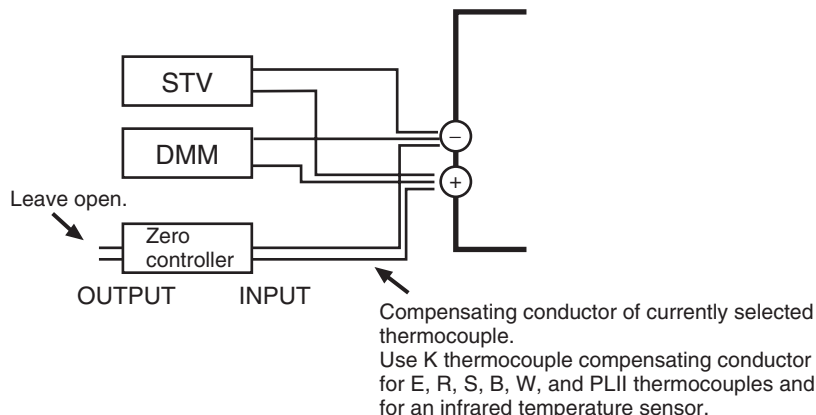

3. Turn the power ON.
 4. Move to the calibration level. This starts the 30-minute aging timer. This timer provides an approximate timer for aging. After 30 minutes have elapsed, the No. 2 display changes to 0. You can advance to the next step in this procedure even if 0 is not displayed.

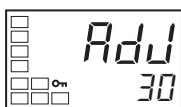

Input types 5, 7, 11, 12, 15:

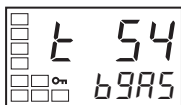

Input types 6, 8, 9, 10, 13, 14, 16, 17, 18, 19, 20, 21, 22, 24, 25:

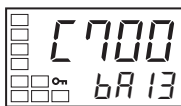
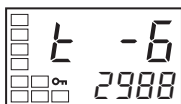
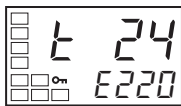

5. When the Key is pressed, the status changes as shown to the left. The No. 2 display at this time shows the currently entered count value in hexadecimal. Set the STV as follows:
- Input types 5, 7, 11, 12, 15: Set to 54 mV.
 - Input types 6, 8, 9, 10, 13, 14, 16, 17, 18, 19, 20, 21, 22, 24, 25: Set to 24 mV.
- Allow the count value on the No. 2 display to fully stabilize, then press the Key to temporarily register the calibration settings. If this count value is outside of the specified range, the No. 2 display will flash and the count value will not be temporarily registered.
6. When the Key is pressed, the status changes as shown to the left. Set the STV to -6 mV. Allow the count value on the No. 2 display to fully stabilize, then press the Key to temporarily register the calibration settings. If this count value is outside of the specified range, the No. 2 display will flash and the count value will not be temporarily registered.
7. Press the Key. The display changes as shown on the left. Set the STV to 700 mV. Allow the count value on the No. 2 display to fully stabilize, then press the Key to temporarily register the calibration settings. If this count value is outside of the specified range, the No. 2 display will flash and the count value will not be temporarily registered.

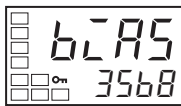
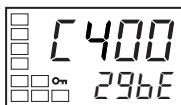

8. Press the Key. The display changes as shown on the left. Set the STV to 400 mV. Allow the count value on the No. 2 display to fully stabilize, then press the Key to temporarily register the calibration settings. If this count value is outside of the specified range, the No. 2 display will flash and the count value will not be temporarily registered.

9. When the Key is pressed, the status changes as shown to the left.

10. Change the wiring as follows:

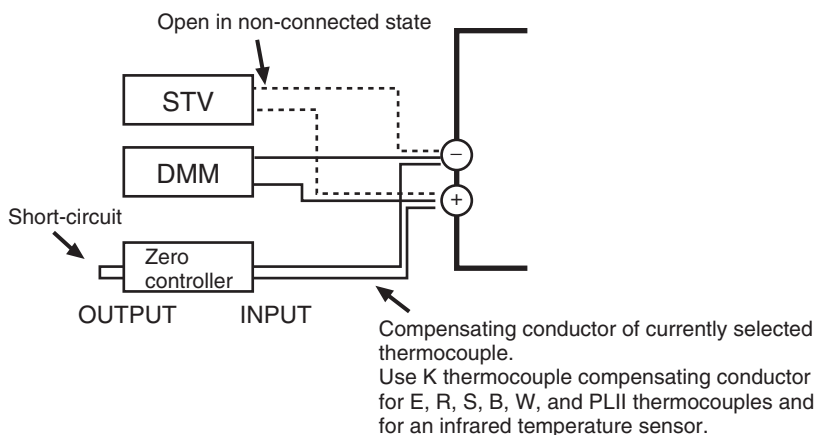

Disconnect the STV to enable the thermocouple of the cold junction compensator. When doing this, be sure to disconnect the wiring on the STV side.

11. Allow the count value on the No. 2 display to fully stabilize, then press the Key to temporarily register the calibration settings.
12. When the Key is pressed, the status changes as shown to the left. The data to be temporarily registered is not displayed if it is not complete. Press the Key. The No. 2 display changes to *4E5*. Release the key and wait two seconds or press the Key. This stores the temporarily registered calibration data to EEPROM. To cancel the saving of temporarily registered calibration data to EEPROM, press the Key (while *Nd* is displayed in the No. 2 display) without pressing the Key.
13. The calibration mode is ended by turning the power OFF.

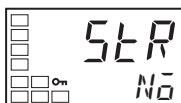

6-4 Platinum Resistance Thermometer Calibration (Thermocouple/Resistance Thermometer Input)

In this example, calibration is shown for Controller with a Thermocouple/Resistance Thermometer Universal Input, with a resistance thermometer set as the input type.

Use connecting wires of the same thickness.

- 1,2,3... 1. Connect the power supply.
2. Connect a precision resistance box (called a “6-dial” in this manual) to the platinum resistance thermometer input terminals, as shown in the following diagram.

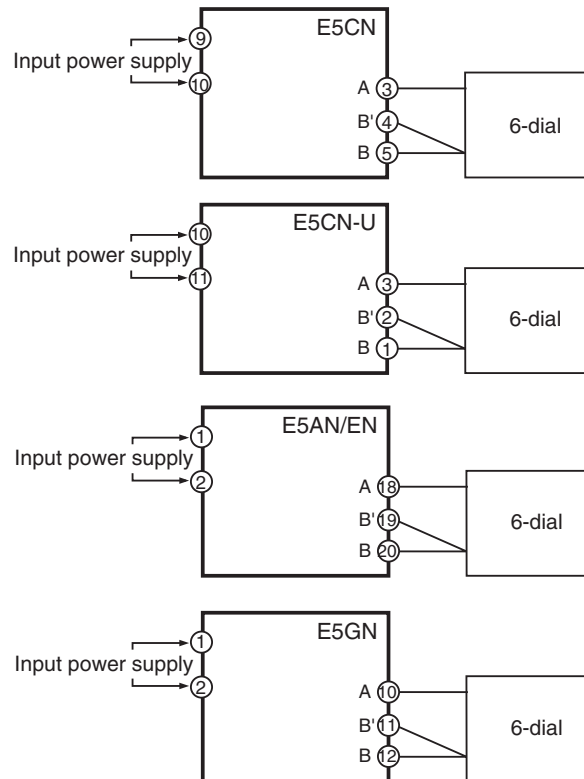

3. Turn the power ON.
4. Move to the calibration level.
This starts the 30-minute aging timer. This timer provides an approximate timer for aging. After 30 minutes have elapsed, the No. 2 display changes to 0. You can advance to the next step in this procedure even if 0 is not displayed.
5. Execute calibration for the main input.
Press the Key to display the count value for each input type. The No. 2 display at this time shows the currently entered count value in hexadecimal. Set the 6-dial as follows:

- Input type 0: 390 Ω
- Input type 1, 2, 3 or 4: 280 Ω

Allow the count value on the No. 2 display to fully stabilize, then press the Key to temporarily register the calibration settings. If this count value is outside of the specified range, the No. 2 display will flash and the count value will not be temporarily registered.

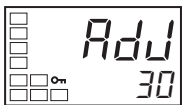

Input type 0:

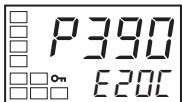

Input types 1, 2, 3, 4:

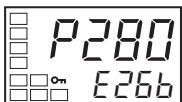

Input type 0:



Input types 1, 2, 3, 4:

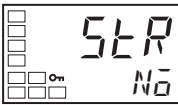
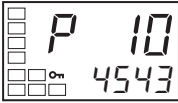

Press the Key to display the count value for each input type.

The No. 2 display at this time shows the currently entered count value in hexadecimal. Set the 6-dial as follows:

- Input type 0: 200 Ω
- Input type 1, 2, 3 or 4: 140 Ω

Allow the count value on the No. 2 display to fully stabilize, then press the Key to temporarily register the calibration settings.

If this count value is outside of the specified range, the No. 2 display will flash and the count value will not be temporarily registered.

- When the Key is pressed, the status changes as shown to the left. Set the 6-dial to 10 Ω.

Allow the count value on the No. 2 display to fully stabilize, then press the Key to temporarily register the calibration settings.

If this count value is outside of the specified range, the No. 2 display will flash and the count value will not be temporarily registered.

- When the Key is pressed, the status changes as shown to the left. The data to be temporarily registered is not displayed if it is not complete. Press the Key. The No. 2 display changes to 5E5. Release the key and wait two seconds or press the Key. This stores the temporarily registered calibration data to EEPROM.

To cancel the saving of temporarily registered calibration data to EEPROM, press the Key (while No is displayed in the No. 2 display) without pressing the Key.

- The calibration mode is quit by turning the power OFF.

6-5 Analog Input Calibration (Thermocouple/Resistance Thermometer Input)

In this example, calibration is shown for a Controller with a Thermocouple/Resistance Thermometer Universal Input, with an analog input (0 to 50 mV) set as the input type.

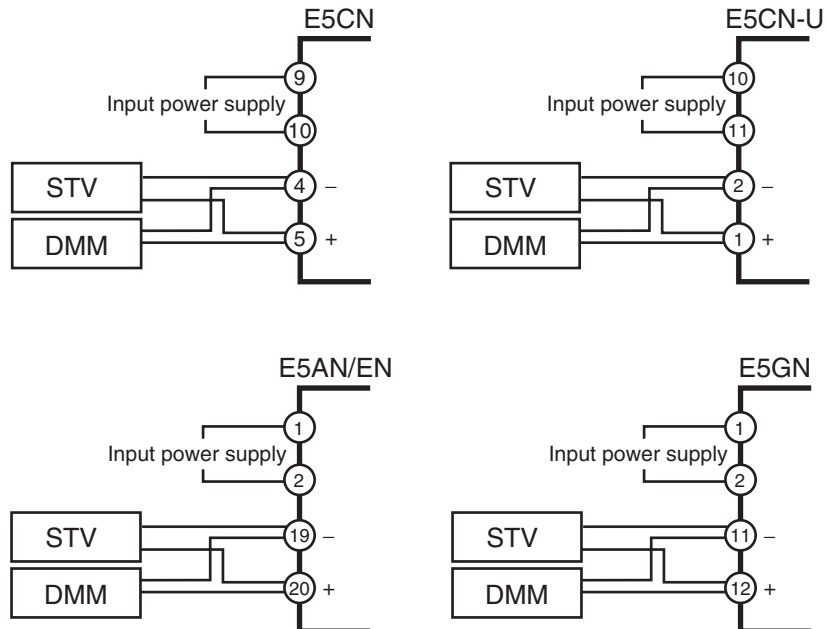

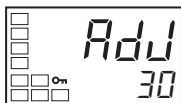

- 1,2,3... 1. Connect the power supply.
 2. Connect an STV and DMM to the analog input terminals (same as thermocouple inputs), as shown in the figure above.
 3. Turn the power ON.
 4. Move to the calibration level.

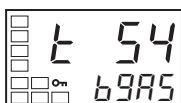

This starts the 30-minute aging timer. This timer provides an approximate timer for aging. After 30 minutes have elapsed, the No. 2 display changes to 0. You can advance to the next step in this procedure even if 0 is not displayed.





5. When the  Key is pressed, the status changes as shown to the left. The No. 2 display at this time shows the currently entered count value in hexadecimal. Set the STV to 54 mV.

Allow the count value on the No. 2 display to fully stabilize, then press the  Key to temporarily register the calibration settings.

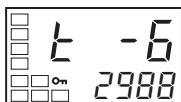
If this count value is outside of the specified range, the No. 2 display will flash and the count value will not be temporarily registered.





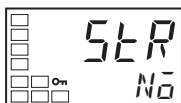

6. When the  Key is pressed, the status changes as shown to the left. Set the STV to -6 mV.

Allow the count value on the No. 2 display to fully stabilize, then press the  Key to temporarily register the calibration settings.

If this count value is outside of the specified range, the No. 2 display will flash and the count value will not be temporarily registered.



7. When the  Key is pressed, the status changes as shown to the left. The data to be temporarily registered is not displayed if it is not complete. Press the  Key. The No. 2 display changes to *4E5*. Release the key and wait two seconds or press the  Key. This stores the temporarily registered calibration data to EEPROM.

To cancel the saving of temporarily registered calibration data to EEPROM, press the  Key (while *N0* is displayed in the No. 2 display) without pressing the  Key.

8. The calibration mode is ended by turning the power OFF.

6-6 Calibrating Analog Input (Analog Input)

6-6-1 Calibrating a Current Input

In this example, calibration is shown for a Controller with an Analog Input, with a current input set as the input type.

- 1,2,3... 1. Connect the power supply.
 2. Connect an STV and DMM to the current input terminals, as shown in the following diagram.

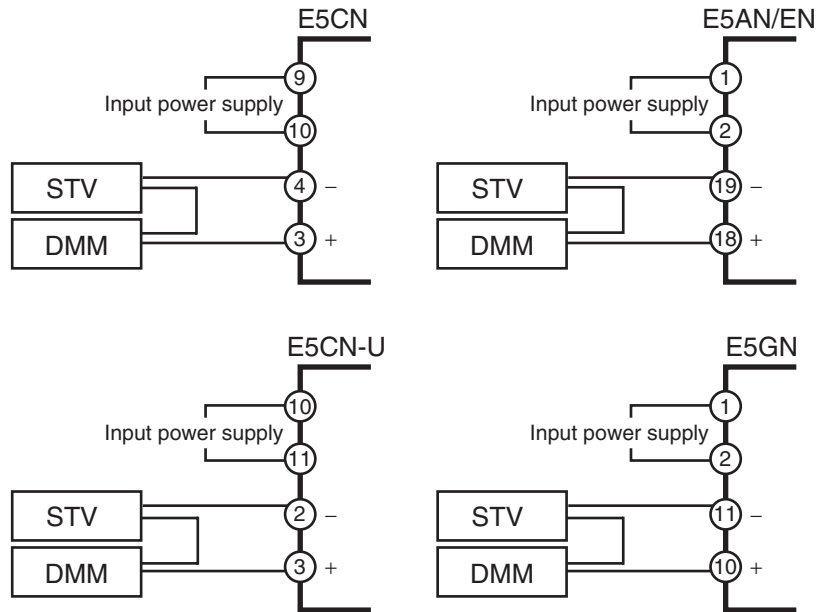

3. Turn the power ON.
 4. Move to the calibration level.
 This starts the 30-minute aging timer. This timer provides an approximate timer for aging. After 30 minutes have elapsed, the No. 2 display changes to 0. You can advance to the next step in this procedure even if 0 is not displayed.



5. When the Key is pressed, the status changes as shown to the left. The No. 2 display at this time shows the currently entered count value in hexadecimal. Set the STV to 20 mA.

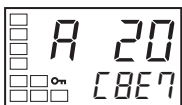





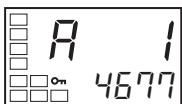

Allow the count value on the No. 2 display to fully stabilize, then press the Key to temporarily register the calibration settings. If this count value is outside of the specified range, the No. 2 display will flash and the count value will not be temporarily registered.

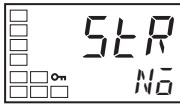
6. When the Key is pressed, the status changes as shown to the left. Set the STV to 1 mA.



Allow the count value on the No. 2 display to fully stabilize, then press the Key to temporarily register the calibration settings. If this count value is outside of the specified range, the No. 2 display will flash and the count value will not be temporarily registered.



7. When the  Key is pressed, the status changes as shown to the left. The data to be temporarily registered is not displayed if it is not complete. Press the  Key. The No. 2 display changes to *5E5*. Release the key and wait two seconds or press the  Key. This stores the temporarily registered calibration data to EEPROM. To cancel the saving of temporarily registered calibration data to EEPROM, press the  Key (while *No* is displayed in the No. 2 display) without pressing the  Key.
8. The calibration mode is ended by turning the power OFF.

6-6-2 Calibrating a Voltage Input

In this example, calibration is shown for a Controller with an Analog Input, with a voltage input set as the input type.

- 1,2,3...**
1. Connect the power supply.
 2. Connect an STV and DMM to the voltage input terminals, as shown in the following diagram.

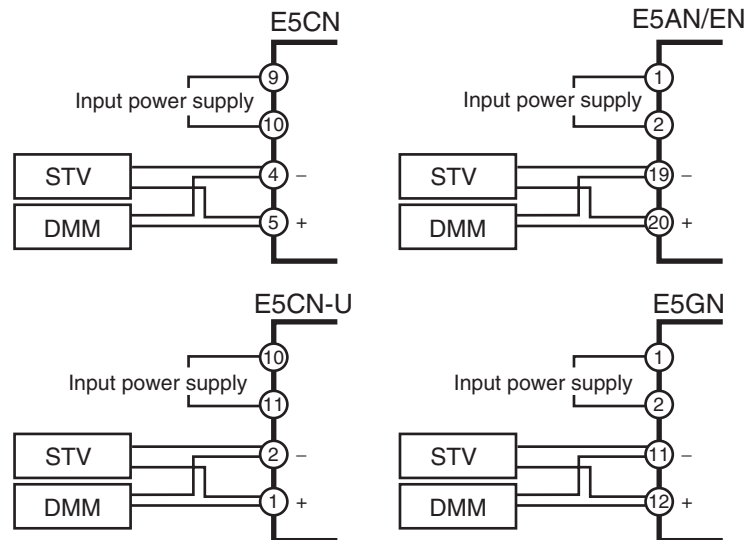

3. Turn the power ON.
4. Move to the calibration level. This starts the 30-minute aging timer. This timer provides an approximate timer for aging. After 30 minutes have elapsed, the No. 2 display changes to 0. You can advance to the next step in this procedure even if 0 is not displayed.

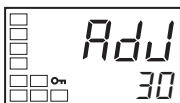



Input type 2 or 3:

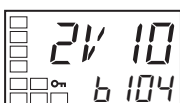

Input type 4:





5. When the  Key is pressed, the status changes as shown to the left. The No. 2 display at this time shows the currently entered count value in hexadecimal. Set the STV as follows:
 - Input type 2 or 3: 5 V
 - Input type 4: 10 V
 Allow the count value on the No. 2 display to fully stabilize, then press the  Key to temporarily register the calibration settings. If this count value is outside of the specified range, the No. 2 display will flash and the count value will not be temporarily registered.



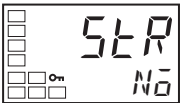
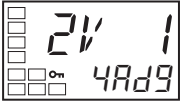

Input type 2 or 3:



Input type 4:



6. When the  Key is pressed, the status changes as shown to the left. Set the STV to 1 V.
 Allow the count value on the No. 2 display to fully stabilize, then press the  Key to temporarily register the calibration settings.
 If this count value is outside of the specified range, the No. 2 display will flash and the count value will not be temporarily registered.

7. When the  Key is pressed, the status changes as shown to the left. The data to be temporarily registered is not displayed if it is not complete. Press the  Key. The No. 2 display changes to *4E5*. Release the key and wait two seconds or press the  Key. This stores the temporarily registered calibration data to EEPROM.
 To cancel the saving of temporarily registered calibration data to EEPROM, press the  Key (while *N0* is displayed in the No. 2 display) without pressing the  Key.
8. The calibration mode is ended by turning the power OFF.

6-7 Checking Indication Accuracy

- After calibrating the input, be sure to check the indication accuracy to make sure that the calibration has been executed correctly.
- Operate the E5CN/CN-U/AN/EN in the process value/set point monitor mode.
- Check the indication accuracy at the following three values: upper limit, lower limit, and mid-point.

6-7-1 Thermocouple or Infrared Temperature Sensor

- Preparations

The diagram below shows the required device connections. Make sure that the E5CN/CN-U/AN/EN/GN and cold junction compensator are connected by a compensating conductor for the thermocouple that is to be used during actual operation.

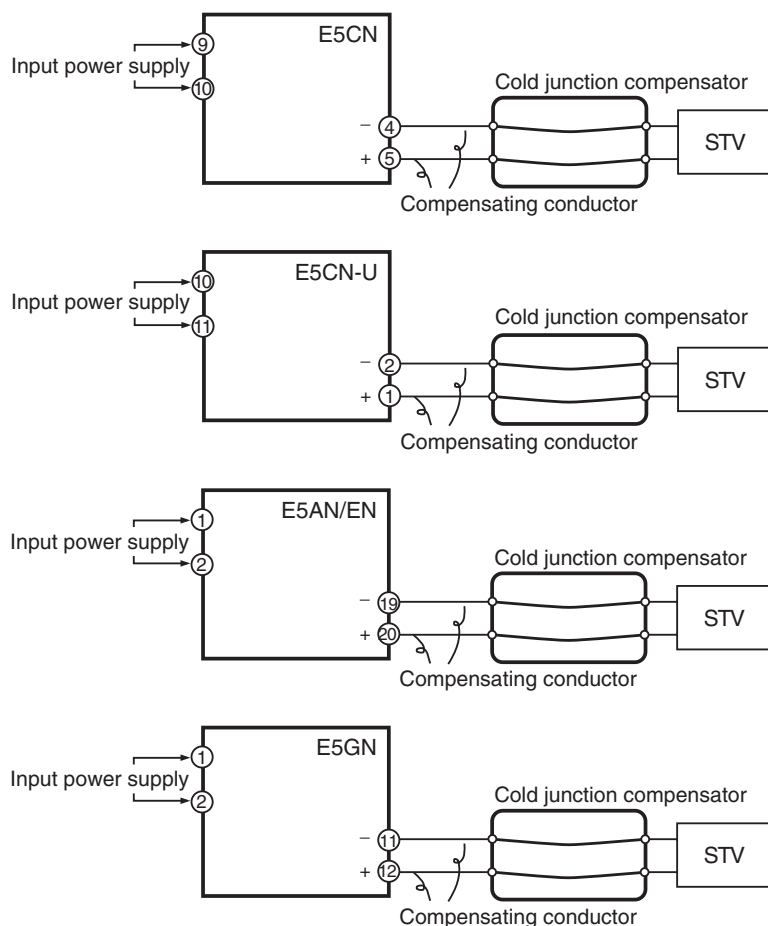

- Operation

Make sure that the cold junction compensator is at 0°C, and set the STV output to the voltage equivalent of the starting power of the check value. The cold junction compensator and compensation conductor are not required when an external cold junction compensation method is used.

6-7-2 Platinum Resistance Thermometer

- Preparations

The diagram below shows the required device connections.

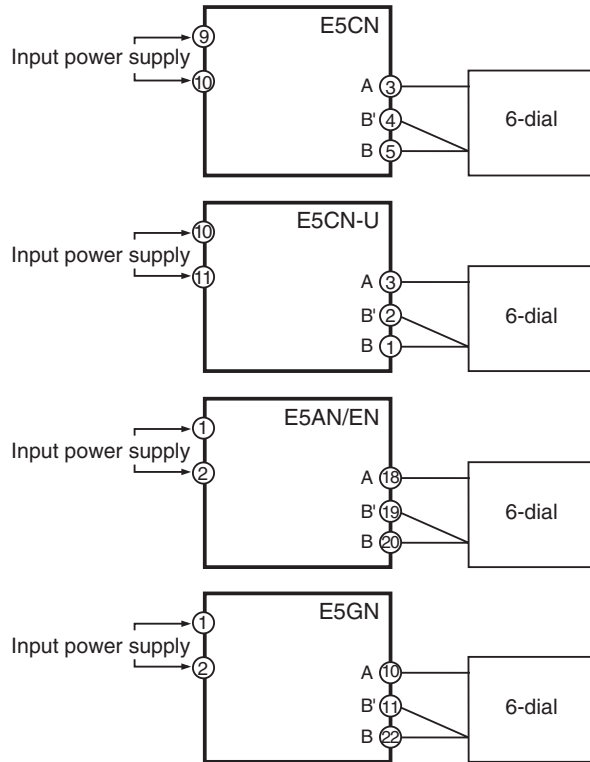

- Operation

Set the 6-dial to the resistance equivalent to the check value.

6-7-3 Analog Input

- Preparations

The diagram below shows the required device connections.

(The connection terminals depend on the model and input type.)

Controller with a Thermocouple/Resistance Thermometer Universal Input (Analog Input)

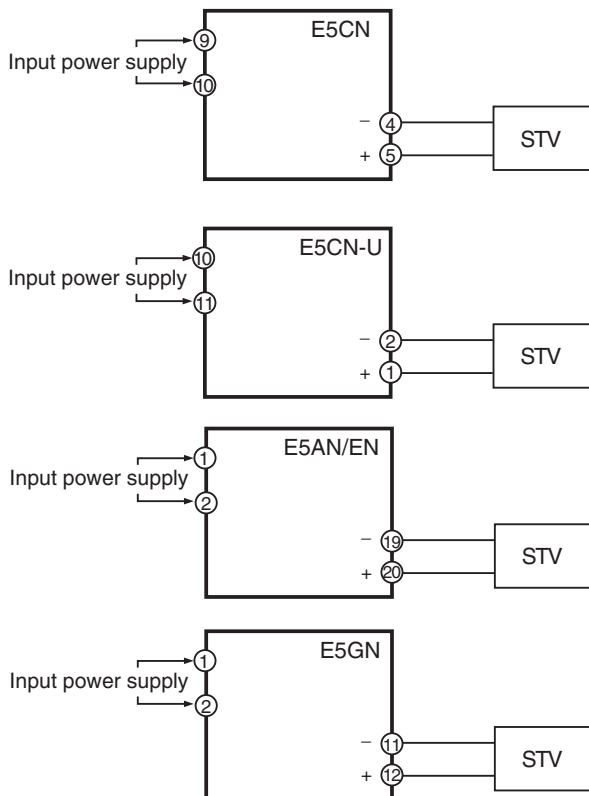

Current Input for a Controller with an Analog Input

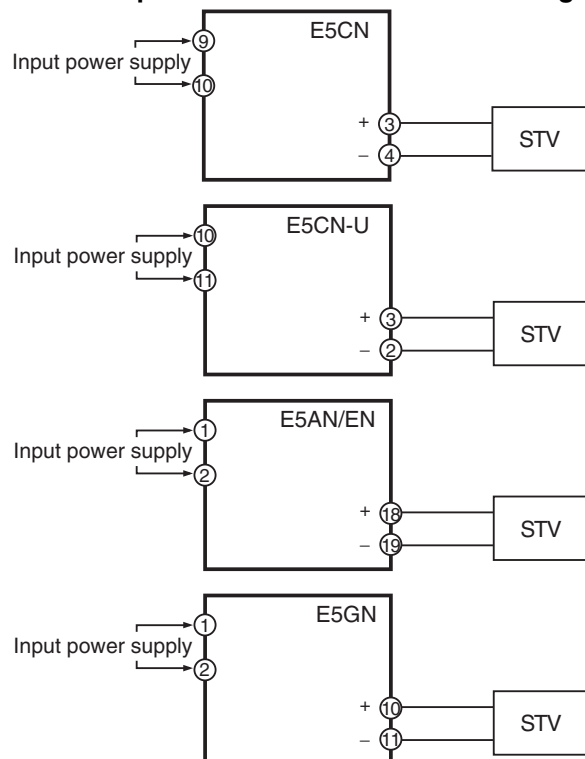

Voltage Input for a Controller with an Analog Input

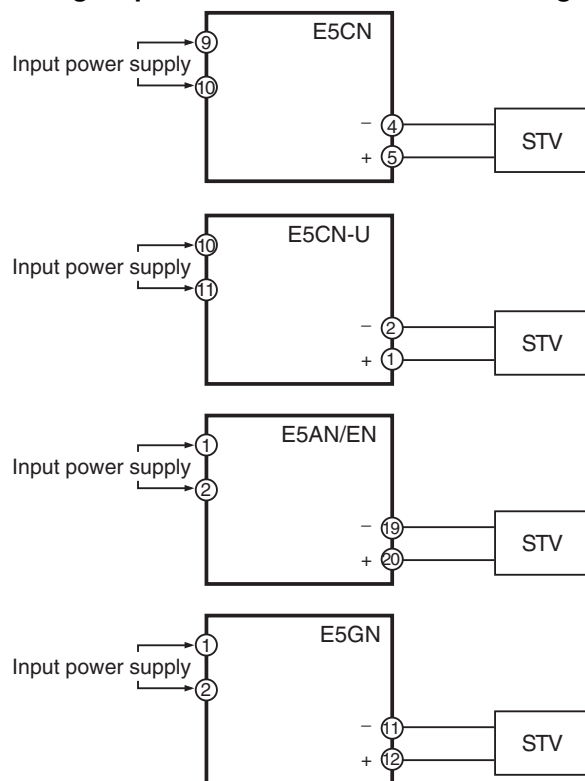

- Operation
Set the STV output to the voltage or current equivalent to the check value.

Appendix

Specifications

Ratings

Supply voltage		100 to 240 VAC, 50/60 Hz	24 VAC, 50/60 Hz/24 VDC	
Operating voltage range		85% to 110% of rated supply voltage		
Power consumption	E5CN	7.5 VA	5 VA/3 W	
	E5CN-U	6 VA	3 VA/2 W (4 VA/2 W for current output)	
	E5AN	10 VA	5.5 VA/4 W	
	E5EN	10 VA	5.5 VA/4 W	
	E5GN	5.5 VA	3 VA/2 W	
Sensor input (See note 1.)		Temperature input type Thermocouple: K, J, T, E, L, U, N, R, S, B, W, PLII Platinum resistance thermometer: Pt100, JPt100 Infrared temperature sensor: 10 to 70°C, 60 to 120°C, 115 to 165°C, 140 to 260°C Voltage input: 0 to 50 mV		
		Controllers with Analog Inputs (See note 2.) Current input: 4 to 20 mA, 0 to 20 mA (Input impedance: 150 Ω max.) Voltage input: 1 to 5 V, 0 to 5 V, 0 to 10 V (Input impedance: 1 MΩ max.)		
Control output	Relay output	E5CN	Relay output: SPST-NO, 250 VAC, 3 A (resistive load), electrical durability: 100,000 operations Min. applicable load: 5 V, 10 mA Long-life relay output (using a triac): SPST-NO, 250 VAC, 3 A (resistive load), electrical durability: 1,000,000 operations Load power supply voltage: 75 to 250 VAC (See note 3.) Leakage current: 5 mA max. (250 VAC, 60 Hz)	
		E5CN-U	SPDT, 250 VAC, 3A (resistive load), electrical durability: 100,000 operations Min. applicable load 5 V 10 mA	
		E5AN E5EN	Relay output: SPST-NO, 250 VAC, 5 A (resistive load), electrical durability: 100,000 operations Min. applicable load: 5 V, 10 mA Long-life relay output (using a triac): SPST-NO, 250 VAC, 3 A (resistive load), electrical durability: 1,000,000 operations Load power supply voltage: 75 to 250 VAC (See note 3.) Leakage current: 5 mA max. (250 VAC, 60 Hz)	
		E5GN	SPST-NO, 250 VAC, 2 A (resistive load), electrical durability: 100,000 operations, Min. applicable load: 5 V, 10 mA	
	Voltage output	E5CN E5CN-U	Output voltage 12 VDC ±15% (PNP), max. load current 21 mA, with short-circuit protection circuit	
		E5AN E5EN	Output voltage 12 VDC ±15% (PNP), max. load current 40 mA, with short-circuit protection circuit Note Control output 2: 12 VDC ±15% (PNP), max. load current 21 mA, with short-circuit protection circuit	
		E5GN	Output voltage 12 VDC ±15% (PNP), max. load current 21 mA, with short-circuit protection circuit	
	Current output	4 to 20 mA DC, 0 to 20 mA DC, Load: 500 Ω max. for E5GN and 600 Ω max. for other models, Resolution: Approx. 10,000		

Auxiliary output	E5CN E5CN-U	SPST-NO, 250 VAC, 3 A (resistive load), electrical durability: 100,000 operations Min. applicable load: 5 V, 10 mA
	E5AN E5EN	SPST-NO, 250 VAC, 3 A (resistive load), electrical durability: 100,000 operations Min. applicable load: 5 V, 10 mA
	E5GN	SPST-NO, 250 VAC, 2 A (resistive load), electrical durability: 100,000 operations, Min. applicable load: 5 V, 10 mA
Control method	2-PID or ON/OFF control	
Setting method	Digital setting using front panel keys	
Indication method	11-segment/7-segment digital display and single-lighting indicator	
Other functions	Depend on the model	
Ambient temperature	-10 to 55°C (with no condensation or icing); with 3-year guarantee: -10 to 50°C	
Ambient humidity	25% to 85%	
Storage temperature	-25 to 65°C (with no condensation or icing)	
Altitude	2,000 m or less	
Recommended fuse	T2A, 250 VAC, time lag, low shut-off capacity	
Installation environment	Installation Category II, Pollution Class 2 (IEC 61010-1 compliant)	

- Note**
- (1) For the setting ranges for each sensor input, see page 303.
 - (2) When connecting the ES2-THB, connect it 1:1.
 - (3) Always connect an AC load to a long-life relay output. The output will not turn OFF if a DC load is connected, because a triac is used for switching when closing and opening the circuit.

HB, HS, and Heater Overcurrent Alarms (for E5CN/AN/EN/GN Controllers with Heater Burnout, HS, and Heater Overcurrent Alarms)

Max. heater current	50 A AC
Input current readout accuracy	±5% FS ±1 digit max.
Heater burnout alarm setting range	0.1 to 49.9 A (0.1 A units) 0.0 A: Heater burnout alarm output turns OFF. 50.0 A: Heater burnout alarm output turns ON. Min. detection ON time: 100 ms (See note 1.)
HS alarm setting range	0.1 to 49.9 A (0.1 A units) 0.0 A: HS alarm output turns ON. 50.0 A: HS alarm output turns OFF. Min. detection OFF time: 100 ms (See note 2.)
Heater overcurrent alarm setting range	0.1 to 49.9 A (0.1 A units) 0.0 A: Heater overcurrent alarm output turns ON. 50.0 A: Heater overcurrent alarm output turns OFF. Min. detection OFF time: 100 ms

- Note**
- (1) When the control output 1 ON time is less than 100 ms, heater burnout detection, heater overcurrent detection, and heater current measurement are not performed.
 - (2) When the control output 1 OFF time is less than 100 ms, HS alarm, and leakage current measurement are not performed.

External Power Supply for ES1B

Output voltage	12 VDC ±10%
Output current	20 mA max.

Note Contact your OMRON representative for information on using the external power supply for ES1B for other applications.

Characteristics

Indication accuracy (ambient temperature of 23°C)	Thermocouple (See note 1.): E5CN/AN/EN/GN: ($\pm 0.3\%$ of PV or $\pm 1^\circ\text{C}$, whichever is greater) ± 1 digit max. E5CN-U: ($\pm 1\%$ of PV or $\pm 2^\circ\text{C}$, whichever is greater) ± 1 digit max. Platinum resistance thermometer: ($\pm 0.2\%$ of PV or $\pm 0.8^\circ\text{C}$, whichever is greater) ± 1 digit max. Analog input: $\pm 0.2\%$ FS ± 1 digit max. CT input: $\pm 5\%$ FS ± 1 digit max.			
Temperature variation influence (See note 2.)	Thermocouple (R, S, B, W, PLII) E5CN/AN/EN/GN: ($\pm 1\%$ of PV or $\pm 10^\circ\text{C}$, whichever is greater) ± 1 digit max. E5CN-U: ($\pm 2\%$ of PV or $\pm 10^\circ\text{C}$, whichever is greater) ± 1 digit max. Other thermocouples: E5CN/AN/EN/GN: ($\pm 1\%$ of PV or $\pm 4^\circ\text{C}$, whichever is greater) ± 1 digit max. E5CN-U: ($\pm 2\%$ of PV or $\pm 4^\circ\text{C}$, whichever is greater) ± 1 digit max.			
Voltage variation influence (See note 2.)	*K thermocouple at -100°C max: $\pm 10^\circ\text{C}$ max. Platinum resistance thermometer: ($\pm 1\%$ of PV or $\pm 2^\circ\text{C}$, whichever is greater) ± 1 digit max. Analog input: $\pm 1\%$ FS ± 1 digit max. CT input: $\pm 5\%$ FS ± 1 digit max.			
Hysteresis	Controllers with Thermocouple/ Resistance Thermometer Uni- versal Inputs	0.1 to 999.9°C or °F (in units of 0.1°C or °F) (See note 3.)		
	Controllers with Analog Inputs	0.01% to 99.99% FS (in units of 0.01% FS)		
Proportional band (P)	Controllers with Thermocouple/ Resistance Thermometer Uni- versal Inputs	0.1 to 999.9°C or °F (in units of 0.1 EU) (See note 3.)		
	Controllers with Analog Inputs	0.1% to 999.9% FS (in units of 0.1% FS) 0.01% to 99.99% FS (in units of 0.01% FS)		
Integral time (I)	0 to 3,999 s (in units of 1 s)			
Derivative time (D)	0 to 3,999 s (in units of 1 s) When RT is ON: 0.0 to 999.9 (in units of 0.1 s)			
Control Period	0.5, 1 to 99 s (in units of 1 s)			
Manual reset value	0.0% to 100.0% (in units of 0.1%)			
Alarm setting range	-1,999 to 9,999 (decimal point position depends on input type)			
Sampling period	250 ms			
Insulation resistance	20 M Ω min. (at 500 VDC)			
Dielectric strength	2,300 VAC, 50/60 Hz for 1 min between terminals of different charge			
Malfunction vibration	10 to 55 Hz, 20 m/s ² for 10 min each in X, Y and Z directions			
Vibration resistance	10 to 55 Hz, 20 m/s ² for 2 hr each in X, Y, and Z directions			
Malfunction shock	100 m/s ² , 3 times each in X, Y, and Z directions			
Shock resistance	300 m/s ² , 3 times each in X, Y, and Z directions			
Weight	E5CN	Approx. 150 g	Adapter: approx. 10 g	Terminal cover: approx. 10 g
	E5CN-U	Approx. 110 g		---
	E5AN	Approx. 310 g	Adapter: approx. 100 g	Terminal cover: approx. 1.6 g per cover
	E5EN	Approx. 260 g		
	E5GN	Approx. 90 g	Adapter: approx. 10 g	
Degree of protection	E5CN E5AN E5EN E5GN	Front panel: IP66 Rear case: IP20 Terminals: IP00		
	E5CN-U	Front panel: IP50, rear case: IP20, terminals: IP00		
Memory protection	EEPROM (non-volatile memory) (number of writes: 1,000,000)			



- Note**
- (1) The indication accuracy of K thermocouples in the -200 to $1,300^{\circ}\text{C}$ range, T and N thermocouples at a temperature of -100°C or less, and U and L thermocouples at any temperature is $\pm 2^{\circ}\text{C} \pm 1$ digit maximum. The indication accuracy of B thermocouples at a temperature of 400°C to $800 \pm 3^{\circ}\text{C}$ or less is not specified. The indication accuracy of R and S thermocouples at a temperature of 200°C or less is $\pm 3^{\circ}\text{C} \pm 1$ digit maximum. The indication accuracy of W thermocouples is (the larger of $\pm 0.3\%$ or $\pm 3^{\circ}\text{C}$) ± 1 digit maximum and the indication accuracy of PLII thermocouples is (the larger of $\pm 0.3\%$ or $\pm 2^{\circ}\text{C}$) ± 1 digit maximum.
 - (2) Ambient temperature: -10°C to 23°C to 55°C
Voltage range: -15 to $+10\%$ of rated voltage
 - (3) Set "None" as the unit for Controllers with Analog Inputs.

Rating and Characteristics of Options

Event inputs	Contact Input ON: $1\text{ k}\Omega$ max., OFF: $100\text{ k}\Omega$ min.
	Non-contact Input ON: Residual voltage 1.5 V max.; OFF: Leakage current 0.1 mA max.
Communications	Transmission path: RS-485/232C Communications method: RS-485 (2-wire, half duplex) or RS-232C Synchronization: Start-stop Baud rate: 1.2, 2.4, 4.8, 9.6, 19.2, 38.4, or 57.6 kbps
Transfer output	4 to 20 mA DC, Load: $600\ \Omega$ max., Resolution: 10,000, Accuracy: $\pm 0.3\%$

Waterproof Packing

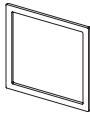
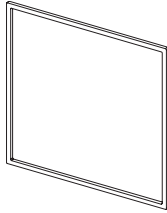
If the Waterproof Packing is lost or damage, order one of the following models.

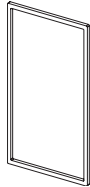
Y92S-29 (for DIN 48×48) 	Y92S-P4 (for DIN 96×96) 
Y92S-32 (for DIN 48×24) 	Y92S-P4 (for DIN 48×96) 

Current Transformer (CT)

Specifications

Item	Specifications	
Model number	E54-CT1	E54-CT3
Max. continuous current	50 A	120 A (See note.)
Dielectric strength	1,000 VAC (for 1 min)	
Vibration resistance	50 Hz, 98 m/s ²	
Weight	Approx. 11.5 g	Approx. 50 g
Accessories	None	Armature (2), Plug (2)

Note The maximum continuous current of the E5□N is 50 A.

External Dimensions

E54-CT1

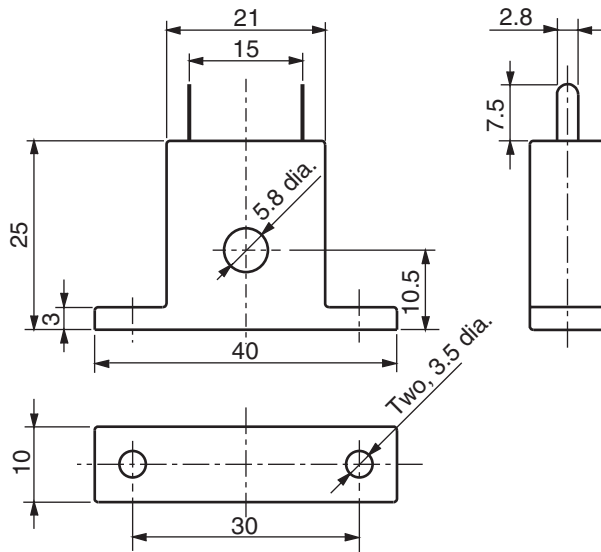

E54-CT3

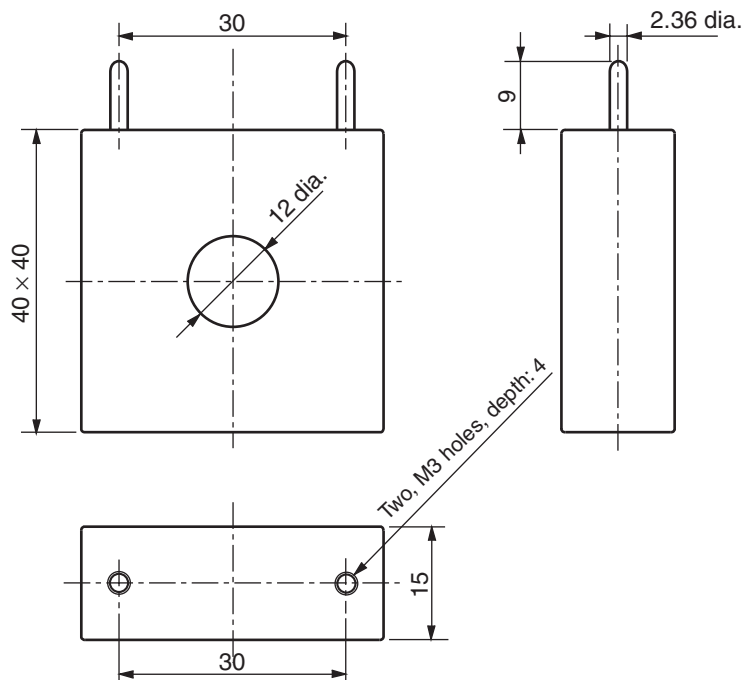

E58-CIFQ1 USB-Serial Conversion Cable

Specifications

Item	Specifications
Applicable OS	Windows 2000/XP/Vista
Applicable software	CX-Thermo
Applicable models	OMRON E5AN/EN/CN/CN-U/GN Digital Temperature Controllers
USB interface rating	Conforms to USB Specification 1.1
DTE speed	38,400 bps
Connector specifications	Computer end: USB (type A plug) Temperature Controller end: Serial
Power supply	Bus power (5 VDC supplied from USB host controller)
Current consumption	70 mA
Ambient operating temperature	0 to 55°C (with no condensation or icing)
Ambient operating humidity	10% to 80%
Storage temperature	-20 to 60°C (with no condensation or icing)
Storage humidity	10% to 80%
Altitude	2,000 m max.
Weight	Approx. 100 g

Compatible Operating Environment

A personal computer that includes the following specifications is required.

- USB port
- CD-ROM drive
- Windows 2000/XP/Vista

Appearance and Nomenclature

Appearance

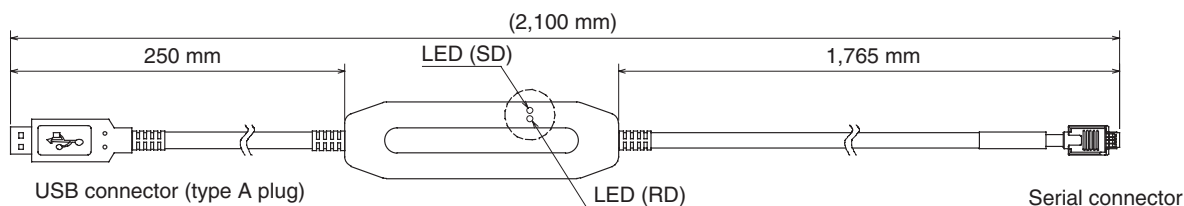

LED Indicator Display

Indicator	Color	Status	Meaning
SD	Yellow	Lit	Sending data from USB-Serial Conversion Cable
		Not lit	Not sending data from USB-Serial Conversion Cable
RD	Yellow	Lit	Receiving data from the USB-Serial Conversion Cable
		Not lit	Not receiving data from the USB-Serial Conversion Cable

Error Displays

When an error occurs, the error contents are shown on the No. 1 or the No. 2 display.

This section describes how to check error codes on the display, and the actions to be taken to remedy the problems.

Input Error

Meaning

The input value has exceeded the control range. (See note.)

The input type setting is not correct.

The sensor is disconnected or shorted.

The sensor wiring is not correct.

The sensor is not wired.

Note Control Range

Resistance thermometer, thermocouple input: Temperature setting lower limit -20°C to temperature setting upper limit $+20^{\circ}\text{C}$

(Temperature setting lower limit -40°F to temperature setting upper limit $+40^{\circ}\text{F}$)

ES1B input:

Same as input indication range

Analog input

-5% to $+105\%$ of scaling range

Action

Check the wiring of inputs for miswiring, disconnections, and short-circuits and check the input type.

If no abnormality is found in the wiring and input type, turn the power OFF then back ON again.

If the display remains the same, the Controller must be replaced. If the display is restored, then the probable cause is electrical noise affecting the control system. Check for electrical noise.

Note With resistance thermometer input, a break in the A, B, or B' line is regarded as a disconnection.

Operation at Error

After an error occurs, the error is displayed and the alarm outputs function as if the upper limit has been exceeded.

When the Input Error Output parameter in the advanced function setting level is set to ON, the output assigned to the alarm 1 function turns ON whenever an input error occurs.

An error message is displayed when the PV, PV/SP, or PV/MV is displayed.

Note The control output turns OFF. When the manual MV, MV at stop, or MV at PV error is set, however the control output corresponds to the set value.

Display Range Exceeded

Meaning

Though this is not an error, it is displayed if the process value exceeds the display range when the control range is larger than the display range.

The display ranges are shown below (with decimal points omitted).

• When less than $-1,999$ CCCCC

• When more than $9,999$ JJJJJ

Action

Control continues, allowing normal operation. The message is displayed when the PV, PV/SP, or PV/MV is displayed.

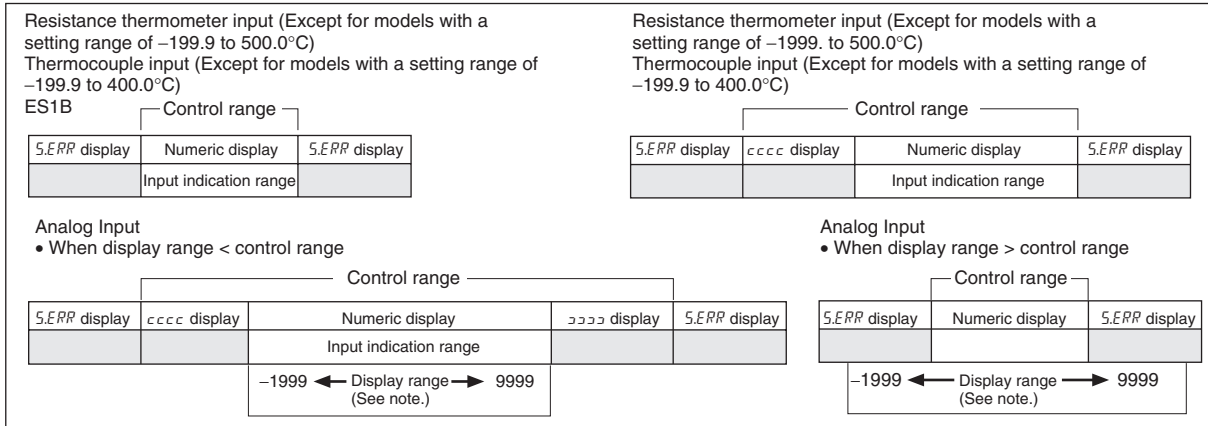

Note: The display range is shown in numbers with decimal points omitted.

E333

AD Converter Error

Meaning

There is an error in internal circuits.

Action

First, turn the power OFF then back ON again. If the display remains the same, the Controller must be repaired. If the display is restored, then the probable cause is electrical noise affecting the control system. Check for electrical noise.

Operation

Control output and alarm output turn OFF.

E111

Memory Error

Meaning

Internal memory operation is in error.

Action

First, turn the power OFF then back ON again. If the display remains the same, the Controller must be repaired. If the display is restored, then the probable cause is electrical noise affecting the control system. Check for electrical noise.

Operation at Error

Control output and alarm output turn OFF. (Current output is approx. 0 mA).

FFFF

Current Value Exceeds

Meaning

This error is displayed when the heater current value exceeds 55.0 A.

Action

Control continues, allowing normal operation. An error message is displayed when the following items are displayed.

- Heater current 1 value monitor
- Heater current 2 value monitor
- Leakage current 1 monitor
- Leakage current 2 monitor

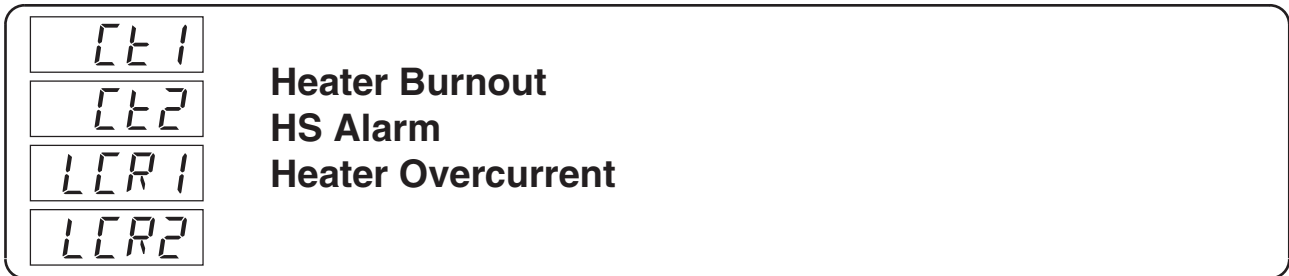

Meaning

When heater burnout, HS alarm, or heater overcurrent occurs, the No. 1 display in the applicable setting level flashes.

Action

When a heater burnout, HS error, or heater overcurrent is detected, the HA indicator lights and the No. 1 display flashes for the applicable Heater Current 1 Value Monitor, Heater Current 2 Value Monitor, Leakage Current 1 Monitor, or Leakage current 2 Monitor parameters in the operation level and adjustment level. Control continues, allowing normal operation.

Troubleshooting

Checking Problems

If the Temperature Controller is not operating normally, check the following points before requesting repairs. If the problem persists, contact your OMRON representative for details on returning the product.

Timing	Status	Meaning	Countermeasures	Page
Turning ON the power for the first time	Temperature unit (°C/°F) is flashing.	ST (self-tuning) is in progress (default setting: ON).	This is not a product fault. The temperature unit (°C/°F) flashes while ST (self-tuning) is being performed	64
	Temperature error is large. Input error (S.Err display)	Input type mismatch	Check the sensor type and reset the input type correctly.	52
		Thermometer is not installed properly.	Check the thermometer installation location and polarity and install correctly.	31
	Communications are not possible.	Non-recommended adapter is being used.	Make sure that the connected device is not faulty.	<i>Section 1 of Communications Manual</i>
	Communications are not possible.	Non-recommended adapter is being used.	Make sure that the connected device is not faulty.	(See note.)
During operation	Overshooting Undershooting Hunting	ON/OFF control is enabled (default: ON/OFF control selected).	Select PID control and execute either ST (self-tuning) or AT (auto-tuning). When using self-tuning, turn ON the power supply to the Temperature Controller and load (heater, etc.) at the same time, or turn ON the load power supply first. Accurate self-tuning and optimum control will not be possible if the power supply to the load is turned ON after turning ON the power supply to the Temperature Controller.	62
		Control cycle is longer compared with the speed of rise and fall in temperature	Shorten the control cycle. A shorter control cycle improves control performance, but a cycle of 20 ms minimum is recommended in consideration of the service life of the relays.	54
		Unsuitable PID constant	Set appropriate PID constants using either of the following methods. • Execute AT (autotuning). • Set PID constants individually using manual settings.	62
		HS alarm operation fault	Use breeder resistance if the problem is due to leakage current. Also investigate the errors detected by the HS alarm function.	54
	Temperature is not rising	Specified operation is unsuitable for required control (default: Reverse operation)	Select either forward or reverse operation depending on the required control. Reverse operation is used for heating operations.	54
		Heater is burnt out or deteriorated.	Check whether heater burnout or deterioration have occurred. Also investigate the errors detected by the heater burnout alarm.	54
		Insufficient heater capacity	Check whether the heater's heating capacity is sufficient.	---
		Cooling system in operation.	Check whether a cooling system is operating.	---
		Peripheral devices have heat prevention device operating.	Set the heating prevention temperature setting to a value higher than the set temperature of the Temperature Controller.	---

Note Refer to the *E5CN/E5AN/E5EN/E5GN Digital Temperature Controller Communications Manual* (Cat. No. H158) for details.

Timing	Status	Meaning	Countermeasures	Page
During operation (continued)	Output will not turn ON	Set to STOP (default: RUN)	Set the RUN/STOP mode to RUN. If STOP is lit on the display, control is stopped.	172
		Specified operation is unsuitable for required control (default: Reverse operation)	Select either forward or reverse operation depending on the required control. Reverse operation is used for heating operations.	54
		A high hysteresis is set for ON/OFF operation (default: 1.0°C)	Set a suitable value for the hysteresis.	60
	Temperature Controller will not operate	Set to STOP (default: RUN)	Set the RUN/STOP mode to RUN. If STOP is lit on the display, control is stopped.	172
	Temperature error is large Input error (S.err display)	Thermometer has burnt out or short-circuited.	Check whether the thermometer has burnt out or short-circuited	---
		Thermometer lead wires and power lines are in the same conduit, causing noise from the power lines (generally, display values will be unstable).	Wire the lead wires and power lines in separate conduits, or wiring using a more direct path.	---
		Connection between the Temperature Controller and thermocouple is using copper wires.	Connect the thermocouple's lead wires directly, or connect a compensating conductor suitable for the thermocouple.	---
		Installation location of thermometer is unsuitable.	Check whether the location of the thermometer is suitable.	---
		Input shift is not set correctly (default: 0°C)	Set a suitable input shift. If input shift is not required, set the input shift value to 0.0.	89
	Keys will not operate	Setting change protect is ON.	Turn OFF setting change protect.	110
Cannot shift levels	Operations limited due to protection.	Set the operation/adjustment protect, initial setting/communications protect, and setting change protect values as required.	110	
After long service life	Control is unstable	Terminal screws may be loose.	Retighten terminal screws to a torque of 0.74 to 0.90 N·m (see note).	33
		The internal components have reached the end of their service life.	The Temperature Controller's internal electrolytic capacitor depends on the ambient temperature, and load rate. The structural life depends on the ambient environment (shock, vibration). The life expectancy of the output relays varies greatly with the switching capacity and other switching conditions. Always use the output relays within their rated load and electrical life expectancy. If an output relay is used beyond its life expectancy, its contacts may become welded or burned. Replace the Temperature Controller and all other Temperature Controllers purchased in the same time period.	---

Note The tightening torque is 0.5 N·m for the E5CN-U and 0.43 to 0.58 N·m for the E5GN. The terminal torque is 0.5 to 0.6 N·m for auxiliary output 2 on the E5GN.

Symptom: Cannot Communicate or a Communications Error Occurs

Meaning	Countermeasures
The communications wiring is not correct.	Correct the wiring.
The communications line has become disconnected.	Connect the communications line securely and tighten the screws.
The communications cable is broken.	Replace the cable.
The communications cable is too long.	The total cable length is 500 m maximum for RS-485 and 15 m maximum for RS-232C communications. To extend the communications distance for RS-232C communications, use OMRON's Z3R Optical Interface.
The wrong communications cable has been used.	E5CN, E5EN, or E5AN: Use a shielded, AWG24 to AWG14 (cross-sectional area of 0.205 to 2.081 mm ²) twisted-pair cable for the communications cable. E5GN: Use a shielded, AWG24 to AWG18 (cross-sectional area of 0.205 to 0.823 mm ²) twisted-pair cable for the communications cable.
More than the specified number of communications devices are connected to the same communications path for RS-485 communications.	When 1:N RS-485 communications are used, a maximum of 32 nodes (including the host node) can be connected.
An end node has not been set at each end of the communications line for RS-485 communications.	Set or connect terminating resistance at each end of the line. If the E5CN, E5AN, E5EN, or E5GN is the end node, use 120-Ω (1/2-W) terminating resistance. The combined terminating resistance with the host device must be at least 54 Ω.
The specified power supply voltage is not being supplied to the Controller.	Supply the specified power supply voltage.
The specified power supply voltage is not being supplied to an Interface Converter (such as the K3SC).	Supply the specified power supply voltage.
The same baud rate and communications method are not being used by all of the Controllers, host devices, and other devices on the same communications line.	Set the same values for the baud rate, protocol, data length, stop bits, and parity on all nodes.
The unit number specified in the command frame is different from the unit number set by the Controller.	Use the same unit number.
The same unit number as the Controller is being used for another node on the same communications line for RS-485 communications.	Set each unit number for only one node.
There is a mistake in programming the host device.	Use a line monitor to check the commands. Check operation using a sample program.
The host device is detecting the absence of a response as an error before it receives the response from the Controller.	Shorten the send data wait time in the Controller or increase the response wait time in the host device.
The host device is detecting the absence of a response as an error after broadcasting a command (except for SYSWAY).	The Controller does not return responses for broadcast commands.
The host device sent another command before receiving a response from the Controller.	The response must always be read after sending a command (except for broadcast commands).
The host device sent the next command too soon after receiving a response from the Controller.	After receiving a response, wait at least 2 ms before sending the next command.

Meaning	Countermeasures
The communications line became unstable when Controller power was turned ON or interrupted, and the host device read the unstable status as data.	Initialize the reception buffer in the host device before sending the first command and after turning OFF the power to the Controller.
The communications data was corrupted from noise from the environment.	<p>Try using a slower baud rate.</p> <p>Separate the communications cable from the source of noise.</p> <p>Use a shielded, twisted-pair cable for the communications cable.</p> <p>Use as short a communications cable as possible, and do not lay or loop extra cable.</p> <p>To prevent inductive noise, do not run the communications cable parallel to a power line.</p> <p>If noise countermeasures are difficult to implement, use an Optical Interface.</p>

Note For details on errors, refer to *E5CN/E5AN/E5EN/E5GN Digital Temperature Controllers Communications Manual Basic Type* (Cat. No. H158).

Parameter Operation Lists

Universal input: Controllers with Thermocouple/Resistance Thermometer Universal Inputs

Analog input: Controllers with Analog Inputs

Operation Level

Parameters	Characters	Setting (monitor) value	Display	Default	Unit	Set value
Process Value		Temperature: According to indication range for each sensor. Analog: Scaling lower limit -5% FS to Scaling upper limit +5% FS			EU	
Set Point		SP lower limit to SP upper limit		0	EU	
Auto/Manual Switch	<i>A-M</i>					
Multi-SP Set Point Setting	<i>M-SP</i>	0 to 3		0	None	
Set Point During SP Ramp	<i>SP-M</i>	SP lower limit to SP upper limit			EU	
Heater Current 1 Value Monitor	<i>EL1</i>	0.0 to 55.0			A	
Heater Current 2 Value Monitor	<i>EL2</i>	0.0 to 55.0			A	
Leakage Current 1 Monitor	<i>ELR1</i>	0.0 to 55.0			A	
Leakage Current 2 Monitor	<i>ELR2</i>	0.0 to 55.0			A	
Program Start	<i>PRSt</i>	RSET, STRT	<i>RSEt, StRt</i>	RSET	None	
Soak Time Remain	<i>SKtR</i>	0 to 9999			min or h	
RUN/STOP	<i>R-S</i>	RUN/STOP	<i>RUN, StOP</i>	Run	None	
Alarm Value 1	<i>AL-1</i>	-1999 to 9999		0	EU	
Alarm Value Upper Limit 1	<i>AL1H</i>	-1999 to 9999		0	EU	
Alarm Value Lower Limit 1	<i>AL1L</i>	-1999 to 9999		0	EU	
Alarm Value 2	<i>AL-2</i>	-1999 to 9999		0	EU	
Alarm Value Upper Limit 2	<i>AL2H</i>	-1999 to 9999		0	EU	
Alarm Value Lower Limit 2	<i>AL2L</i>	-1999 to 9999		0	EU	
Alarm Value 3	<i>AL-3</i>	-1999 to 9999		0	EU	
Alarm Value Upper Limit 3	<i>AL3H</i>	-1999 to 9999		0	EU	
Alarm Value Lower Limit 3	<i>AL3L</i>	-1999 to 9999		0	EU	
MV Monitor (Heating)	<i>α</i>	-5.0 to 105.5 (standard) 0.0 to 105.0 (heating/cooling)			%	
MV Monitor (Cooling)	<i>EL-α</i>	0.0 to 105.0			%	

Adjustment Level

Parameters	Characters	Setting (monitor) value	Display	Default	Unit	Set value
Adjustment Level Display	<i>LAdj</i>					
AT Execute/Cancel	<i>At</i>	OFF, AT Cancel AT-2: 100%AT Execute AT-1: 40%AT Execute	<i>OFF,</i> <i>At-2,</i> <i>At-1</i>	OFF	None	
Communications Writing	<i>CMWt</i>	OFF, ON	<i>OFF,</i> <i>ON</i>	OFF	None	
Heater Current 1 Value Monitor	<i>Et1</i>	0.0 to 55.0			A	
Heater Burnout Detection 1	<i>Hb1</i>	0.0 to 50.0		0.0	A	
Heater Overcurrent Detection 1	<i>oEt1</i>	0.0 to 50.0		50.0	A	
Heater Current 2 Value Monitor	<i>Et2</i>	0.0 to 55.0			A	
Heater Burnout Detection 2	<i>Hb2</i>	0.0 to 50.0		0.0	A	
Heater Overcurrent Detection 2	<i>oEt2</i>	0.0 to 50.0		50.0	A	
Leakage Current 1 Monitor	<i>LEP1</i>	0.0 to 55.0			A	
HS Alarm 1	<i>HS1</i>	0.0 to 50.0		50.0	A	
Leakage Current 2 Monitor	<i>LEP2</i>	0.0 to 55.0			A	
HS Alarm 2	<i>HS2</i>	0.0 to 50.0		50.0	A	
SP 0	<i>SP-0</i>	SP lower limit to SP upper limit		0	EU	
SP 1	<i>SP-1</i>	SP lower limit to SP upper limit		0	EU	
SP 2	<i>SP-2</i>	SP lower limit to SP upper limit		0	EU	
SP 3	<i>SP-3</i>	SP lower limit to SP upper limit		0	EU	
Temperature Input Shift	<i>INS</i>	-199.9 to 999.9		0.0	°C or °F	
Upper Limit Temperature Input Shift Value	<i>INSH</i>	-199.9 to 999.9		0.0	°C or °F	
Lower Limit Temperature Input Shift Value	<i>INSL</i>	-199.9 to 999.9		0.0	°C or °F	
Proportional Band	<i>P</i>	Universal input: 0.1 to 999.9		8.0	°C or °F (See note 1.)	
		Analog input: 0.1 to 999.9		10.0	%FS	
Integral Time	<i>I</i>	0 to 3,999		233	Second	
Derivative Time	<i>d</i>	RT OFF: 0 to 3,999		40	Second	
		RT ON: 0.0 to 999.9		40.0	Second	
Cooling Coefficient	<i>E-5E</i>	0.01 to 99.99		1.00	None	
Dead Band	<i>E-db</i>	Universal input: -199.9 to 999.9		0.0	°C or °F (See note 1.)	
		Analog input: -19.99 to 99.99		0.00	%FS	

Parameters	Characters	Setting (monitor) value	Display	Default	Unit	Set value
Manual Reset Value	$\bar{a}F-R$	0.0 to 100.0		50.0	%	
Hysteresis (Heating)	$HY5$	Universal input: 0.1 to 999.9		1.0	°C or °F (See note 1.)	
		Analog input: 0.01 to 99.99		0.10	%FS	
Hysteresis (Cooling)	$\bar{L}HY5$	Universal input: 0.1 to 999.9		1.0	°C or °F (See note 1.)	
		Analog input: 0.01 to 99.99		0.10	%FS	
Soak Time	$\bar{S}oAK$	1 to 9,999		1	min or h	
Wait Band	$\bar{W}t-b$	Universal input: OFF, 0.1 to 999.9	$\bar{o}FF, 0.1$ to 999.9	OFF	°C or °F (See note 1.)	
		Analog input: OFF, 0.01 to 99.99	$\bar{o}FF, 0.01$ to 99.99	OFF	%FS	
MV at Stop	$\bar{M}V-S$	-5.0 to 105.0 (standard) -105.0 to 105.0 (heating/cooling)		0.0	%	
MV at PV Error	$\bar{M}V-E$	-5.0 to 105.0 (standard) -105.0 to 105.0 (heating/cooling)		0.0	%	
SP Ramp Set Value	$\bar{S}PRt$	OFF or 1 to 9,999	$\bar{o}FF, 1$ to 9999	OFF	EU/s, EU/min, EU/h	
MV Upper Limit	$\bar{a}L-H$	MV lower limit +0.1 to 105.0 (standard) 0.0 to 105.0 (heating/cooling)		105.0	%	
MV Lower Limit	$\bar{a}L-L$	-5.0 to MV upper limit -0.1 (standard) -105.0 to 0.0 (heating/cooling)		-5.0 (standard) -105.0 (heating/cooling)	%	
MV Change Rate Limit	$\bar{a}RL$	0.0 to 100.0 (0.0: MV Change Rate Limit Disabled)		0.0	%/s	
Extraction of Square Root Low-cut Point	$\bar{S}ORP$	0.0 to 100.0		0.0	%	

Initial Setting Level

Parameters	Characters	Setting (monitor) value	Display	Default	Unit	Set value
Input Type	$\bar{I}N-L$	Multi-input 0: Pt100 1: Pt100 2: Pt100 3: JPt100 4: JPt100 5: K 6: K 7: J 8: J 9: T 10: T 11: E 12: L 13: U 14: U 15: N 16: R 17: S 18: B 19: 10 to 70°C 20: 60 to 120°C 21: 115 to 165°C 22: 160 to 260°C 23: 0 to 50 mV 24: W 25: PLII		5	None	
		Analog input 0: 4 to 20 mA 1: 0 to 20 mA 2: 1 to 5 V 3: 0 to 5 V 4: 0 to 10 V		0	None	
Scaling Upper Limit	$\bar{I}N-H$	Scaling lower limit + 1 to 9,999		100	None	
Scaling Lower Limit	$\bar{I}N-L$	-1,999 to scaling upper limit -1		0	None	
Decimal Point	dP	Universal input: 0 to 1		0	None	
		Analog input: 0 to 3		0	None	
Temperature Unit	$d-U$	°C, °F	\bar{C}, F	°C	None	
SP Upper Limit	$\bar{S}L-H$	SP lower limit + 1 / input range lower limit (temperature)		1300	EU	
		SP lower limit + 1 / scaling upper limit (analog)		100		
SP Lower Limit	$\bar{S}L-L$	Input range lower limit to SP upper limit - 1 (temperature)		-200	EU	
		Scaling lower limit to SP upper limit - 1 (analog)		0		
PID ON/OFF	$\bar{I}N\bar{E}L$	ON/OFF 2-PID	$\bar{O}N\bar{O}F, P\bar{L}d$	ON/OFF	None	
Standard or Heating/Cooling	$\bar{S}-H\bar{C}$	Standard or heating/cooling	$\bar{S}\bar{E}N\bar{d}, H-\bar{C}$	Standard	None	
ST	$\bar{S}\bar{E}$	OFF, ON	$\bar{O}FF, \bar{O}N$	ON	None	
Program Pattern	$P\bar{L}RN$	OFF, STOP, CONT	$\bar{O}FF, \bar{S}\bar{E}\bar{O}P, \bar{C}\bar{O}N\bar{T}$	OFF	None	
Control Period (Heating)	$\bar{C}P$	0.5 or 1 to 99	$\bar{O}.5, 1 \text{ to } 99$	20	Second	
Control Period (Cooling)	$\bar{C}-\bar{C}P$	0.5 or 1 to 99	$\bar{O}.5, 1 \text{ to } 99$	20	Second	

Parameters	Characters	Setting (monitor) value	Display	Default	Unit	Set value
Direct/Reverse Operation	$\bar{a}REV$	Reverse operation, direct operation	$\bar{a}R-R, \bar{a}R-d$	Reverse operation	None	
Alarm 1 Type	$RLt1$	0: Alarm function OFF 1: Upper and lower-limit alarm 2: Upper-limit alarm 3: Lower-limit alarm 4: Upper and lower-limit range alarm 5: Upper and lower-limit alarm with standby sequence 6: Upper-limit alarm with standby sequence 7: Lower-limit alarm with standby sequence 8: Absolute-value upper-limit alarm 9: Absolute-value lower-limit alarm 10: Absolute-value upper-limit alarm with standby sequence 11: Absolute-value lower-limit alarm with standby sequence 12: LBA (Loop Burnout Alarm) 13: PV change rate alarm		2	None	
Alarm 1 Hysteresis	$RLH1$	Universal input: 0.1 to 999.9		0.2	°C or °F (See note 1.)	
		Analog input: 0.01 to 99.99		0.02	%FS	
Alarm 2 Type	$RLt2$	Same settings as the alarm 1 type. Note The 12: LBA (Loop Burnout Alarm) setting cannot be used.		2	None	
Alarm 2 Hysteresis	$RLH2$	Universal input: 0.1 to 999.9		0.2	°C or °F (See note 1.)	
		Analog input: 0.01 to 99.99		0.02	%FS	
Alarm 3 Type	$RLt3$	Same settings as the alarm 2 type		2	None	
Alarm 3 Hysteresis	$RLH3$	Universal input: 0.1 to 999.9		0.2	°C or °F (See note 1.)	
		Analog input: 0.01 to 99.99		0.02	%FS	
Transfer Output Type	$tR-t$	OFF: OFF SP: Set point SP-M: Ramp set point PV: Process value MV: Manipulated variable (heating) C-MV: Manipulated variable (cooling)	$\bar{a}FF$ SP $SP-M$ PV MV $C-MV$	OFF	None	
Transfer Output Upper Limit	$tR-H$	See note 2.		See note 2.	See note 2.	
Transfer Output Lower Limit	$tR-L$	See note 2.		See note 2.	See note 2.	

Parameters	Characters	Setting (monitor) value	Display	Default	Unit	Set value
Linear Current Output	$\bar{a}I-t$	4-20: 4 to 20 mA 0-20: 0 to 20 mA	$4-20, 0-20$	4-20	None	
Multi-SP Use	$E\bar{V}-M$	0 to 2		1	None	
Event Input Assignment 1	$E\bar{V}-1$	None: None STOP: RUN/STOP MANU: Auto/Manual PRST: Program Start (See note 3.) DRS: Invert Direct/Reverse Operation AT-2: 100% AT Execute/Cancel AT-1: 40% AT Execute/Cancel WTPT: Setting Change Enable/Disable LAT: Alarm Latch Cancel	$NONE$ $STOP$ $MANU$ $PRST$ DRS $AT-2$ $AT-1$ $WTPT$ LAT	NONE	None	
Event Input Assignment 2	$E\bar{V}-2$	None: None STOP: RUN/STOP MANU: Auto/Manual PRST: Program Start (See note 3.) DRS: Invert Direct/Reverse Operation AT-2: 100% AT Execute/Cancel AT-1: 40% AT Execute/Cancel WTPT: Setting Change Enable/Disable LAT: Alarm Latch Cancel	$NONE$ $STOP$ $MANU$ $PRST$ DRS $AT-2$ $AT-1$ $WTPT$ LAT	STOP	None	
Extraction of Square Root Enable	SQR	OFF, ON	$\bar{O}FF,$ $\bar{O}N$	OFF	None	
Move to Advanced function Setting Level	$AM\bar{a}V$	-1999 to 9,999		0	None	

Note (1) Set "None" as the unit for analog inputs (23: 0 to 50 mV).
(2)

Transfer output type	Setting (monitor) range	Default (transfer output upper/lower limits) (See note 2.1.)	Unit
Set Point	SP lower limit to SP upper limit	SP upper limit/lower limit	EU
Set Point During SP Ramp	SP lower limit to SP upper limit	SP upper limit/lower limit	EU
PV	Temperature: Input setting range lower limit to input setting range upper limit	Input setting range upper/lower limit	EU
	Analog: Scaling lower limit to scaling upper limit	Scaling upper/lower limit	EU
MV Monitor (Heating)	Standard: -5.0 to 105.0 Heating/cooling: 0.0 to 105.0	100.0/0.0	%
MV Monitor (Cooling)	0.0 to 105.0	100.0/0.0	%

(2.1) Initialized when the transfer output type is changed.

Initialized if the input type, temperature unit, scaling upper/lower limit, or SP upper/lower limit is changed when the transfer output type is SP, ramp SP, or PV.

(When initialized by the initializing settings, it is initialized to 100.0/0.0.)

(3) PRST (Program Start) can be set even when the Program Pattern parameter is set to OFF, but the function will be disabled.

Manual Control Level

Parameters	Characters	Setting (monitor) value	Display	Default	Unit	Set value
Manual MV		-5.0 to 105.0 (standard) (See note.) -105.0 to 105.0 (heating/cooling) (See note.)		0.0	%	

Note When the Manual MV Limit Enable parameter is set to ON, the setting range will be the MV lower limit to the MV upper limit.

Monitor/Setting Item Level

The contents displayed vary depending on the Monitor/Setting 1 to 5 (advanced function setting level) setting.

Advanced Function Setting Level

Parameters	Characters	Setting (monitor) value	Display	Default	Unit	Set value
Parameter Initialization	$\bar{C}NLE$	OFF, FACT	$\bar{a}FF, FAcLE$	OFF	None	
Multi-SP Uses	$MSPU$	OFF, ON	$\bar{a}FF, \bar{a}N$	OFF	None	
SP Ramp Time Unit	$SPRU$	S: EU/second M: EU/minute H: EU/hour	S M H	M	None	
Standby Sequence Reset	$RESEt$	Condition A, condition B	R, b	Condition A	None	
HB ON/OFF	HbU	OFF, ON	$\bar{a}FF, \bar{a}N$	ON	None	
Auxiliary Output 1 Open in Alarm	$5b1N$	N-O: Close in alarm N-C: Open in alarm	$N-\bar{a}, N-\bar{C}$	N-O	None	
Auxiliary Output 2 Open in Alarm	$5b2N$	N-O: Close in alarm N-C: Open in alarm	$N-\bar{a}, N-\bar{C}$	N-O	None	
Auxiliary Output 3 Open in Alarm	$5b3N$	N-O: Close in alarm N-C: Open in alarm	$N-\bar{a}, N-\bar{C}$	N-O	None	
Heater Burnout Latch	HbL	OFF, ON	$\bar{a}FF, \bar{a}N$	OFF	None	
Heater Burnout Hysteresis	HbH	0.1 to 50.0		0.1	A	
ST Stable Range	$St-b$	0.1 to 999.9		15.0	°C or °F	
α	$RLFR$	0.00 to 1.00		0.65	None	
AT Calculated Gain	$RE-G$	0.1 to 10.0		0.8	None	
AT Hysteresis	$RE-H$	Universal input: 0.1 to 999.9		0.8	°C or °F (See note 1.)	
		Analog input: 0.01 to 9.99		0.20	%FS	
Limit Cycle MV Amplitude	$LCMA$	5.0 to 50.0		20.0	%	
Input Digital Filter	$\bar{C}NF$	0.0 to 999.9		0.0	Second	
Additional PV Display	$PVAd$	OFF, ON	$\bar{a}FF, \bar{a}N$	OFF	None	
MV Display	$\bar{a}-dP$	OFF, ON	$\bar{a}FF, \bar{a}N$	OFF	None	
Automatic Display Return Time	REt	OFF or 1 to 99	$\bar{a}FF, 1$ to 99	OFF	Second	
Alarm 1 Latch	$R1LE$	OFF, ON	$\bar{a}FF, \bar{a}N$	OFF	None	
Alarm 2 Latch	$R2LE$	OFF, ON	$\bar{a}FF, \bar{a}N$	OFF	None	
Alarm 3 Latch	$R3LE$	OFF, ON	$\bar{a}FF, \bar{a}N$	OFF	None	
Move to Protect Level Time	$PRLE$	1 to 30		3	Second	
Input Error Output	$SERo$	OFF, ON	$\bar{a}FF, \bar{a}N$	OFF	None	

Parameters	Characters	Setting (monitor) value	Display	Default	Unit	Set value
Cold junction Compensation Method	$\overline{CJ\overline{C}}$	OFF, ON	$\overline{\alpha FF}, \overline{\alpha N}$	ON	None	
MB Command Logic Switching	\overline{RLRV}	OFF, ON	$\overline{\alpha FF}, \overline{\alpha N}$	OFF	None	
PV Change Color	$\overline{C\alpha LR}$	Orange, Red, Green Red to Green: When ALM1 is lit, Green to Red: When ALM1 is lit Red to Green to Red Within PV stable band: Green Outside stable band: Red Green to Orange to Red Within PV stable band: Green Outside stable band: Green, Red Orange to Green to Red Within PV stable band: Green Outside stable band: Green, Red	$\overline{\alpha RG}, \overline{REd}, \overline{GRN}$ $\overline{R-G}$ $\overline{G-R}$ $\overline{R-G.R}$ $\overline{G-\alpha.R}$ $\overline{\alpha-G.R}$	RED	None	
PV Stable Band	$\overline{PV-b}$	Universal input: 0.1 to 999.9		5.0	°C or °F (See note 1.)	
		Analog input: 0.01 to 99.99		5.00	%FS	
Alarm 1 ON Delay	$\overline{R1\alpha N}$	0 to 999 (0: ON delay disabled)		0	Second	
Alarm 2 ON Delay	$\overline{R2\alpha N}$	0 to 999 (0: ON delay disabled)		0	Second	
Alarm 3 ON Delay	$\overline{R3\alpha N}$	0 to 999 (0: ON delay disabled)		0	Second	
Alarm 1 OFF Delay	$\overline{R1\alpha F}$	0 to 999 (0: OFF delay disabled)		0	Second	
Alarm 2 OFF Delay	$\overline{R2\alpha F}$	0 to 999 (0: OFF delay disabled)		0	Second	
Alarm 3 OFF Delay	$\overline{R3\alpha F}$	0 to 999 (0: OFF delay disabled)		0	Second	
Input Shift Type	$\overline{C5\overline{LP}}$	INS1: Temperature input 1-point shift INS2: Temperature input 2-point shift	$\overline{CNS1}, \overline{CNS2}$	INS1	None	
MV at Stop and Error Addition	$\overline{MV5\overline{E}}$	OFF, ON	$\overline{\alpha FF}, \overline{\alpha N}$	OFF	None	
Auto/Manual Select Addition	$\overline{RMR\alpha d}$	OFF, ON	$\overline{\alpha FF}, \overline{\alpha N}$	OFF	None	
RT	\overline{RE}	OFF, ON	$\overline{\alpha FF}, \overline{\alpha N}$	OFF	None	
HS Alarm Use	\overline{HSU}	OFF, ON	$\overline{\alpha FF}, \overline{\alpha N}$	ON	None	
HS Alarm Latch	\overline{HSL}	OFF, ON	$\overline{\alpha FF}, \overline{\alpha N}$	OFF	None	
HS Alarm Hysteresis	\overline{HSH}	0.1 to 50.0		0.1	A	
LBA Detection Time	\overline{LbR}	0 to 9999 (0: LBA function disabled)		0	Second	
LBA Level	\overline{LbRL}	Universal input: 0.1 to 999.9		8.0	°C or °F (See note 1.)	
		Analog input: 0.01 to 99.99		10.00	%FS	

Parameters	Characters	Setting (monitor) value	Display	Default	Unit	Set value
LBA Band	<i>LbAb</i>	Universal input: 0.0 to 999.9		3.0	°C or °F (See note 1.)	
		Analog input: 0.00 to 99.99		0.20	%FS	
Control Output 1 Assignment	<i>āUt 1</i>	When control output 1 is a voltage output (for driving SSR) (See note 2.): NONE: No assignment O: Control output (heating) C-O: Control output (cooling) ALM1: Alarm 1 ALM2: Alarm 2 ALM3: Alarm 3 P.END: Program end output (See note 3.) RALM: Control output ON/OFF count alarm (See note 4.) WR1: Work bit 1 (See note 5.) WR2: Work bit 2 (See note 5.) WR3: Work bit 3 (See note 5.) WR4: Work bit 4 (See note 5.) WR5: Work bit 5 (See note 5.) WR6: Work bit 6 (See note 5.) WR7: Work bit 7 (See note 5.) WR8: Work bit 8 (See note 5.)	<i>NāNE</i> <i>ā</i> <i>[-ā</i> <i>ALM 1</i> <i>ALM 2</i> <i>ALM 3</i> <i>P.END</i> <i>RALM</i> <i>WR 1</i> <i>WR 2</i> <i>WR 3</i> <i>WR 4</i> <i>WR 5</i> <i>WR 6</i> <i>WR 7</i> <i>WR 8</i>	O	None	
		When control output 1 is a current output (See note 2.): NONE: No assignment O: Control output (heating) C-O: Control output (cooling)	<i>NāNE</i> <i>ā</i> <i>[-ā</i>			
Control Output 2 Assignment	<i>āUt 2</i>	NONE: No assignment O: Control output (heating) C-O: Control output (cooling) ALM1: Alarm 1 ALM2: Alarm 2 ALM3: Alarm 3 P.END: Program end output (See note 3.) RALM: Control output ON/OFF count alarm (See note 4.) WR1: Work bit 1 (See note 5.) WR2: Work bit 2 (See note 5.) WR3: Work bit 3 (See note 5.) WR4: Work bit 4 (See note 5.) WR5: Work bit 5 (See note 5.) WR6: Work bit 6 (See note 5.) WR7: Work bit 7 (See note 5.) WR8: Work bit 8 (See note 5.)	<i>NāNE</i> <i>ā</i> <i>[-ā</i> <i>ALM 1</i> <i>ALM 2</i> <i>ALM 3</i> <i>P.END</i> <i>RALM</i> <i>WR 1</i> <i>WR 2</i> <i>WR 3</i> <i>WR 4</i> <i>WR 5</i> <i>WR 6</i> <i>WR 7</i> <i>WR 8</i>	NONE	None	

Parameters	Characters	Setting (monitor) value	Display	Default	Unit	Set value
Auxiliary Output 1 Assignment	<i>SUb1</i>	NONE: No assignment O: Control output (heating) C-O: Control output (cooling) ALM1: Alarm 1 ALM2: Alarm 2 ALM3: Alarm 3 P.END: Program end output (See note 3.) RALM: Control output ON/OFF count alarm (See note 4.) WR1: Work bit 1 (See note 5.) WR2: Work bit 2 (See note 5.) WR3: Work bit 3 (See note 5.) WR4: Work bit 4 (See note 5.) WR5: Work bit 5 (See note 5.) WR6: Work bit 6 (See note 5.) WR7: Work bit 7 (See note 5.) WR8: Work bit 8 (See note 5.)	<i>NONE</i> <i>ō</i> <i>Ĉ-ō</i> <i>ALM1</i> <i>ALM2</i> <i>ALM3</i> <i>P.END</i> <i>RRLM</i> <i>WR1</i> <i>WR2</i> <i>WR3</i> <i>WR4</i> <i>WR5</i> <i>WR6</i> <i>WR7</i> <i>WR8</i>	ALM1	None	
Auxiliary Output 2 Assignment	<i>SUb2</i>	Same as for control output 1.		ALM2	None	
Auxiliary Output 3 Assignment (E5AN/E5EN only)	<i>SUb3</i>	Same as for control output 1.		ALM3	None	
Character Select	<i>ĈSEL</i>	OFF, ON	<i>ōFF, ōN</i>	ON	None	
Soak Time Unit	<i>Ē-U</i>	M: Minutes; H: Hours	<i>M, H</i>	M	None	
Alarm SP Selection	<i>ALSP</i>	SP-M: Ramp set point SP: Set point	<i>SP-M, SP</i>	SP-M	None	
Manual MV Limit Enable	<i>MANL</i>	OFF, ON	<i>ōFF, ōN</i>	ON	None	
PV Rate of Change Calculation Period	<i>PV RP</i>	1 to 999		4	Sampling period	
Automatic Cooling Coefficient Adjustment	<i>ĈSCR</i>	OFF, ON	<i>ōFF, ōN</i>	OFF	None	
Heater Overcurrent Use	<i>ōĈU</i>	OFF, ON	<i>ōFF, ōN</i>	ON	None	
Heater Overcurrent Latch	<i>ōĈL</i>	OFF, ON	<i>ōFF, ōN</i>	OFF	None	
Heater Overcurrent Hysteresis	<i>ōĈH</i>	0.1 to 50.0		0.1	A	
PF Setting	<i>PF</i>	OFF: OFF RUN: RUN STOP: STOP R-S: RUN/STOP AT-2: 100% AT execute/cancel AT-1: 40% AT execute/cancel LAT: Alarm Latch Cancel A-M: Auto/manual PFDP: Monitor/setting item	<i>ōFF</i> <i>RUN</i> <i>StōP</i> <i>R-S</i> <i>AL-2</i> <i>AL-1</i> <i>LAL</i> <i>A-M</i> <i>PFdP</i>	A-M	None	

Parameters	Characters	Setting (monitor) value	Display	Default	Unit	Set value
Monitor/Setting Item 1	<i>PFd1</i>	0: Disabled 1: PV/SP/Multi-SP 2: PV/SP/MV 3: PV/SP/Soak time remain 4: Proportional band (P) 5: Integral time (I) 6: Derivative time (D) 7: Alarm value 1 8: Alarm value upper limit 1 9: Alarm value lower limit 1 10: Alarm value 2 11: Alarm value upper limit 2 12: Alarm value lower limit 2 13: Alarm value 3 14: Alarm value upper limit 3 15: Alarm value lower limit 3		1	None	
Monitor/Setting Item 2	<i>PFd2</i>	0 to 15: Same as for Monitor/Setting Item 1.		0	None	
Monitor/Setting Item 3	<i>PFd3</i>	0 to 15: Same as for Monitor/Setting Item 1.		0	None	
Monitor/Setting Item 4	<i>PFd4</i>	0 to 15: Same as for Monitor/Setting Item 1.		0	None	
Monitor/Setting Item 5	<i>PFd5</i>	0 to 15: Same as for Monitor/Setting Item 1.		0	None	
PV/SP Display Screen Selection	<i>SPdP</i>	0: PV/SP 1: PV/SP/Multi-SP, PV/SP/MV 2: PV/SP/MV, PV/SP/Multi-SP 3: PV/SP/Multi-SP 4: PV/SP/MV 5: PV/SP/Multi-SP, PV/SP/Soak Time Remain 6: PV/SP/MV, PV/SP/Soak Time Remain 7: PV/SP/Soak Time Remain		4	None	
MV Display Selection	<i>adSL</i>	O: MV (Heating) C-O: MV (Cooling)	$\bar{0}$ $\bar{C} - \bar{0}$	0	None	
PV Decimal Point Display	<i>PvdP</i>	OFF, ON	$\bar{0}FF$, $\bar{0}N$	ON	None	
PV Status Display Function	<i>PvSt</i>	OFF: OFF MANU: Manual STOP: Stop ALM1: Alarm 1 ALM2: Alarm 2 ALM3: Alarm 3 ALM: Alarm 1 to 3 OR status HA: Heater alarm	$\bar{0}FF$ <i>MANU</i> <i>StOP</i> <i>ALM1</i> <i>ALM2</i> <i>ALM3</i> <i>ALM</i> <i>HA</i>	OFF	None	
SV Status Display Function	<i>SvSt</i>	OFF: OFF MANU: Manual STOP: Stop ALM1: Alarm 1 ALM2: Alarm 2 ALM3: Alarm 3 ALM: Alarm 1 to 3 OR status HA: Heater alarm	$\bar{0}FF$ <i>MANU</i> <i>StOP</i> <i>ALM1</i> <i>ALM2</i> <i>ALM3</i> <i>ALM</i> <i>HA</i>	OFF	None	
Display Refresh Period	<i>dREF</i>	OFF, 0.25, 0.5, 1.0		0.25	Second	
Control Output 1 ON/OFF Count Monitor	<i>RA1M</i>	0 to 9999			100 times	
Control Output 2 ON/OFF Count Monitor	<i>RA2M</i>	0 to 9999			100 times	

Parameters	Characters	Setting (monitor) value	Display	Default	Unit	Set value
Control Output 1 ON/OFF Count Alarm Set Value	<i>RR1</i>	0 to 9999		0	100 times	
Control Output 2 ON/OFF Count Alarm Set Value	<i>RR2</i>	0 to 9999		0	100 times	
ON/OFF Counter Reset	<i>RRC</i>	0: Disable the counter reset function. 1: Reset the control output 1 ON/OFF counter. 2: Reset the control output 2 ON/OFF counter.		0	None	
Move to Calibration Level	<i>CMOV</i>	-1999 to 9,999		0	None	

- Note**
- (1) Set "None" as the unit for analog inputs (23: 0 to 50 mV).
 - (2) The setting range depends on whether control output 1 is a current output or voltage output (for driving SSR).
 - (3) P.END (program end output) can be set even when the program pattern is set to OFF, but the function will be disabled.
 - (4) Turns ON when either the control output 1 or 2 ON/OFF count alarm is ON.
 - (5) Displayed when logic operations are used. For detail, refer to 4-22 *Logic Operations*.

Protect Level

Parameters	Characters	Setting (monitor) value	Display	Default	Unit	Set value
Move to Protect level	<i>PMOV</i>	-1999 to 9,999		0	None	
Operation/Adjustment Protect	<i>OPPL</i>	0 to 3		0	None	
Initial Setting/Communications Protect	<i>ICPL</i>	0 to 2		1	None	
Setting Change Protect	<i>WLPL</i>	OFF, ON	<i>OFF, ON</i>	OFF	None	
PF Key Protect	<i>PFPL</i>	OFF, ON	<i>OFF, ON</i>	OFF	None	
Parameter Mask Enable	<i>PMSE</i>	OFF, ON	<i>OFF, ON</i>	ON	None	
Password to Move to Protect Level	<i>PRLP</i>	-1999 to 9,999		0	None	

Communications Setting Level

Parameters	Characters	Setting (monitor) value	Display	Default	Unit	Set value
Protocol Setting	<i>PSEL</i>	CompoWay/F (SYSWAY), Modbus (See note.)	<i>CFW, Mod</i>	CompoWay/F (SYSWAY)	None	
Communications Unit No.	<i>U-NO</i>	0 to 99		1	None	
Communications Baud Rate	<i>bps</i>	1.2, 2.4, 4.8, 9.6, 19.2, 38.4, or 57.6	<i>1.2, 2.4, 4.8, 9.6, 19.2, 38.4, 57.6</i>	9.6	kbps	
Communications Data Length	<i>LEN</i>	7, 8		7	Bit	
Communications Stop Bits	<i>SBIT</i>	1, 2		2	Bit	
Communications Parity	<i>PRTY</i>	None, Even, Odd	<i>NONE, EVEN, odd</i>	Even	None	
Send Data Wait Time	<i>SDWT</i>	0 to 99		20	ms	

- Note** When setting CWF, either CompoWay/F or SYSWAY can be used as the communications protocol. (CompoWay/F and SYSWAY are automatically identified by the command frames.)

Initialization According to Parameter Changes

The parameters that are initialized when parameters are changed are shown under *Related initialized parameters*.

Changed parameter Related initialized parameters	Input type	Temperature unit	Scaling Lower Limit Scaling Upper Limit	SP Lower Limit SP Upper Limit	Standard or Heating/ Cooling	Program Pattern	Transfer Output Type	Number of Multi-SP Uses	RT	SP0 to SP3 Set Point
Related parameter initialization execution condition		Temperature input	Analog input							
SP Upper Limit SP Lower Limit	● (See note 1.)	● (See note 1.)	● (See note 1.)	---	---	---	---	---	---	---
Set Point	● (See note 2.)	● (See note 2.)	● (See note 2.)	● (See note 2.)	---	---	---	---	---	● (See note 11.)
SP0 to SP3	● (See note 2.)	● (See note 2.)	● (See note 2.)	● (See note 2.)	---	---	---	---	---	● (See note 11.)
RT	● (See note 3.)	---	---	---	---	---	---	---	---	---
Proportional Band (See note 10.)	● (See note 3.)	---	---	---	---	---	---	---	● (See note 9.)	---
Integral Time (See note 10.)	● (See note 3.)	---	---	---	---	---	---	---	● (See note 9.)	---
Derivative Time (See note 10.)	● (See note 3.)	---	---	---	---	---	---	---	● (See note 9.)	---
MV Upper Limit, MV Lower Limit	---	---	---	---	● (See note 5.)	---	---	---	---	---
MV at Stop	---	---	---	---	●	---	---	---	---	---
MV at PV Error	---	---	---	---	●	---	---	---	---	---
Manual MV	---	---	---	---	---	---	---	---	---	---
Transfer Output Upper Limit, Transfer Output Lower Limit (See note 4.)	● (See note 4-1.)	● (See note 4-1.)	● (See note 4-1.)	● (See note 4-1.)	● (See note 4-2.)	---	● (See note 4-3.)	---	---	---
Control Output 1 Assignment	---	---	---	---	●	●	---	---	---	---
Control Output 2 Assignment	---	---	---	---	● (See note 6.)	● (See note 6.)	---	---	---	---
Auxiliary Output 1 Assignment	---	---	---	---	● (See note 7.)	● (See note 7.)	---	---	---	---
Auxiliary Output 2 Assignment	---	---	---	---	● (See note 6.)	● (See note 6.)	---	---	---	---
Auxiliary Output 3 Assignment	---	---	---	---	● (See note 6.)	● (See note 6.)	---	---	---	---
Event Input Assignment 1	---	---	---	---	---	● (See note 8.)	---	● (See note 12.)	---	---
Event Input Assignment 2	---	---	---	---	---	● (See note 8.)	---	● (See note 12.)	---	---

Changed parameter Related initial- ized parameters	Input type	Temperature unit	Scaling Lower Limit Scaling Upper Limit	SP Lower Limit SP Upper Limit	Standard or Heating/ Cooling	Program Pattern	Transfer Output Type	Number of Multi-SP Uses	RT	SP0 to SP3 Set Point
Related parameter initialization execution condition		Temperature input	Analog input							
Move to Protect Level	---	---	---	---	---	---	---	---	---	---
MV Display Selection	---	---	---	---	●	---	---	---	---	---
Temperature Input Shift	---	---	---	---	---	---	---	---	---	---
Upper Limit Temperature Input Shift, Lower Limit Temperature Input Shift	---	---	---	---	---	---	---	---	---	---
Dead Band	---	---	---	---	---	---	---	---	---	---
Hysteresis (Heating)	---	---	---	---	---	---	---	---	---	---
Hysteresis (Cooling)	---	---	---	---	---	---	---	---	---	---
Wait Band	---	---	---	---	---	---	---	---	---	---
Alarm 1 to 3 Hysteresis	---	--	---	---	---	---	---	---	---	---
ST Stable Range	---	---	---	---	---	---	---	---	---	---
AT Hysteresis	---	● (See note 13.)	---	---	---	---	---	---	---	---
PV Stable Band	---	---	---	---	---	---	---	---	---	---
LBA Level	---	---	---	---	---	---	---	---	---	---
LBA Band	---	---	---	---	---	---	---	---	---	---

- Note**
- (1) Initialized to input setting range upper and lower limits, or scaling upper and lower limits.
 - (2) Clamped by SP upper and lower limits.
 - (3) Initialized only when the input type is changed to analog input when RT turns ON. The defaults are as follows:
RT: OFF
Proportional band: 8.0
Integral time: 233
Derivative time: 40
 - (4) Initialization is performed as shown below according to the transfer output type setting. The initialization differs depending on the changed parameter and the output type setting.
SP: SP upper and lower limits
Ramp SP: SP upper and lower limits
PV: Input setting range upper and lower limits or scaling upper and lower limits
MV (Heating): 100.0/0.0
MV (Cooling): 100.0/0.0
 - (4-1) Initialized only when the transfer output type is set to SP, Ramp SP, or PV.
 - (4-2) Initialized only when the transfer output type is set to MV (Heating) or MV (Cooling).

-
- (4-3) Initialized to the above default values regardless of the settings for changing the transfer output type.
- (5) Initialized as follows according to the Standard or Heating/Cooling parameter setting.
MV Upper Limit: 105.0
MV Lower Limit: Standard -5.0, heating/cooling -105.0
- (6) Initialized to control output (cooling) for heating and cooling control, according to the following. (The defaults for standard control are the defaults in the parameter list.)
With control output 2: The Control Output 2 Assignment parameter is initialized to control output (cooling).
Without control output 2 and E5AN/EN: The Auxiliary Output 3 Assignment parameter is initialized to control output (cooling).
Without control output 2 and E5CN: The Auxiliary Output 2 Assignment parameter is initialized to control output (cooling).
E5GN: The Auxiliary Output 1 Assignment parameter is initialized to control output (cooling).
- (7) When the program pattern is OFF, the Auxiliary Output 1 Assignment parameter is initialized to alarm output 1. When the program pattern is not OFF, the Auxiliary Output 1 Assignment parameter is initialized to program end output. The Auxiliary Output 1 Assignment parameter is not initialized for the E5GN, however, if it is set for heating/cooling control.
- (8) If the Program Start parameter is assigned when the program pattern is changed to OFF, the Program Start parameter will be initialized to "not assigned."
- (9) Initialized when temperature inputs are used and RT is changed. The defaults are as follows:
Proportional band: 8.0
Integral time: 233
Derivative time: 40 when RT is OFF, and 40.0 when RT is ON.
- (10) The proportional band, integral time, and derivative time are initialized as follows by RT and input type changes.
- When RT is turned from ON to OFF by a change from temperature input to analog input.
 - When ON is turned to OFF or OFF is turned to ON by an RT change.
- (11) Write to both so that the SP and the currently selected Multi-SP SP0 to SP3 match.
- (12) Initializes event input assignments used for Multi-SP to NONE.
- (13) Initialized to 0.8 when the temperature unit is °C, and to 1.4 when the temperature unit is °F.

Sensor Input Setting Range, Indication Range, Control Range

	Input type	Specifications	Set value	Input setting range	Input indication range
Controllers with Thermocouple/Resistance Thermometer Multi-inputs	Resistance thermometer	Pt100	0	-200 to 850 (°C)/-300 to 1,500 (°F)	-220 to 870 (°C)/-340 to 1,540 (°F)
			1	-199.9 to 500.0 (°C)/-199.9 to 900.0 (°F)	-199.9 to 520.0 (°C)/-199.9 to 940.0 (°F)
			2	0.0 to 100.0 (°C)/0.0 to 210.0 (°F)	-20.0 to 120.0 (°C)/-40.0 to 250.0 (°F)
		JPt100	3	-199.9 to 500.0 (°C)/-199.9 to 900.0 (°F)	-199.9 to 520.0 (°C)/-199.9 to 940.0 (°F)
			4	0.0 to 100.0 (°C)/0.0 to 210.0 (°F)	-20.0 to 120.0 (°C)/-40.0 to 250.0 (°F)
	Thermocouple	K	5	-200 to 1,300 (°C)/-300 to 2,300 (°F)	-220 to 1,320 (°C)/-340 to 2,340 (°F)
			6	-20.0 to 500.0 (°C)/0.0 to 900.0 (°F)	-40.0 to 520.0 (°C)/-40.0 to 940.0 (°F)
		J	7	-100 to 850 (°C)/-100 to 1,500 (°F)	-120 to 870 (°C)/-140 to 1,540 (°F)
			8	-20.0 to 400.0 (°C)/0.0 to 750.0 (°F)	-40.0 to 420.0 (°C)/-40.0 to 790.0 (°F)
		T	9	-200 to 400 (°C)/-300 to 700 (°F)	-220 to 420 (°C)/-340 to 740 (°F)
			10	-199.9 to 400.0 (°C)/-199.9 to 700.0 (°F)	-199.9 to 420.0 (°C)/-199.9 to 740.0 (°F)
		E	11	-200 to 600 (°C)/-300 to 1,100 (°F)	-220 to 620 (°C)/-340 to 1,140 (°F)
		L	12	-100 to 850 (°C)/-100 to 1,500 (°F)	-120 to 870 (°C)/-140 to 1,540 (°F)
		U	13	-200 to 400 (°C)/-300 to 700 (°F)	-220 to 420 (°C)/-340 to 740 (°F)
			14	-199.9 to 400.0 (°C)/-199.9 to 700.0 (°F)	-199.9 to 420.0 (°C)/-199.9 to 740.0 (°F)
		N	15	-200 to 1,300 (°C)/-300 to 2,300 (°F)	-220 to 1,320 (°C)/-340 to 2,340 (°F)
		R	16	0 to 1,700 (°C)/0 to 3,000 (°F)	-20 to 1,720 (°C)/-40 to 3,040 (°F)
		S	17	0 to 1,700 (°C)/0 to 3,000 (°F)	-20 to 1,720 (°C)/-40 to 3,040 (°F)
		B	18	100 to 1,800 (°C)/300 to 3,200 (°F)	0 to 1,820 (°C)/0 to 3,240 (°F)
	ES1B Infrared Temperature Sensor	10 to 70°C	19	0 to 90 (°C)/0 to 190 (°F)	-20 to 130 (°C)/-40 to 270 (°F)
		60 to 120°C	20	0 to 120 (°C)/0 to 240 (°F)	-20 to 160 (°C)/-40 to 320 (°F)
		115 to 165°C	21	0 to 165 (°C)/0 to 320 (°F)	-20 to 205 (°C)/-40 to 400 (°F)
		140 to 260°C	22	0 to 260 (°C)/0 to 500 (°F)	-20 to 300 (°C)/-40 to 580 (°F)
	Analog input	0 to 50 mV	23	Any of the following ranges, by scaling: -1,999 to 9,999 -199.9 to 999.9	-5% to 105% of setting range. The display shows -1999 to 9999 (numeric range with decimal point omitted).
	Thermocouple	W	24	0 to 2300 (°C)/0 to 3200 (°F)	-20 to 2320 (°C)/-40 to 3240 (°F)
PL-II		25	0 to 1300 (°C)/0 to 2300 (°F)	-20 to 1320 (°C)/-40 to 2340 (°F)	

	Input type	Specifications	Set value	Input setting range	Input indication range
Controllers with Analog Inputs	Current input	4 to 20 mA	0	Any of the following ranges, by scaling: –1,999 to 9,999 –199.9 to 999.9 –19.99 to 99.99 –1.999 to 9.999	–5% to 105% of setting range. The display shows –1999 to 9999 (numeric range with decimal point omitted).
		0 to 20 mA	1		
	Voltage input	1 to 5 V	2		
		0 to 5 V	3		
		0 to 10 V	4		

- The default is 5 (°C/°F) for Controllers with Thermocouple/Resistance Thermometer Universal Inputs and 0 for Controllers with Analog Inputs.
- The applicable standards for each of the above input ranges are as follows:
K, J, T, E, N, R, S, B: JIS C1602-1995, IEC 584-1
L: Fe-CuNi, DIN 43710-1985
U: Cu-CuNi, DIN 43710-1985
W: W5Re/W26Re, ASTM E988-1990
JPt100: JIS C 1604-1989, JIS C 1606-1989
Pt100: JIS C 1604-1997, IEC 751
PLII: According to Platinel II Electromotive Force Table by Engelhard Corp.

Control Range

- Resistance thermometer and thermocouple input
Temperature lower limit -20°C to temperature upper limit $+20^{\circ}\text{C}$, or temperature lower limit -40°F to temperature upper limit $+40^{\circ}\text{F}$
- ES1B input:
Same as input indication range
- Analog input
–5% to +105% of scaling range

Setting Levels Diagram

This diagram shows all of the setting levels. To move to the advanced function setting level and calibration level, you must enter passwords. Some parameters are not displayed depending on the protect level setting and the conditions of use.

Control stops when you move from the operation level to the initial setting level.

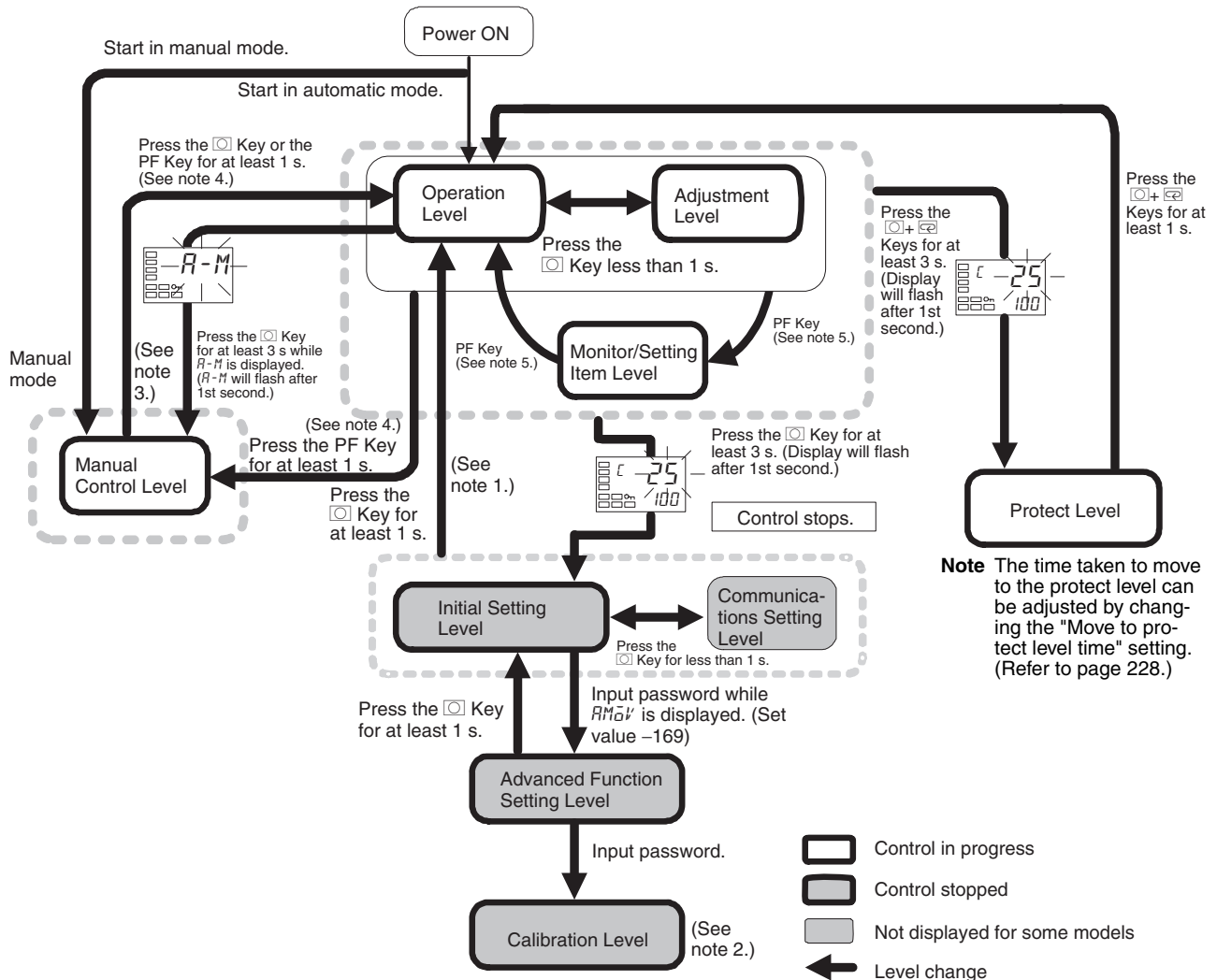

- Note**
- (1) You can return to the operation level by executing a software reset.
 - (2) It is not possible to move to other levels from the calibration level by operating the keys on the front panel. It can be done only by first turning OFF the power.
 - (3) From the manual control level, key operations can be used to move to the operation level only.
 - (4) When the PF Setting parameter is set to A-M for a Controller with a PF Key (E5AN/EN).
 - (5) When the PF Setting parameter is set to PFDP for a Controller with a PF Key (E5AN/EN)

Parameter Flow

This section describes the parameters set in each level. Pressing the Key at the last parameter in each level returns to the top parameter in that level.

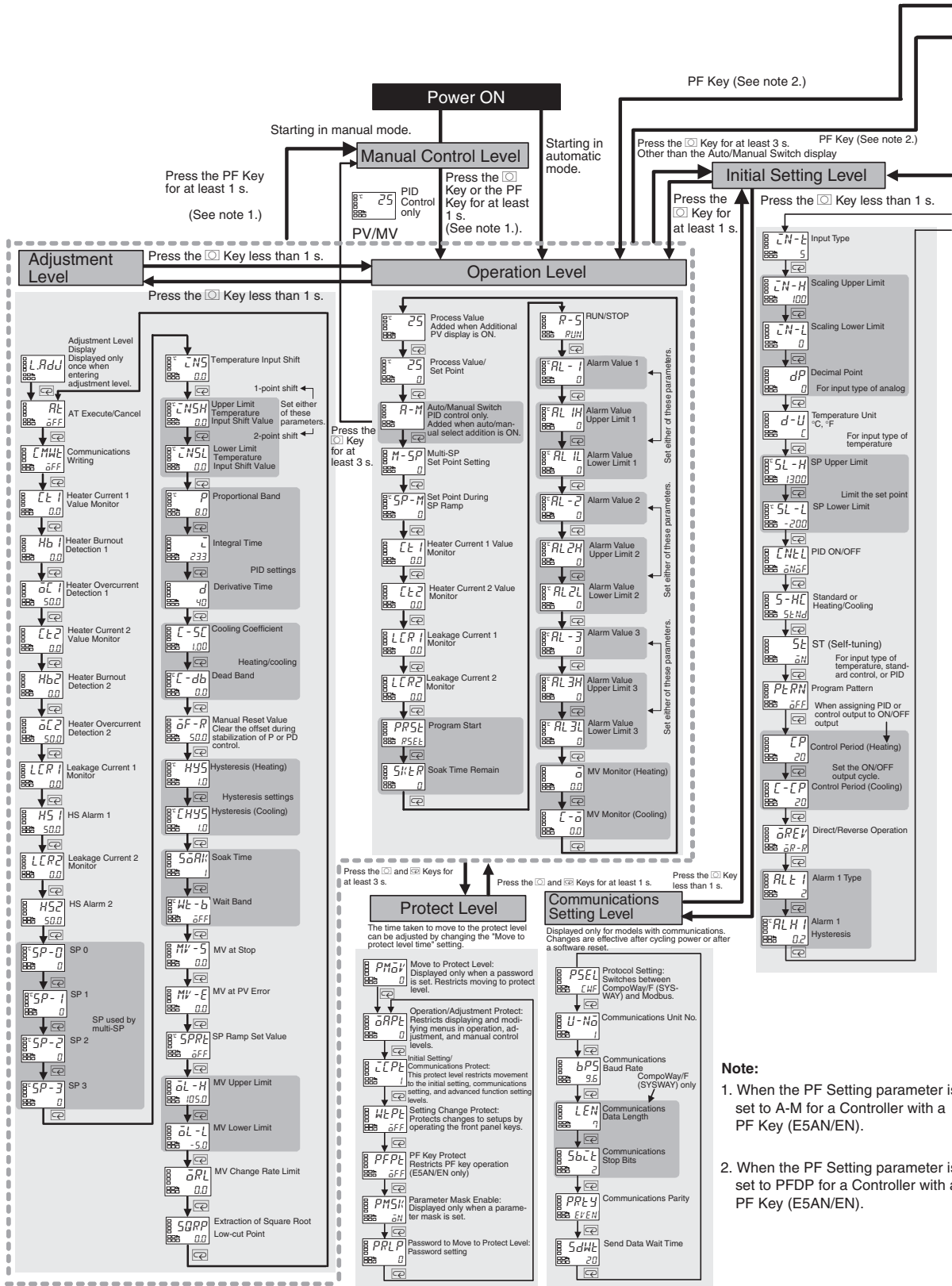

- Note:**
1. When the PF Setting parameter is set to A-M for a Controller with a PF Key (E5AN/EN).
 2. When the PF Setting parameter is set to PFDP for a Controller with a PF Key (E5AN/EN).

Monitor/Setting Item Level (E5AN/EN only)

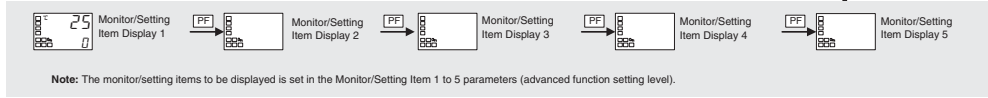

Press the  Key for at least 1 s.

Advanced Function Setting Level

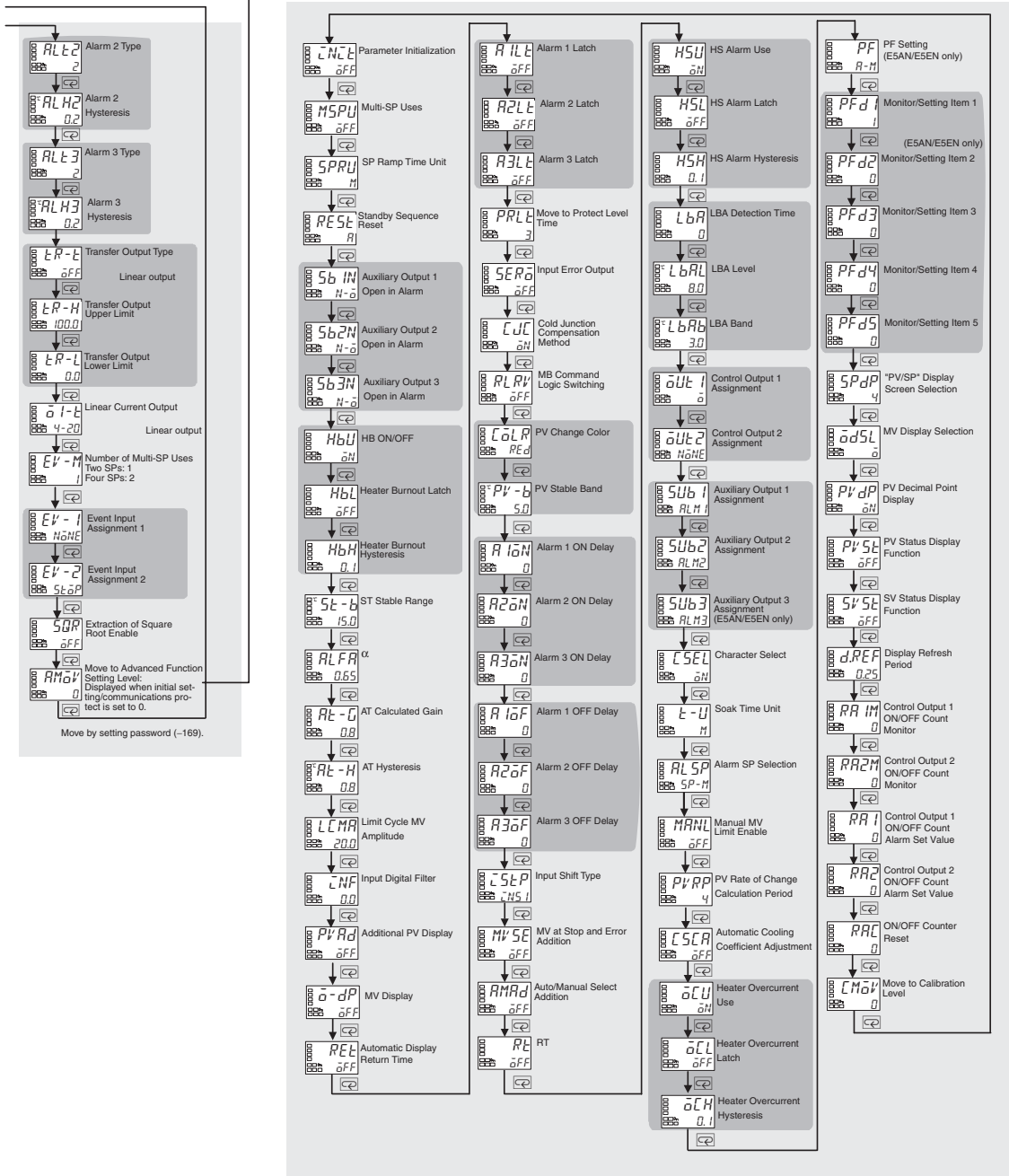

Index

Numerics

2-PID control, 54, 204

A

adjustment level, 16, 177
 parameter operation list, 289
advanced function setting level, 17, 218
 moving to, 108
 parameter operation list, 294
alarm delays, 116
alarms, 13
 alarm delays, 116
 alarm hysteresis, 93
 alarm latch, 94
 alarm outputs, 69
 alarm types, 69
 alarm values, 71
 operation, 94
analog input, 94, 272
 calibration, 265, 267
AT (auto-tuning), 62
auto control, 103
auto/manual select addition, 124, 234
auto/manual switch, 166
auxiliary output 1 assignment, 240
auxiliary output 2 assignment, 241
auxiliary output 3 assignment, 242
auxiliary outputs 1, 2 and 3, 40
 wiring, 41

B

basic model
 E5AN, 9
 E5CN, 6
 E5CN-U, 7
 E5EN, 9
 E5GN, 11

C

calibration
 analog input, 265, 267
 current input, 267
 indication accuracy, 270
 input types, 260

 platinum resistance thermometer, 264
 registering calibration data, 260
 thermocouple, 260
 user calibration, 260
 voltage input, 268

characteristics, 277

cold junction compensator
 connecting, 261

communications
 operation commands, 112
 wiring
 RS-232C, 44
 RS-485, 42

communications function, 14

communications setting level, 17, 255
 parameter operation list, 299

control outputs, 13
 control outputs 1 and 2
 wiring, 37, 39

control periods, 54, 206

Controllers with Analog Input, 267

Controllers with Analog Inputs, 259, 268

Controllers with Thermocouple/Resistance Thermometer
Universal Input, 258, 265

cooling coefficient
 setting, 98

current input
 calibration, 267

current transformer
 calculating detection current, 75

Current Transformers (CT), 74, 279

 CT inputs
 wiring, 42
 external dimensions, 279
 E54-CT1, 279
 E54-CT3, 279
 specifications, 278, 279

Current Value Exceeds (error display), 282

D

dead band, 97
 setting, 98

derivative time, 68

detection current, 75

dimensions, 22
 E5AN, 22
 E5CN, 22

E5CN-U, 22
E5EN, 22
E5GN, 23
direct operation, 55, 206
Display Range Exceeded (error display), 281
down key, 5

E

error displays, 281
 Current Value Exceeds, 282
 Display Range Exceeded, 281
 Heater Burnout, 283
 Heater Overcurrent, 283
 HS Alarm, 283
 Input Error, 281
 Memory Error, 282
event inputs, 13, 41, 99, 101
 wiring, 41
external dimensions
 Current Transformer (CT), 279
external power supply for ES1B, 14, 44, 90, 276

F

front panel
 E5AN, 2
 E5CN, 2
 E5CN-U, 2
 E5EN, 3
 E5GN, 3

H

HB alarm (heater burnout alarm), 73
 settings, 80
Heater Burnout (error display), 283
heater burnout alarm, 13, 276
heater burnout hysteresis, 223
heater burnout latch, 223
heater overcurrent
 hysteresis, 247
 latch, 246
heating/cooling control, 95, 189, 193, 204
 cooling coefficient, 97, 189
 dead band, 97, 189
 setting, 98
HS alarm, 13, 73, 276

 settings, 82
HS Alarm (error display), 283
hysteresis, 60, 62

I

I/O configuration, 6
 basic model
 E5AN, 9
 E5CN, 6
 E5CN-U, 7
 E5EN, 9
 E5GN, 11
 main functions, 12
indication accuracy, 270
indicators
 explanation, 4
 operation, 4
infrared temperature sensor, 270
initial setting level, 17, 199
 parameter operation list, 291
initial setting/communications protect, 110
initial settings, 50
 examples, 50, 51
initialization, 220
Input Error (error display), 281
input sensor types, 12, 200
input shift, 89
 one-point shift, 89
 two-point shift, 90
 calculating, 90
input types, 52, 303
 default values, 200
 list, 53
 setting, 52
inputs
 wiring, 36
installation, 22, 25
 E5AN/E5EN
 mounting the terminal cover, 26
 mounting to the panel, 26
 E5CN/E5CN-U
 mounting the terminal cover, 26
 mounting to the panel, 25
 E5GN
 mounting to the panel, 27
panel cutout
 E5AN, 24
 E5CN, 24

- E5CN-U, 24
- E5EN, 24
- E5GN, 25
- removing from case
 - E5AN, 29
 - E5CN, 28
 - E5EN, 29
- removing the terminal block
 - E5GN, 30

integral time, 68, 188

K

keys

- down key, 5
- key operations, 15
- level key, 5
- mode key, 5
- operations, 5
- up key, 5

L

LBA (loop burnout alarm), 118

- band, 119
- detection time, 119, 120
- level, 119, 120

level key, 5

loop burnout alarm (LBA), 118

M

main functions, 12

manual control, 103, 122

manual control level, 16

- moving to, 123
- parameter operation list, 294

manual setup, 68

Memory Error (error display), 282

mode key, 5

mounting, 25

- terminal cover
 - E5AN/E5EN, 26
 - E5CN/E5CN-U, 26
- to panel
 - E5AN/E5EN, 26
 - E5CN/E5CN-U, 25
 - E5GN, 27

multi-SP, 101, 167

MV at PV error, 137, 233

MV at stop, 136, 233

N

No. 1 display, 4

No. 2 display, 4

O

ON/OFF control, 54, 204

- setting, 61

one-point shift, 91

operation level, 16, 163

- parameter operation list, 288

operation/adjustment protect, 110

output functions

- assignments, 56

output limits, 136

output periods, 206

output specifications

- setting, 54

P

panel cutout

- E5AN, 24
- E5CN/E5CN-U, 24
- E5EN, 24
- E5GN, 25

parameter flow, 305

parameter operation list, 288

- adjustment level, 289
- manual control level, 294
- operation level, 288

parameter operation lists

- advanced function setting level, 294
- communications setting level, 299
- initial setting level, 291
- protect level, 299

parameter structure, 258

parameters

- additional PV display, 226
- adjustment level display, 179
- alarm 1 hysteresis, 209
- alarm 1 latch, 227
- alarm 1 OFF delay, 232
- alarm 1 ON delay, 232

- alarm 1 type, 207
- alarm 2 hysteresis, 209
- alarm 2 latch, 227
- alarm 2 OFF delay, 232
- alarm 2 ON delay, 232
- alarm 2 type, 209
- alarm 3 hysteresis, 209
- alarm 3 latch, 227
- alarm 3 OFF delay, 232
- alarm 3 ON delay, 232
- alarm 3 type, 210
- alarm SP selection, 244
- alarm value 1, 172
- alarm value 2, 173
- alarm value 3, 173
- alarm value lower limit 1, 174
- alarm value lower limit 2, 174
- alarm value lower limit 3, 175
- alarm value upper limit 1, 174
- alarm value upper limit 2, 174
- alarm value upper limit 3, 175
- alpha, 224
- AT calculated gain, 225
- AT execute/cancel, 179
- AT hysteresis, 225
- auto/manual select addition, 234
- auto/manual switch, 166
- automatic cooling coefficient adjustment, 245
- automatic display return time, 227
- auxiliary output 1 assignment, 240
- auxiliary output 1 open in alarm, 222
- auxiliary output 2 assignment, 241
- auxiliary output 2 open in alarm, 222
- auxiliary output 3 assignment, 242
- auxiliary output 3 open in alarm, 222
- character select, 243
- cold junction compensation method, 229
- communications baud rate, 255
- communications data length, 255
- communications parity, 255
- communications stop bits, 255
- communications Unit No., 255
- communications writing, 180
- control output 1 assignment, 238
- control output 1 ON/OFF count alarm set value, 253
- control output 1 ON/OFF count monitor, 252
- control output 2 assignment, 239
- control output 2 ON/OFF count alarm set value, 253
- control output 2 ON/OFF count monitor, 252
- control period (cooling), 206
- control period (heating), 206
- cooling coefficient, 189
- dead band, 189
- decimal point, 202
- derivative time, 188
- direct/reverse operation, 206
- display refresh period, 251
- event input assignment *, 216
- extraction of square root enable, 216
- extraction of square root low-cut point, 194
- HB ON/OFF, 222
- heater burnout detection 1, 181
- heater burnout detection 2, 183
- heater burnout hysteresis, 223
- heater burnout latch, 223
- heater current 1 value monitor, 168, 180
- heater current 2 value monitor, 169, 182
- heater overcurrent detection 1, 181
- heater overcurrent detection 2, 183
- heater overcurrent hysteresis, 247
- heater overcurrent latch, 246
- heater overcurrent use, 246
- HS alarm 1, 184
- HS alarm 2, 185
- HS alarm hysteresis, 236
- HS alarm latch, 235
- HS alarm use, 235
- hysteresis (cooling), 190
- hysteresis (heating), 190
- initial setting/communications protect, 160
- input digital filter, 226
- input error output, 228
- input shift type, 233
- input type, 200
- integral time, 188
- LBA band, 237
- LBA detection time, 236
- LBA level, 237
- leakage current 1 monitor, 170, 184
- leakage current 2 monitor, 170, 185
- limit cycle MV amplitude, 225
- linear current output, 212
- lower-limit temperature input shift value, 187
- manual MV limit enable, 244
- manual reset value, 190
- MB command logic switching, 229
- monitor/setting item *, 248
- monitor/setting item display 1 to 5, 196
- move to advanced function setting level, 217
- move to calibration level, 254
- move to protect level, 160
- move to protect level time, 228
- multi-SP set point setting, 167
- multi-SP uses, 220

- MV (manual MV), 197
- MV at PV error, 192
- MV at stop, 192
- MV at stop and error addition, 233
- MV change rate limit, 194
- MV display, 227
- MV display selection, 249
- MV lower limit, 193
- MV monitor (cooling), 176
- MV monitor (heating), 175
- MV upper limit, 193
- number of multi-SP uses, 213
- ON/OFF counter reset, 254
- operation/adjustment protect, 160
- parameter initialization, 220
- parameter mask enable, 161
- password to move to protect level, 162
- PF key protect, 161
- PF setting, 247
- PID ON/OFF, 204
- process value, 165
- process value/set point, 165
- program pattern, 205
- program start, 171
- proportional band, 188
- protocol setting, 255
- PV change color, 230
- PV decimal point display, 250
- PV rate of change calculation period, 245
- PV stable band, 231
- PV status display function, 250
- PV/MV (manual MV), 197
- PV/SP display screen selection, 249
- RT, 234
- RUN/STOP, 172
- scaling lower limit, 202
- scaling upper limit, 202
- selecting, 17
- send data wait time, 255
- set point during SP ramp, 167
- setting change protect, 161
- soak time, 191
- soak time remain, 171
- soak time unit, 243
- SP 0, 186
- SP 1, 186
- SP 2, 186
- SP 3, 186
- SP lower limit, 203
- SP ramp set value, 193
- SP ramp time unit, 220
- SP upper limit, 203
- ST (self-tuning), 205
- ST stable range, 224
- standard or heating/cooling, 204
- standby sequence reset, 221
- SV status display function, 251
- temperature input shift, 186
- temperature unit, 202
- transfer output lower limit, 212
- transfer output type, 210
- transfer output upper limit, 212
- upper-limit temperature input shift value, 187
- wait band, 191
- part names, 2
- password, 111, 112
- PID constants, 62, 65
 - setting manually, 68
- PID control
 - setting, 61
- PID ON/OFF
 - Page, 193
- platinum resistance thermometer, 271
 - calibration, 264
- power supply
 - wiring, 35
- precautions
 - wiring, 33
- process value (PV), 165
- program end, 132
 - output, 132
- program patterns, 130
- proportional action, 68
- proportional band, 68
- protect level, 16, 110, 159
 - moving to, 112, 160, 228
 - communications operation command, 112
 - password, 111, 162
 - parameter operation list, 299
- protection, 110
 - initial setting/communications, 110, 160
 - operation/adjustment, 110, 160
 - setting change, 110, 111
- PV display
 - color change, 113
 - stable band, 114
- PV/MV, 197

R

- ratings, 275

removing from case
 E5AN/E5EN, 29
 E5CN, 28
removing the terminal block
 E5GN, 30
reverse operation, 55, 206
RT (robust tuning), 66, 234
run/stop control, 103

S

scaling
 upper and lower limits for analog inputs, 94
screwless clamp terminals, 34
self-tuning (ST), 64, 205
sensor input
 control range, 303
 indication range, 303
 setting range, 303
sensor types, 200
set point (SP), 59
 limiter, 104
 limiting change rate, 106
 lower limit, 106
 ramp, 106
 setting, 59, 61
 setting upper and lower limits, 104
 switching between SPs, 102
 upper limit, 105
setting change protect, 110
setting level configuration, 15
setting levels
 diagram, 305
settings
 cooling coefficient, 98
 dead band, 98
 event input, 99
 HB alarm (heater burnout alarm), 80
 moving to advanced function setting level, 80
 heating/cooling control, 98
 HS alarm, 82
 moving to advanced function setting level, 81, 82
 hysteresis, 62
 LBA detection time, 119
 password, 112
 PID ON/OFF, 61
 saving, 18
 SP lower limit, 106
 SP upper limit, 105

 switching between SPs, 102
shifting input values, 89
simple program function, 129, 135
 controlling start, 103
 starting, 131
soak time, 131
SP ramp, 106
 alarm operations, 108
 operation at startup, 107
 restrictions, 107
specifications, 275
 Current Transformer (CT), 278, 279
 external power supply for ES1B, 45
 output, 54
 USB-Serial Conversion Cable, 280
ST (self-tuning), 64
 ST stable range, 65
 startup conditions, 65
standard control, 204
standby sequence, 93
startup
 conditions, 65
 operation, 107
support software port, 45

T

temperature input, 12, 13
 shift values, 93
temperature unit, 4, 54
terminals
 arrangement
 E5AN/E5EN, 32
 E5CN, 31
 E5CN-U, 32, 33
 wiring, 31
thermocouple, 270
 calibration, 260
Thermocouple/Resistance Thermometer
 input type, 264, 265
 universal input type, 265
three-position control, 60
transfer output, 126
 type, 127
troubleshooting, 284
two-point shift, 90, 92, 93
 calculating, 90

U

up key, 5

USB-Serial Conversion Cable

specifications, 280

user calibration, 260

V

voltage input

calibration, 268

W

wait band, 131

wiring, 35

auxiliary outputs 1, 2, and 3, 40

communications

RS-232C, 44

RS-485, 42

control output 1, 37

control output 2, 39

CT inputs, 42

event inputs, 41

external power supply for ES1B, 44

inputs, 36

power supply, 35

precautions, 33

terminal arrangement, 31

terminals, 31

Revision History

A manual revision code appears as a suffix to the catalog number on the front cover of the manual.

Cat. No. H156-E1-03

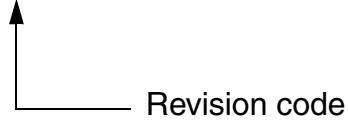

The following table outlines the changes made to the manual during each revision. Page numbers refer to the previous version.

Revision code	Date	Revised content
01	January 2008	Original production
01A	March 2008	Page 9: Added case color information to the model number legend.
02	March 2009	Pages xii and xiv: Added information on shipping standards and corrected mistakes. Pages 26, 96,236, 246, 255, 263, and 277: Made minor corrections. Pages 62 to 67: Made minor corrections to graphics. Page 80: Replaced graphic and changed step 2.
03	September 2009	Added the E5GN.

OMRON Corporation
Industrial Automation Company
Control Devices Division H.Q.
Industrial Component Division

2-2-1 Nishikusatsu, Kusatsu-shi,
Shiga, 525-0035 Japan
Tel: (81) 77-565-5160/Fax: (81) 77-565-5569

Regional Headquarters

OMRON EUROPE B.V.
Wegalaan 67-69-2132 JD Hoofddorp
The Netherlands
Tel: (31)2356-81-300/Fax: (31)2356-81-388
OMRON Industrial Automation Global: www.ia.omron.com

OMRON ELECTRONICS LLC

One Commerce Drive Schaumburg,
IL 60173-5302 U.S.A.
Tel: (1) 847-843-7900/Fax: (1) 847-843-7787

OMRON ASIA PACIFIC PTE. LTD.

No. 438A Alexandra Road # 05-05/08 (Lobby 2),
Alexandra Technopark, Singapore 119967
Tel: (65) 6835-3011/Fax: (65) 6835-2711

OMRON (CHINA) CO., LTD.

Room 2211, Bank of China Tower,
200 Yin Cheng Zhong Road,
PuDong New Area, Shanghai, 200120, China
Tel: (86) 21-5037-2222/Fax: (86) 21-5037-2200

Authorized Distributor:

© OMRON Corporation 2008 All Rights Reserved.
In the interest of product improvement,
specifications are subject to change without notice.

Cat. No. H156-E1-03

Printed in Japan
0909